



1



Il y a bien longtemps

Il était une fois un grand château. Avec de vaillants chevaliers, des chevaux, des rois, des reines et des tournois. Et beaucoup d'aventures, chaque jour.

C'est ainsi que commençait la description de l'emblématique

set 375 Le château dans le catalogue de produits LEGO®, lors de son lancement en 1978. Souvent appelé le « château jaune » ou le « château original », il a marqué le début d'une fantastique aventure médiévale, qui s'est poursuivie jusqu'en

1999. Dans le cadre des célébrations du 90^e anniversaire de LEGO, nous avons choisi de rendre hommage à ce thème populaire avec le nouveau château des Chevaliers du lion, inspiré du set classique 6080 Le château du roi, lancé en 1984.

1978



375 Le château

Le château original avec lequel tout a commencé ! Les murs jaune vif de ce château étaient articulés pour permettre de créer de multiples configurations et d'accéder facilement à l'intérieur. Bien que le jaune ait été rapidement abandonné au profit d'un gris plus réaliste, la conception des murs à charnières est toujours présente dans les châteaux LEGO aujourd'hui.

Parmi les curiosités de ce modèle se trouvent les chevaux en briques et le casque spatial classique muni d'une nouvelle visière, qui fait office de casque pour les chevaliers.

1984



6080 Le château du roi

1986



6074 La forteresse du Faucon Noir

1987



6066 Avant-poste camouflé

La cachette secrète originale des hommes de la forêt ! Un vieux chêne enlace ses racines autour d'un rocher géant, mais ce lieu recèle bien des surprises ! Une porte secrète rotative en pierre permet d'accéder à la grotte des hommes de la forêt, et le panneau arrière à charnières s'ouvre pour révéler l'espace de jeu à l'intérieur. Ce set comprend 6 hommes de la forêt différents, dont leur chef énigmatique.

1992



6086 Le château du chevalier noir

Le summum des châteaux classiques ! Cette impressionnante forteresse est construite sur une plaque de base surélevée, laissant place à un cachot sous la cour. Le château perpétue la tradition en incluant un pont-levis et une herse fonctionnels, et il contient également une porte arrière secrète pour les évasions rapides ou les excursions nocturnes. Le château du Chevalier noir hébergeait 4 chevaliers en armure à cheval, 6 soldats, un bandit de la bandes des loups et même un fantôme !

1992



6038 La voiture de la bande des loups

1997



6097
Le château du seigneur de la nuit

2000

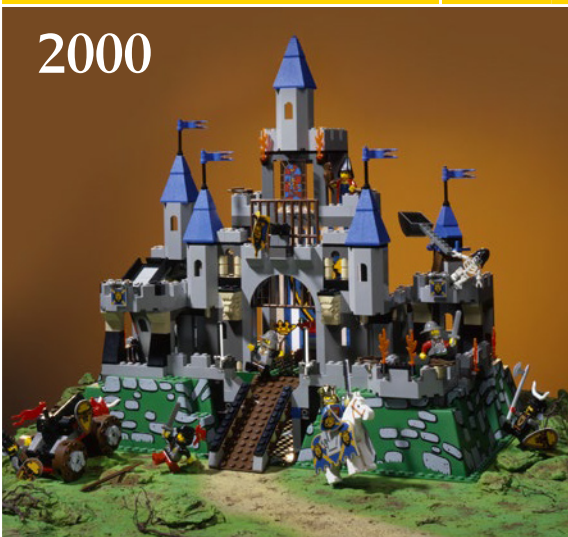

6091
Le château du roi Léo

2004



8781
Le château de Morcia

2009



10193 Le village médiéval

Le village médiéval est l'un des rares sets à montrer la vie au-delà des murs du château. Il comprend deux bâtiments à colombages magnifiquement détaillés, une roue à eau pour alimenter le marteau-pilon de la forge, des soldats, des écuries, une charrette tirée par des chevaux et même deux vaches !

2016



70317
Le Fortrex

Un château classique d'un nouveau genre

C'est toujours un défi de réinventer un thème LEGO® si apprécié, mais notre nouveau château des Chevaliers du lion associe une construction LEGO de plus grande complexité à l'esprit des sets originaux, comme Le château du roi (6080), pour créer un modèle riche en caractéristiques et fonctions amusantes.

Nous avons commencé par placer la tour principale au sommet d'une grande formation rocheuse LEGO, afin que le modèle semble plus grand. Cela nous a également permis d'inclure des pièces cachées et des cachots sombres sous le château. Les murs sont mobiles, et le modèle peut être divisé pour mieux accéder au château et révéler une multitude de trappes, de passages secrets et de cachettes.

2022



Cette nouvelle interprétation du château classique tire parti des techniques de construction modernes et présente de nombreuses caractéristiques qui rendent hommage aux sets de château originaux.

À l'occasion du 90^e anniversaire de LEGO en 2022, nous avons demandé aux fans de voter pour les thèmes LEGO classiques qu'ils souhaitaient voir renaître dans un set spécial. Des dizaines de milliers de fans ont participé au sondage et le thème Château classique a été l'un des grands gagnants !

90 years of play

LEGO YELLOW CASTLE, 1978

Les mots de l'équipe de design

Lorsqu'ils étaient enfants, le thème Château faisait toujours partie de ceux qu'ils préféraient. Les designers LEGO® Mike Psiaki et Milan Madge ont donc toujours rêvé de travailler ensemble sur un grand set de château LEGO. Mike décrit l'évolution du modèle :

Ce modèle a été élu lors d'un vote qui s'est déroulé dans le cadre des célébrations du 90^e anniversaire de LEGO en 2022. Nous avons essayé de fusionner un grand nombre de sets du passé sur le thème des châteaux pour créer le modèle ultime. Nous avons revisité à plusieurs reprises la forme globale et la taille du château. Nous avons commencé à construire de petites sections de murs, des portes en colombage et des ponts-levis, en jouant avec différentes fonctions et styles pour tenter d'obtenir le modèle idéal. Au début du projet, Milan a découvert un type de pont-levis qui utilisait un contrepoids à l'arrière du pont au lieu des chaînes traditionnelles reliées à l'avant du pont. Nous avons immédiatement su que nous voulions intégrer cet élément dans le château, mais ce n'est que très tard qu'il est devenu l'entrée principale.

Le graphiste LEGO Ashwin Visser a ensuite joué un rôle central dans la réalisation de nombreuses petites touches cruciales qui complètent le set. Nous avons notamment retravaillé le graphisme des Chevaliers du lion, créé de nouveaux drapeaux et boucliers pour les murs et les remparts du château, et introduit l'élément de caparaçon (housse revêtue par les chevaux) bleu et rouge pour les deux chevaux. Pour finir, nous avons conçu une nouvelle cape et un nouveau bouclier pour la dame du château.

1984



2022



Repérez la différence

Nous avons décidé de transformer les Chevaliers du lion LEGO classiques pour faire en sorte qu'ils s'accordent avec les nouveaux Chevaliers du Faucon Noir, qui sont apparus dans le set médiéval 21325 Le forgeron. Cela a été un véritable défi de recréer le nouveau logo des Chevaliers du lion, car celui-ci se devait d'être une nouvelle version reconnaissable du logo emblématique que les fans affectionnent.

Ashwin Visser, LEGO Graphic Designer



De gauche à droite
Michael Psiaki, LEGO® Design Master
Milan Madge, LEGO® Designer
Ashwin Visser, LEGO® Graphic Designer

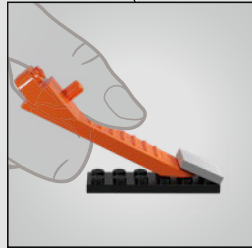
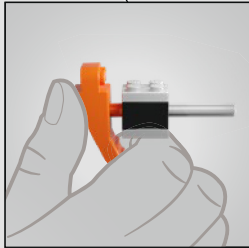
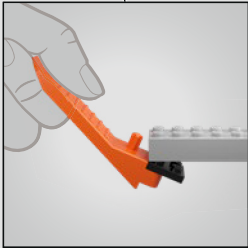
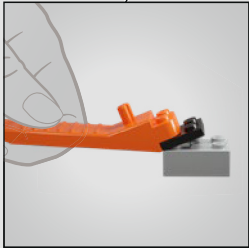
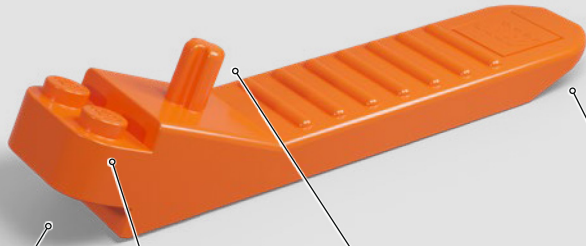

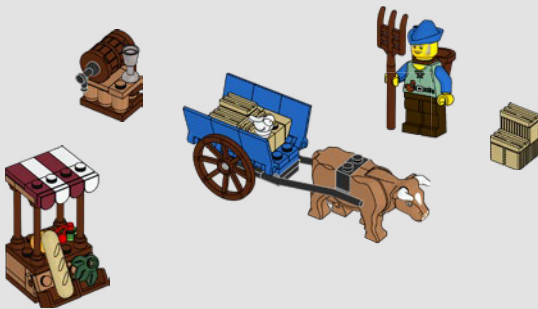
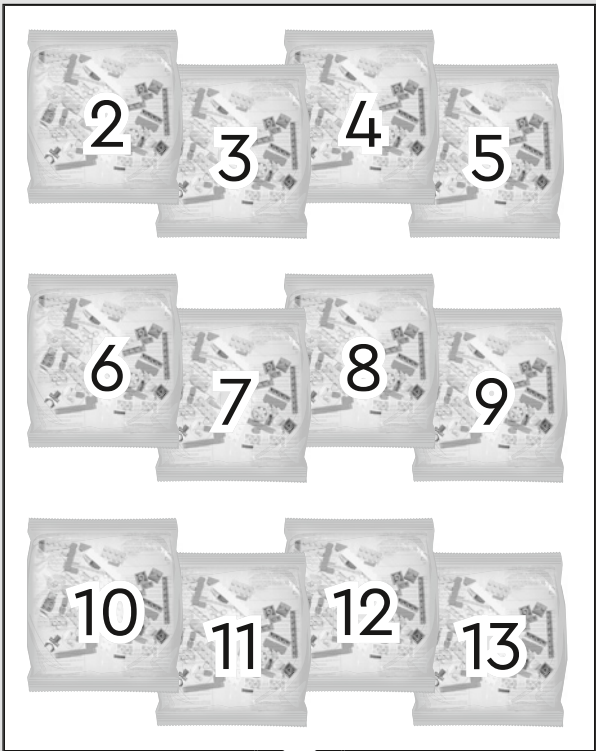

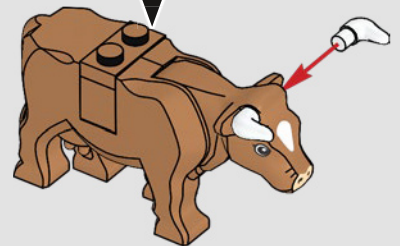
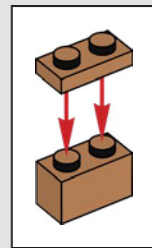
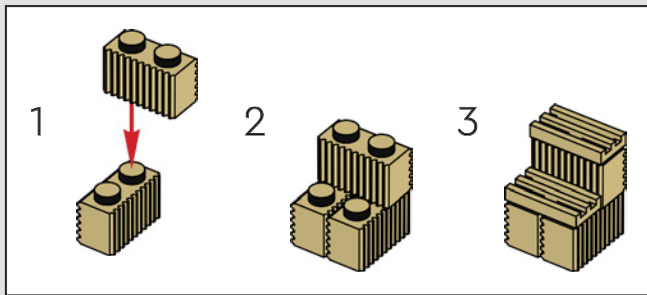
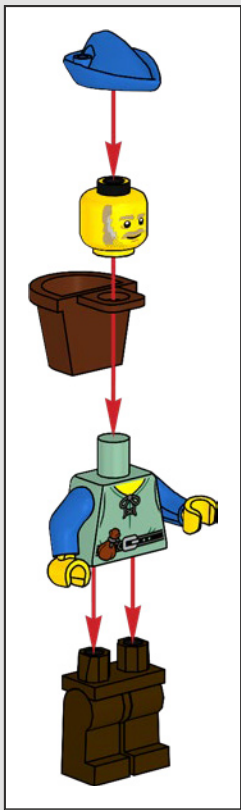

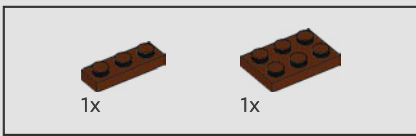

1

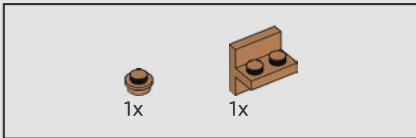
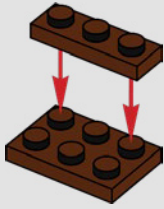

2

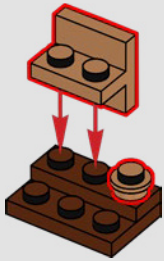

3

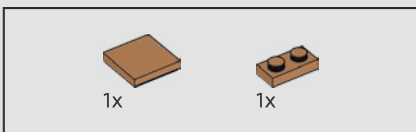
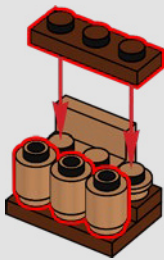

4

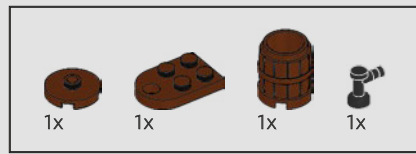
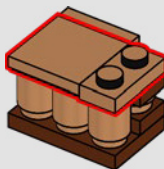

5

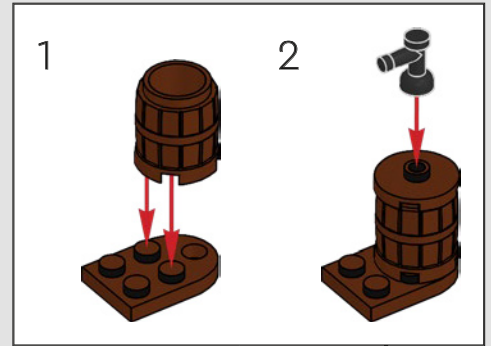

6



Ce fût contient une boisson si puissante qu'elle pourrait blanchir une barbe !

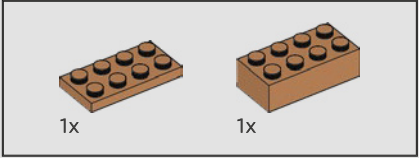
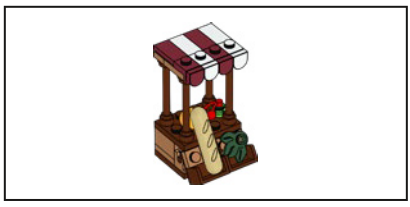

1

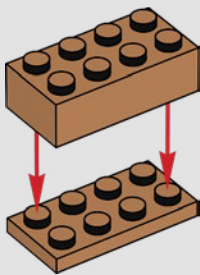

2

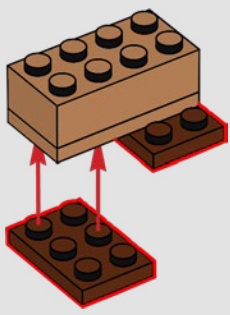

3

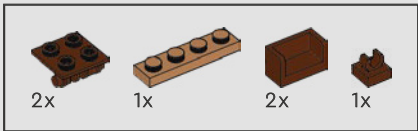
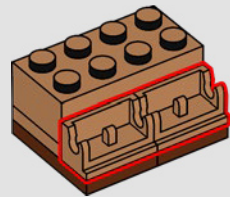

4

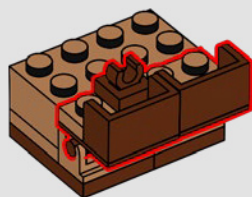
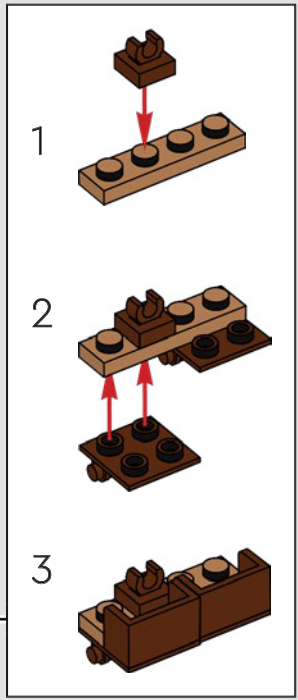

5

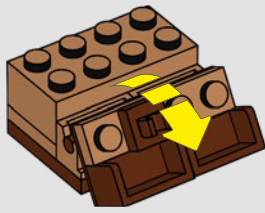

6

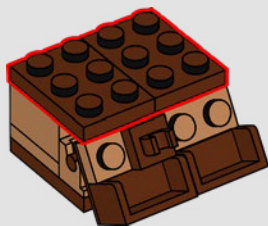

7

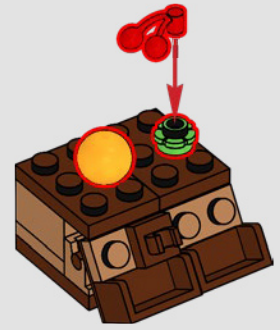
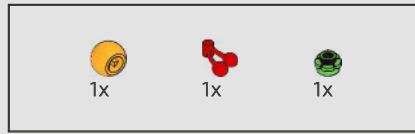

8

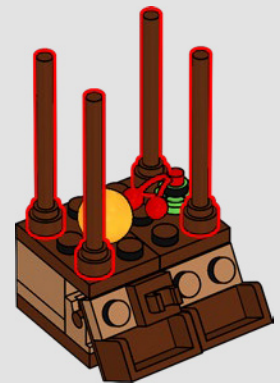

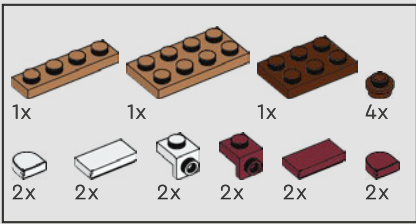

9

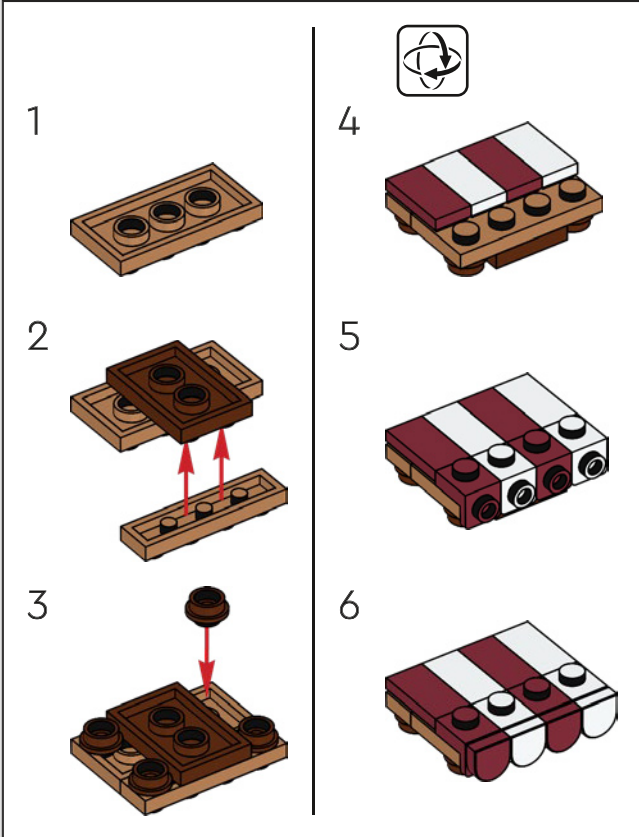

10

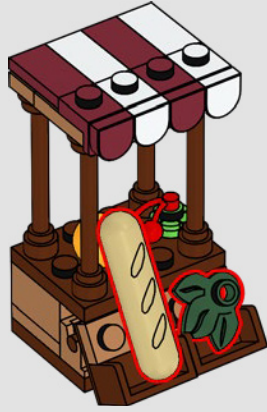

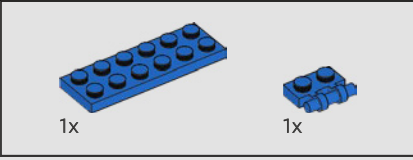
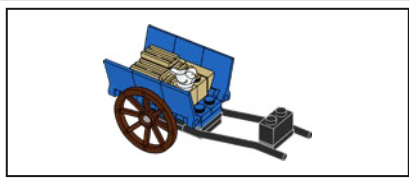

1

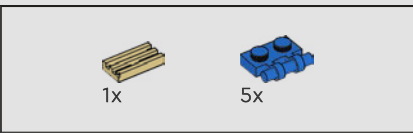
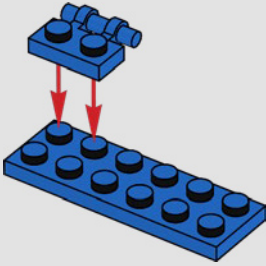

2

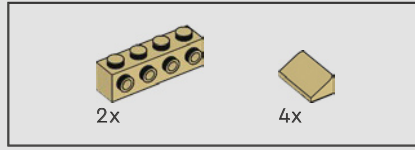
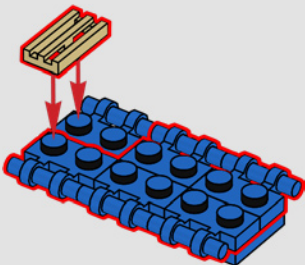

3

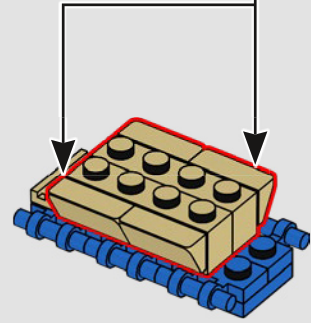
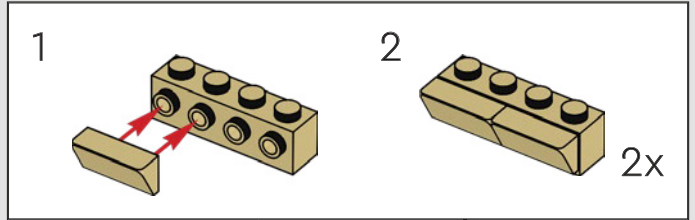

4

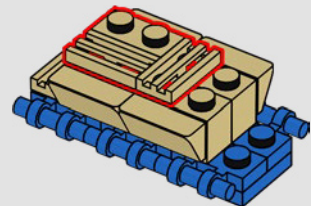

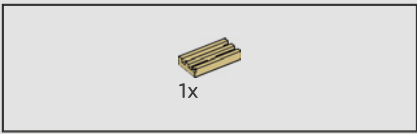

5

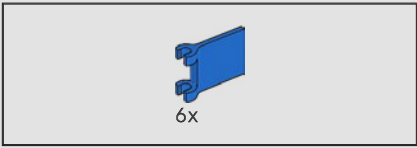
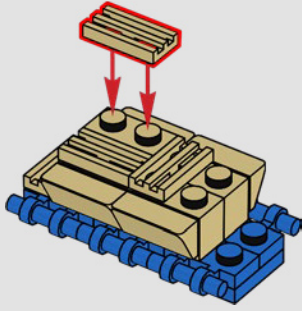

6

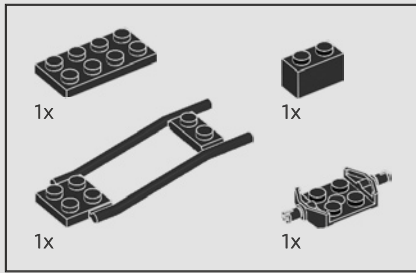
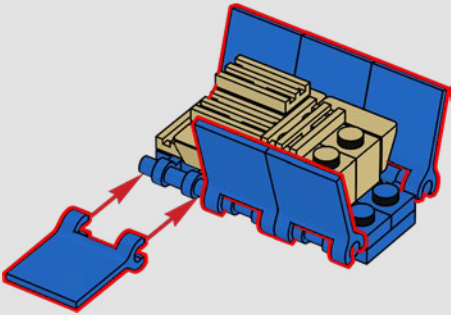

7

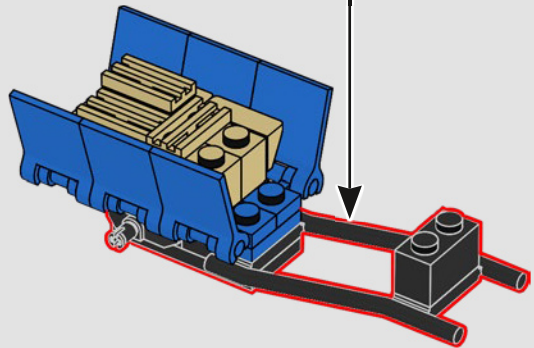
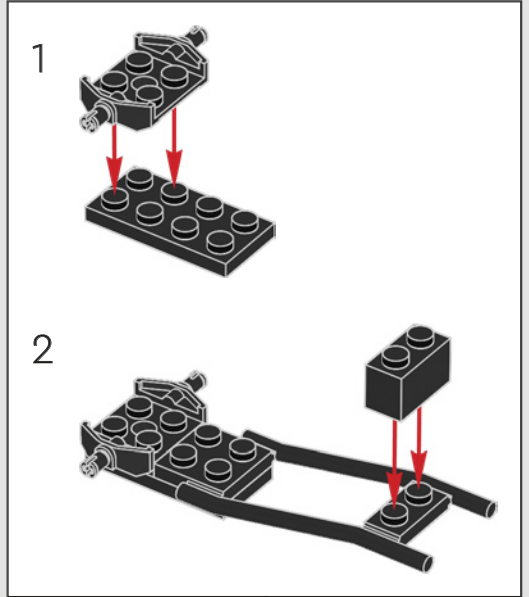



*Ce chariot est tiré par des bœufs ?
Cette bizarrerie me rappelle le bateau à
vent de la cousine Willa.*

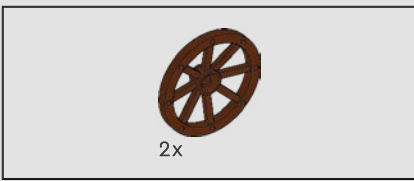

8

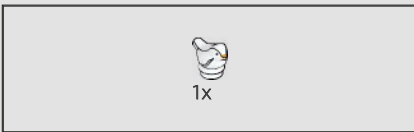
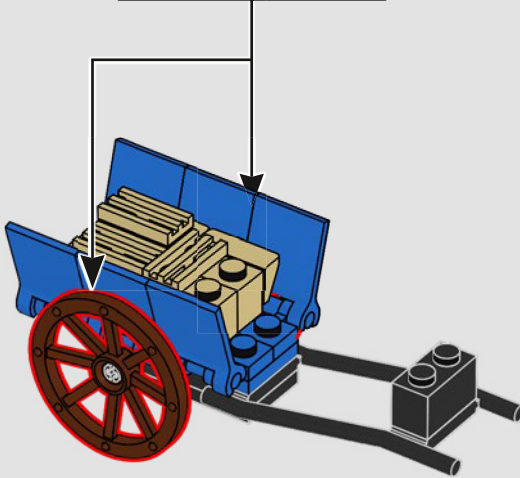
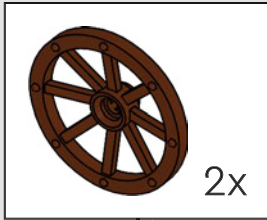

9

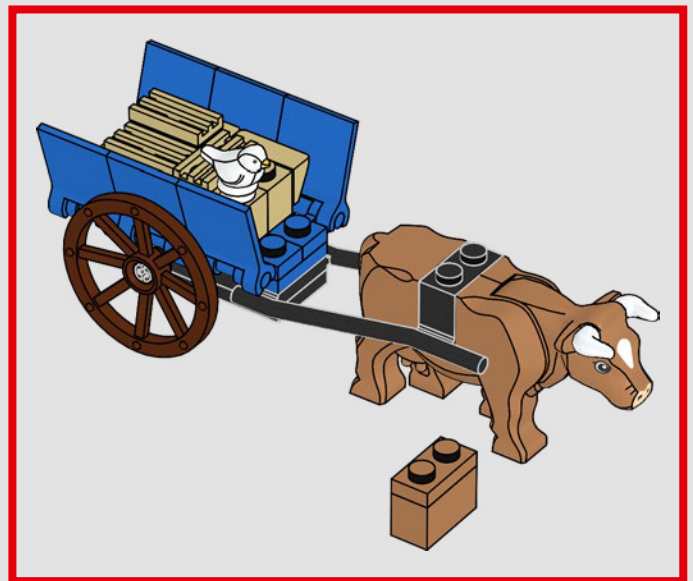
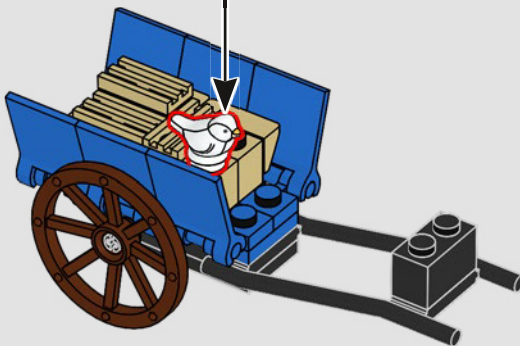

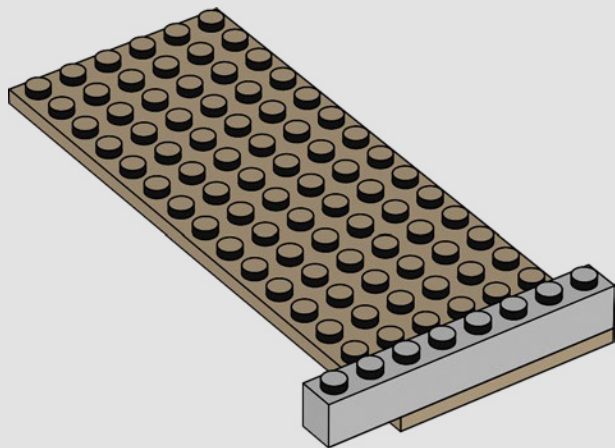
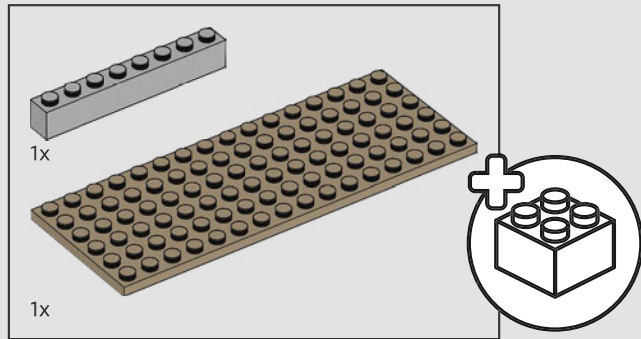
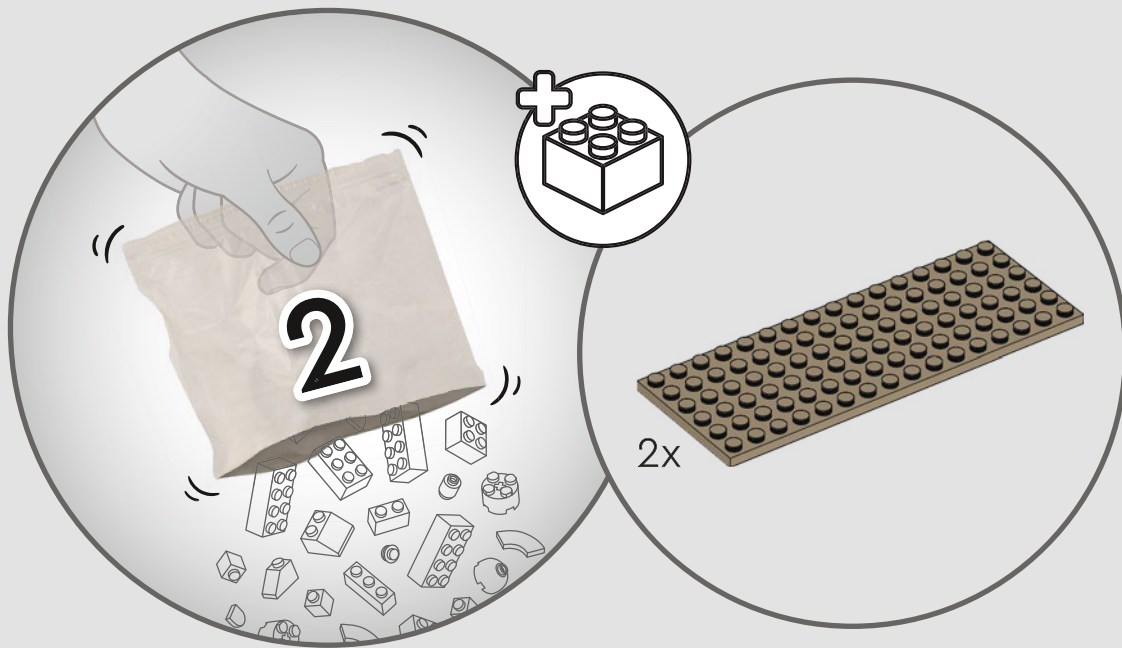

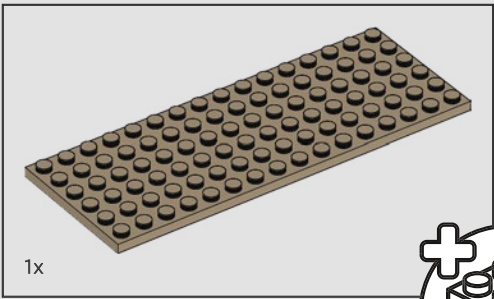

1x

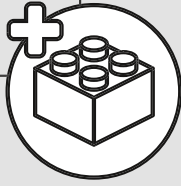

2

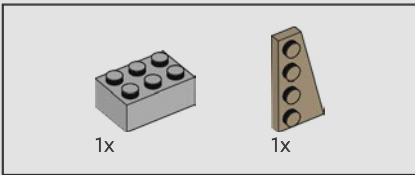
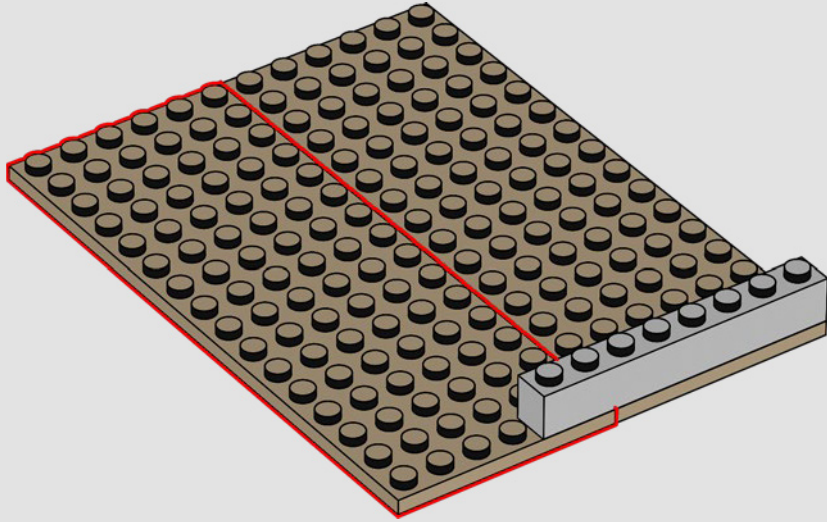

1x

1x

3

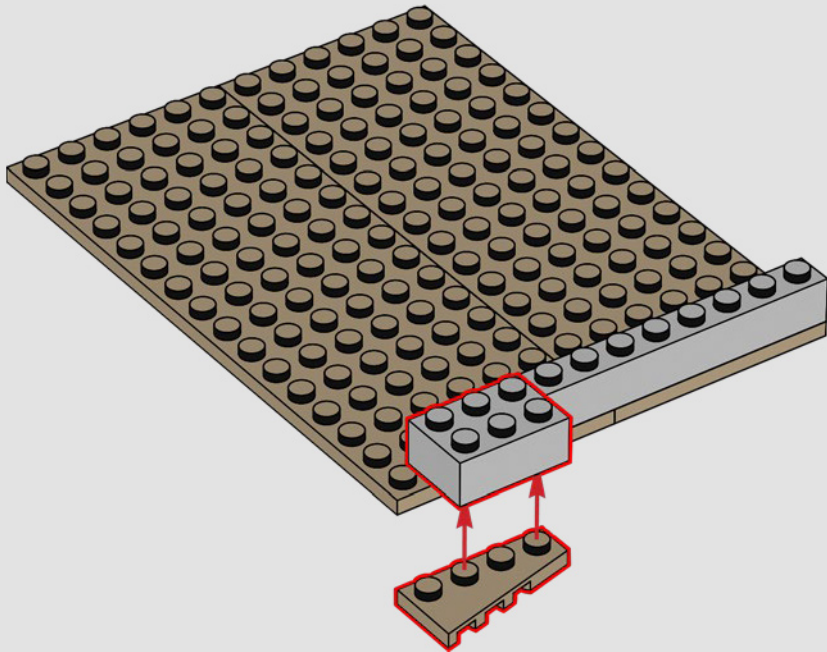

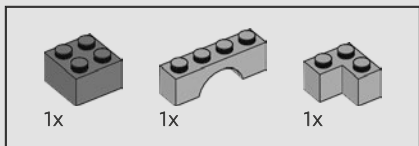

4

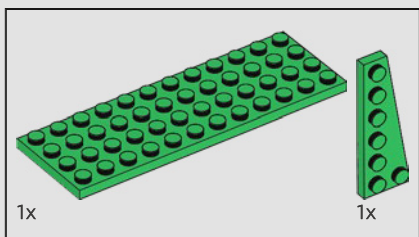
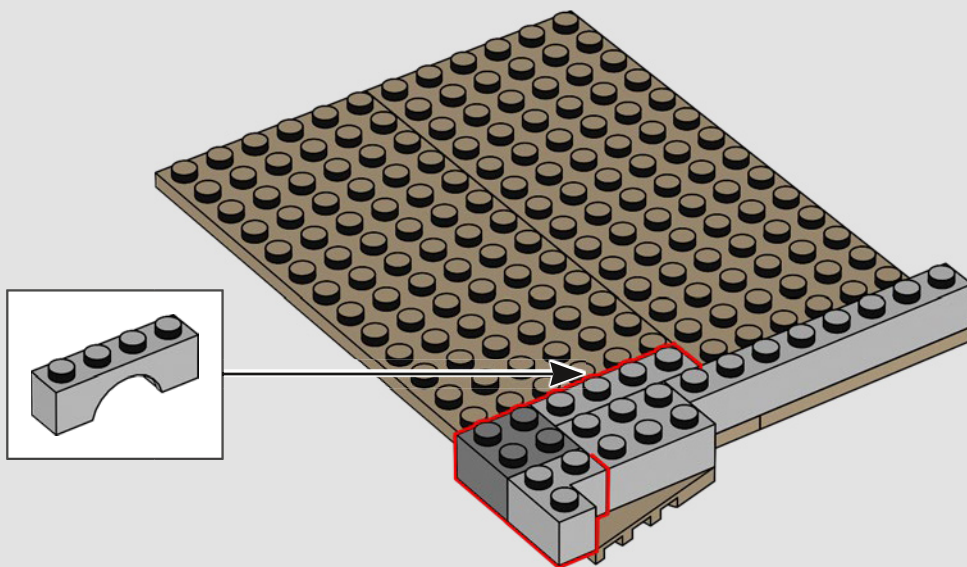

5

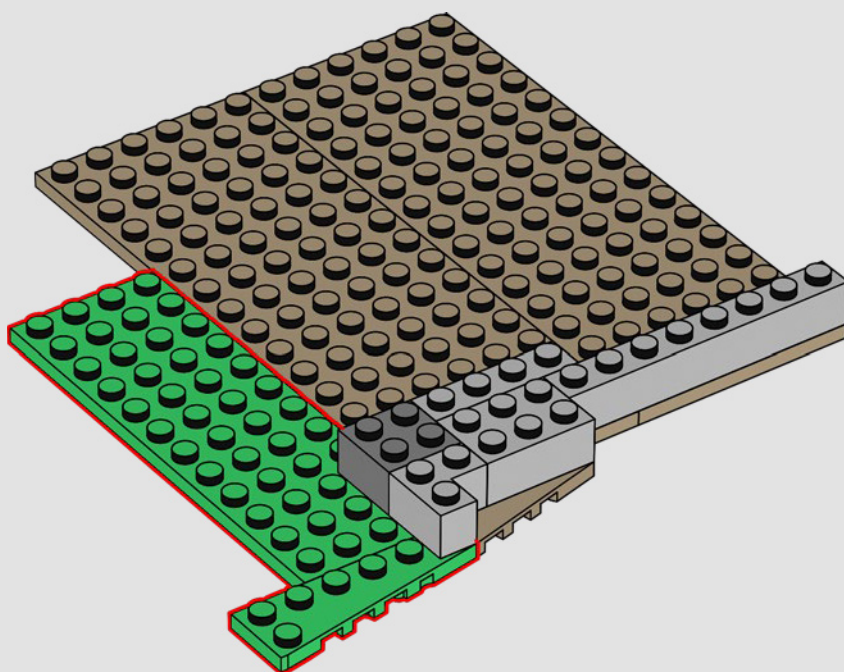

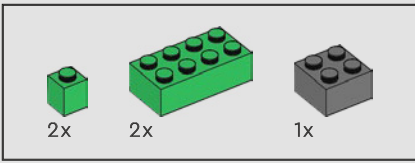

6

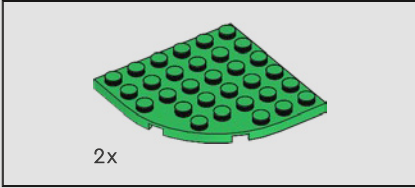
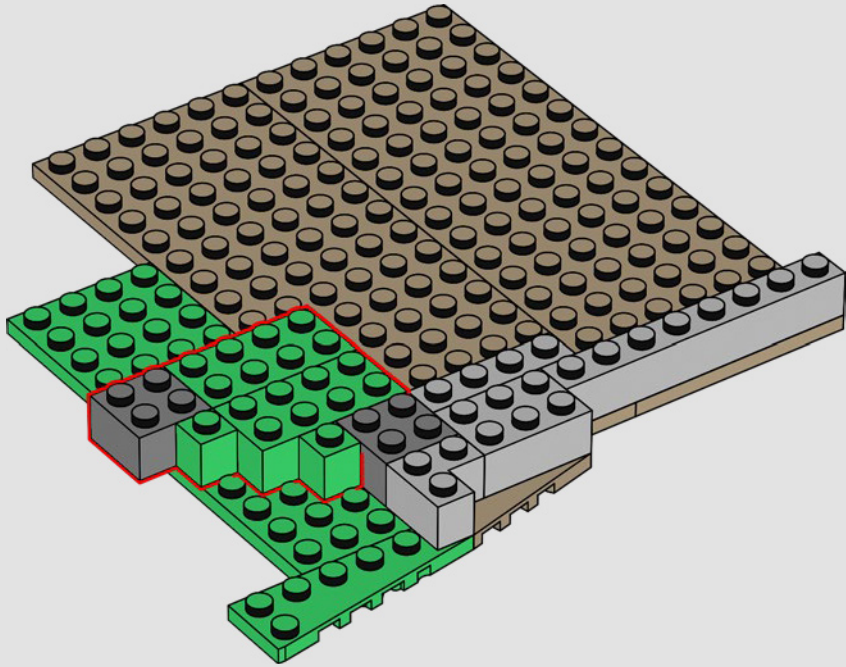

7

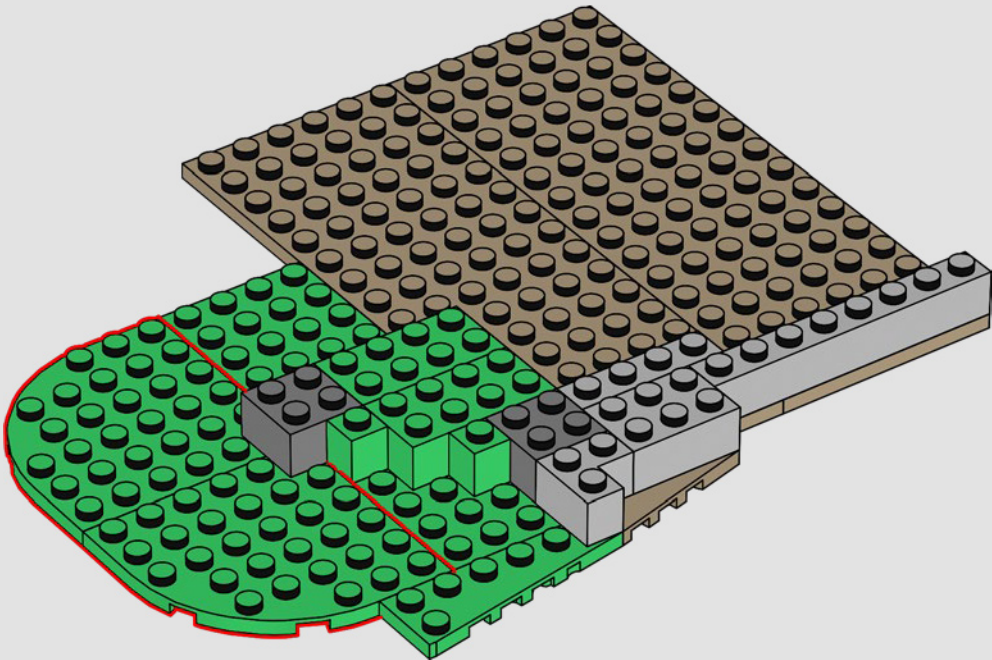

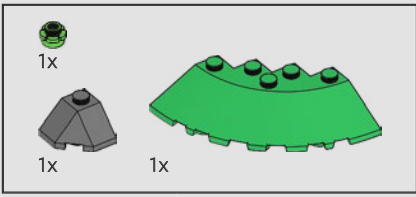

8

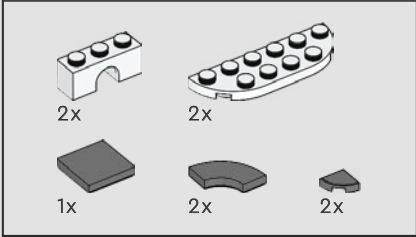
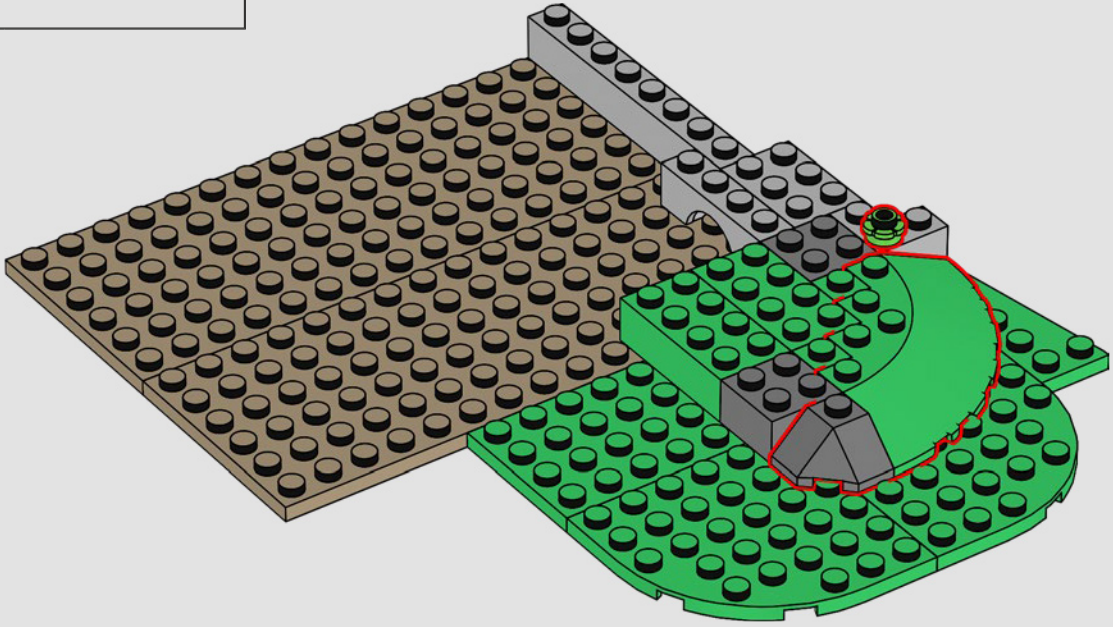

9

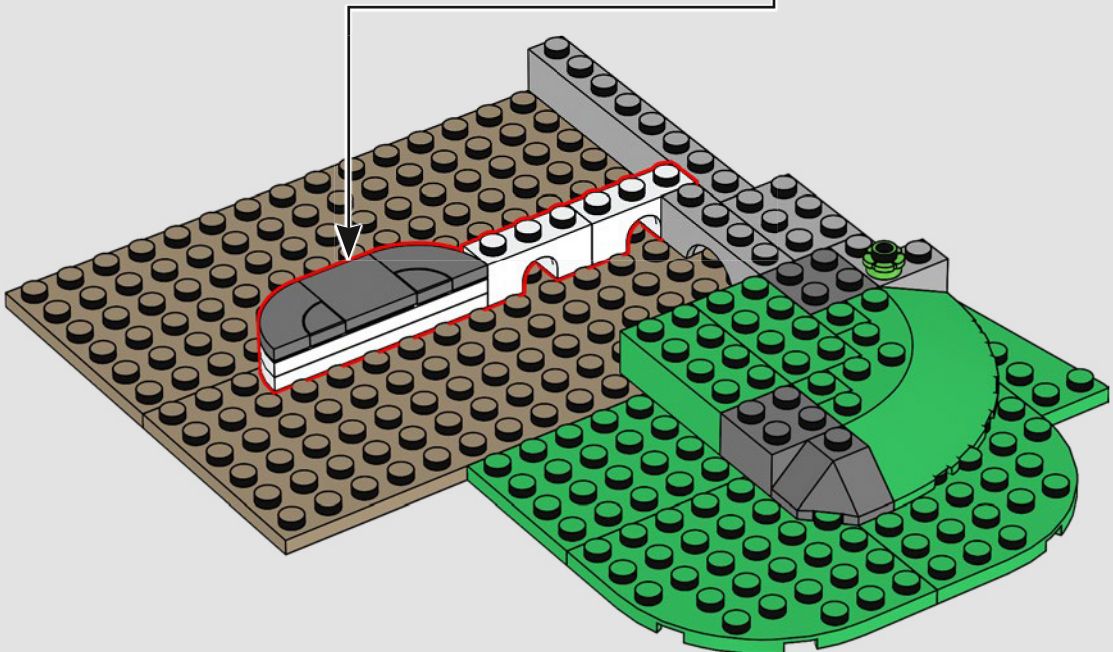
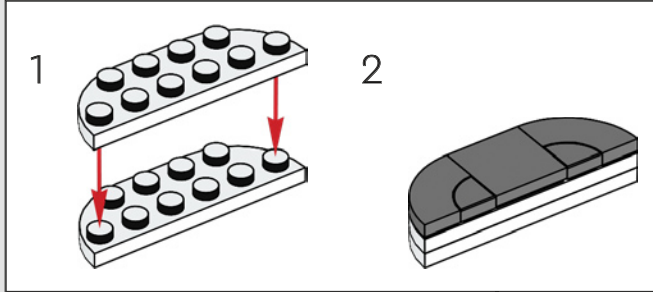

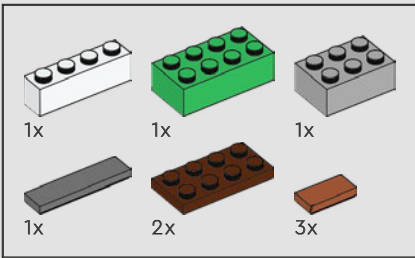

10

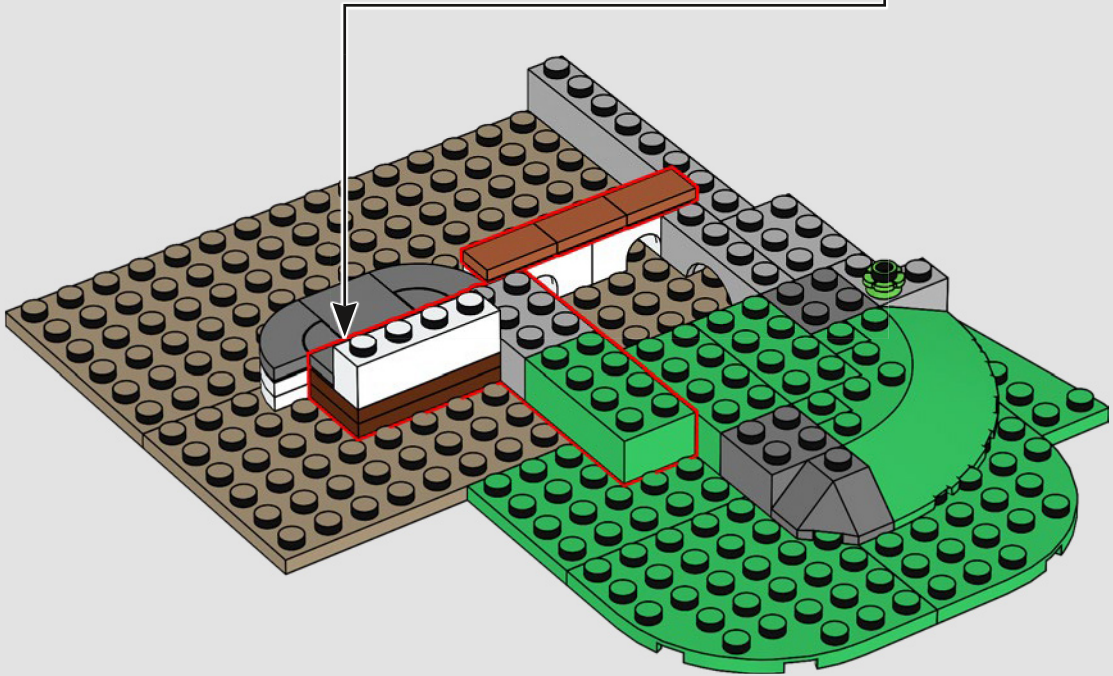
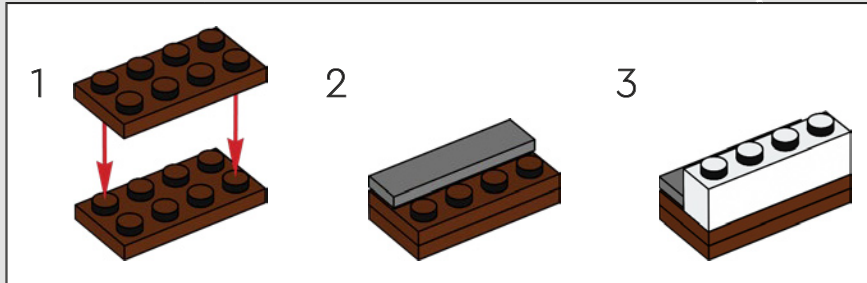

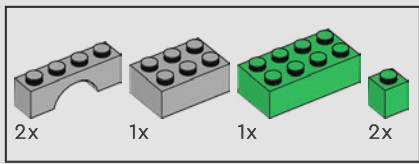

11

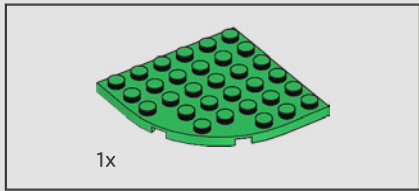
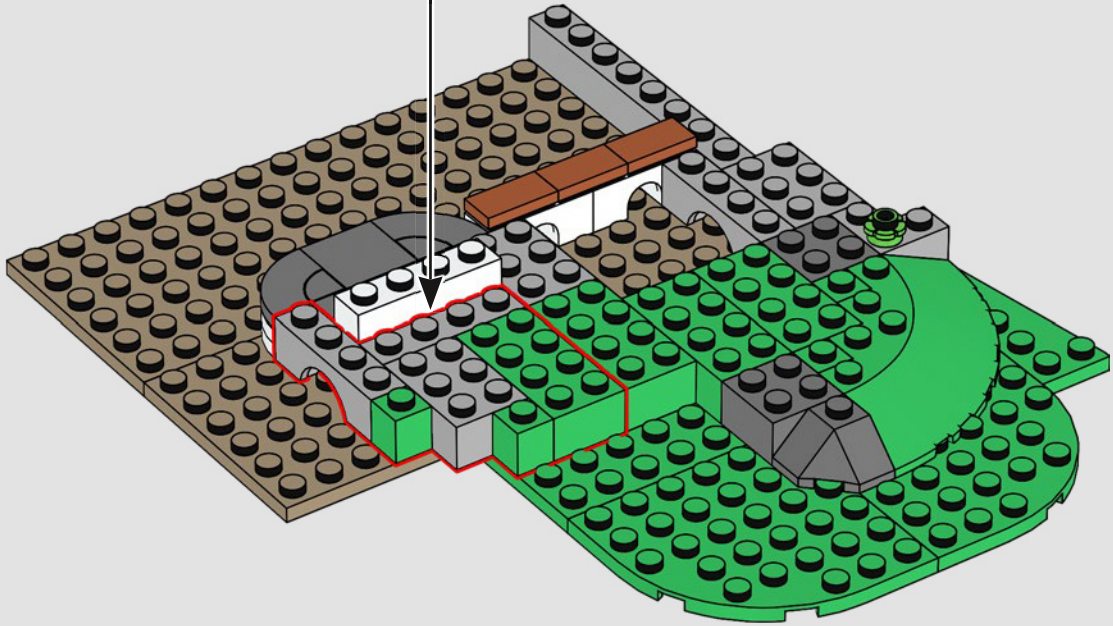
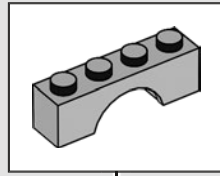

12

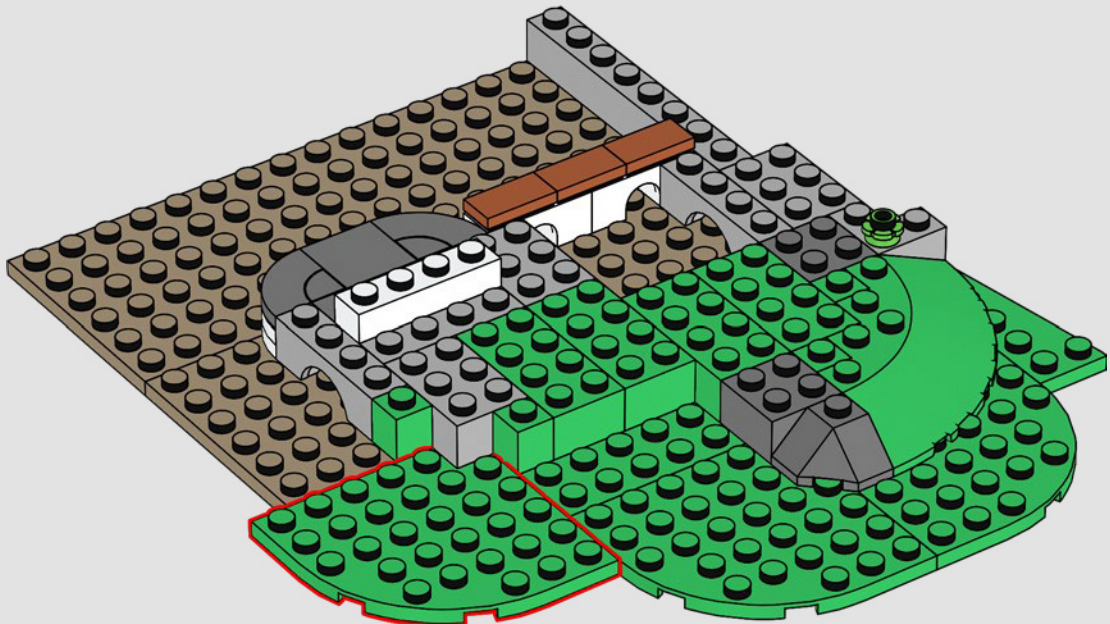

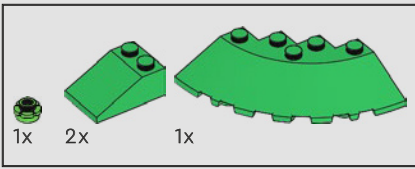

13

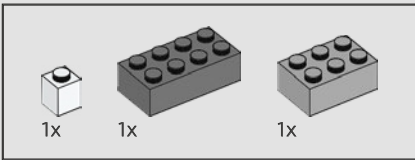
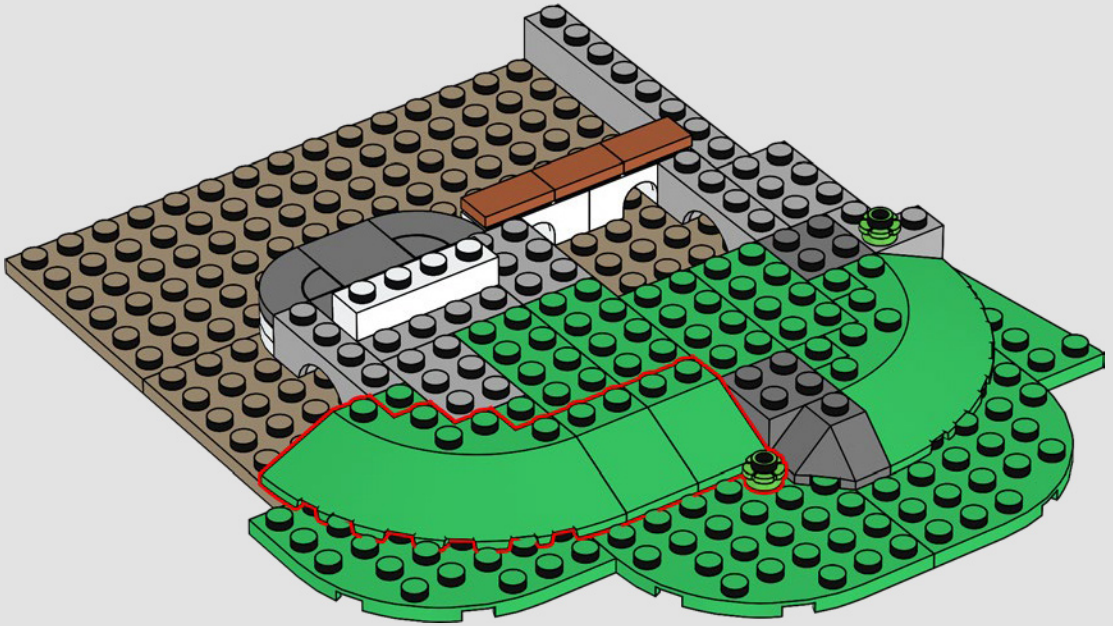

14

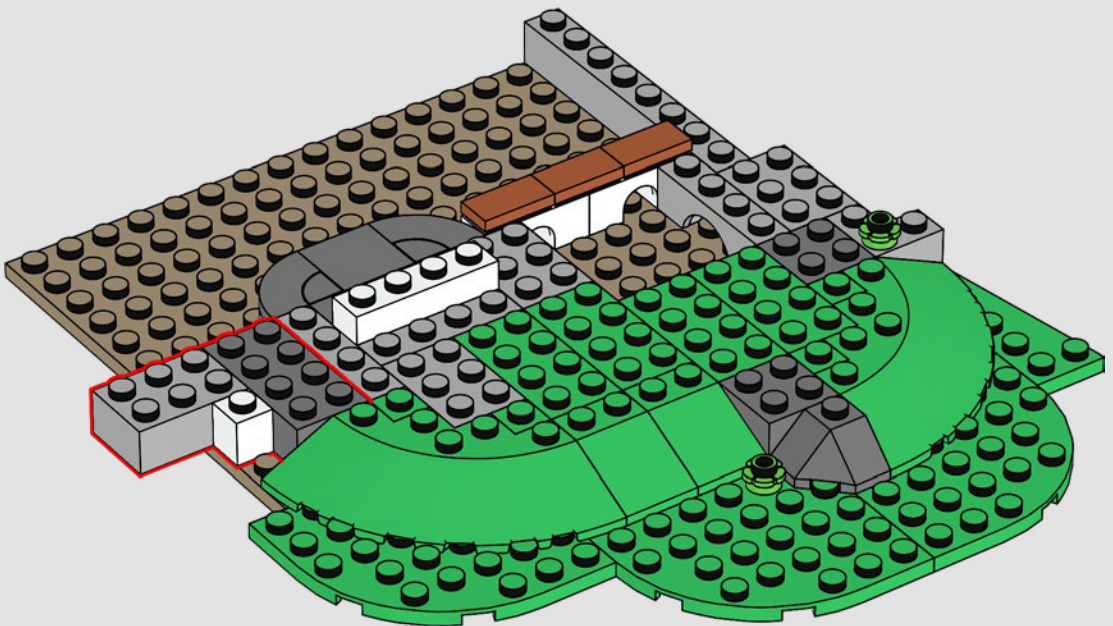

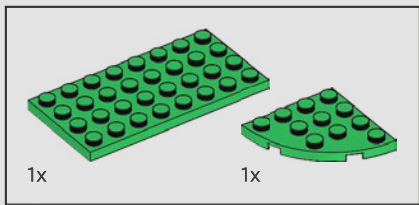

15

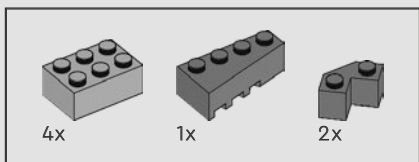
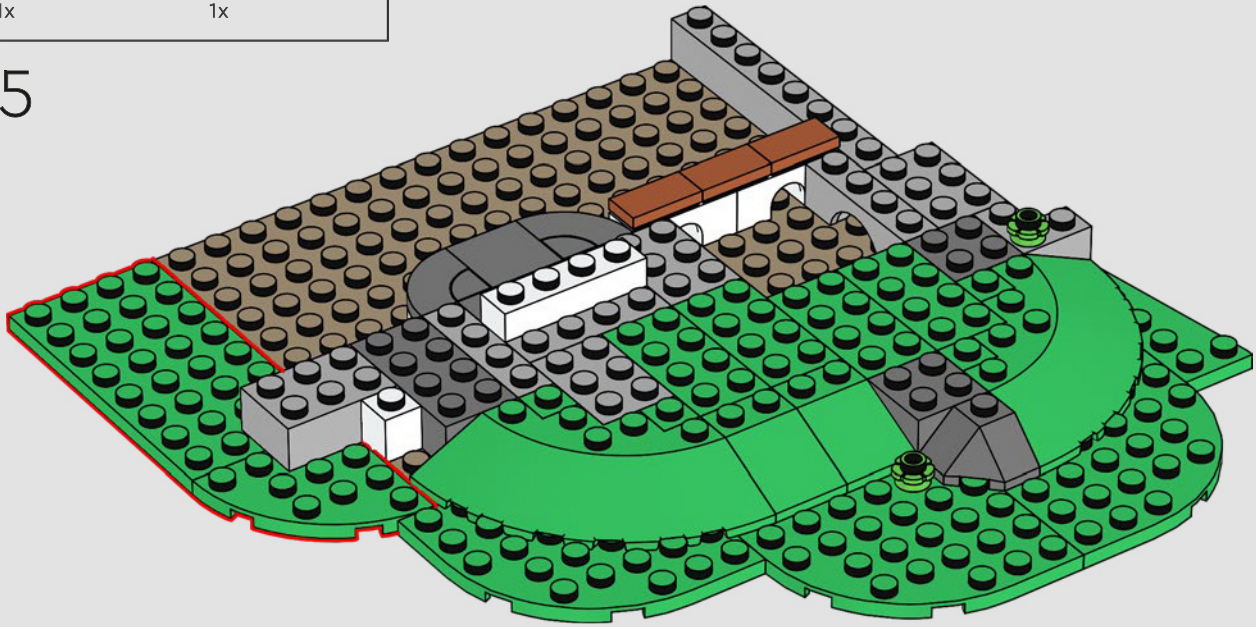

16

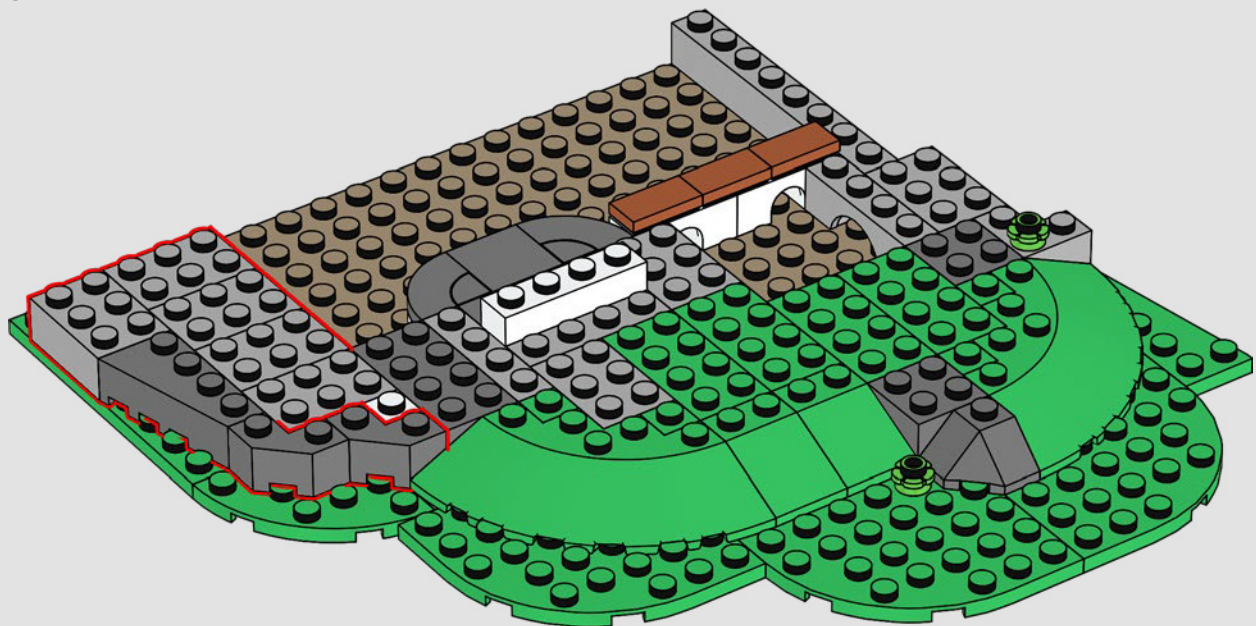

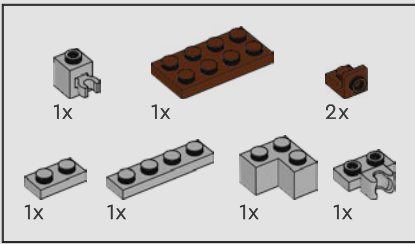

17

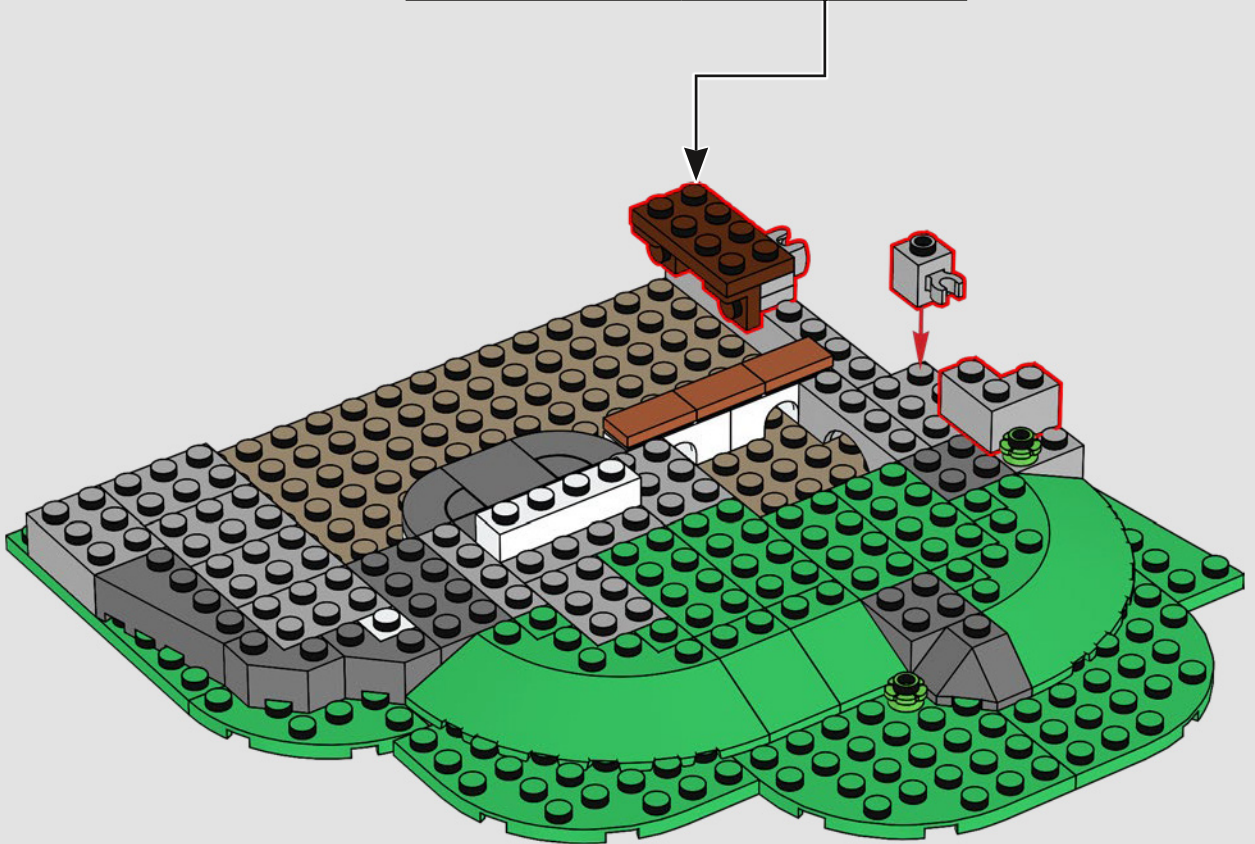
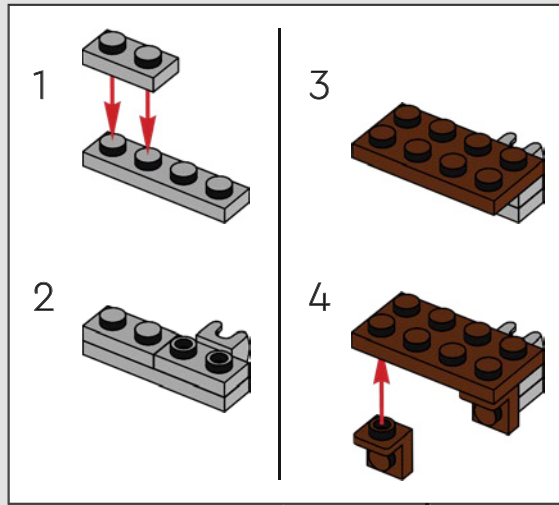

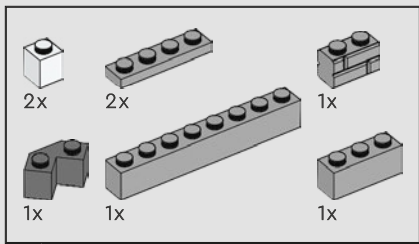

18

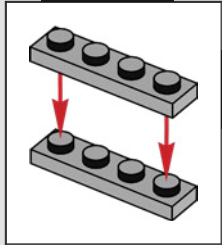
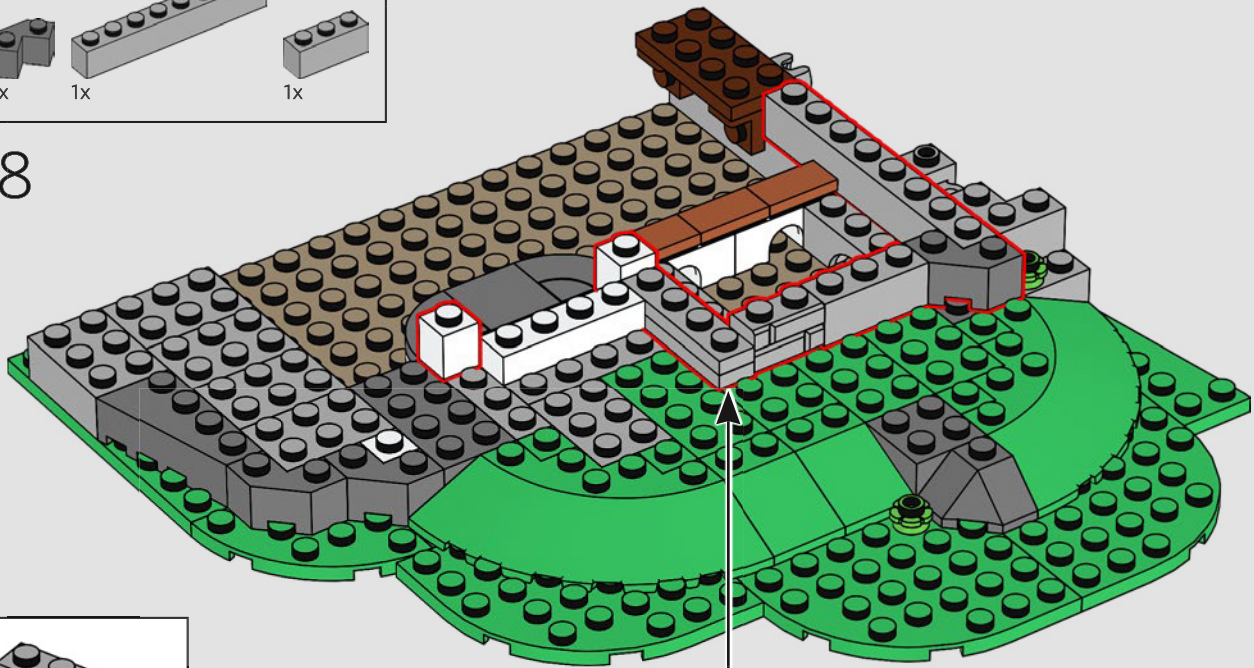

19

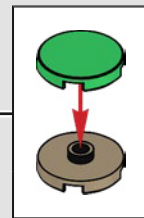
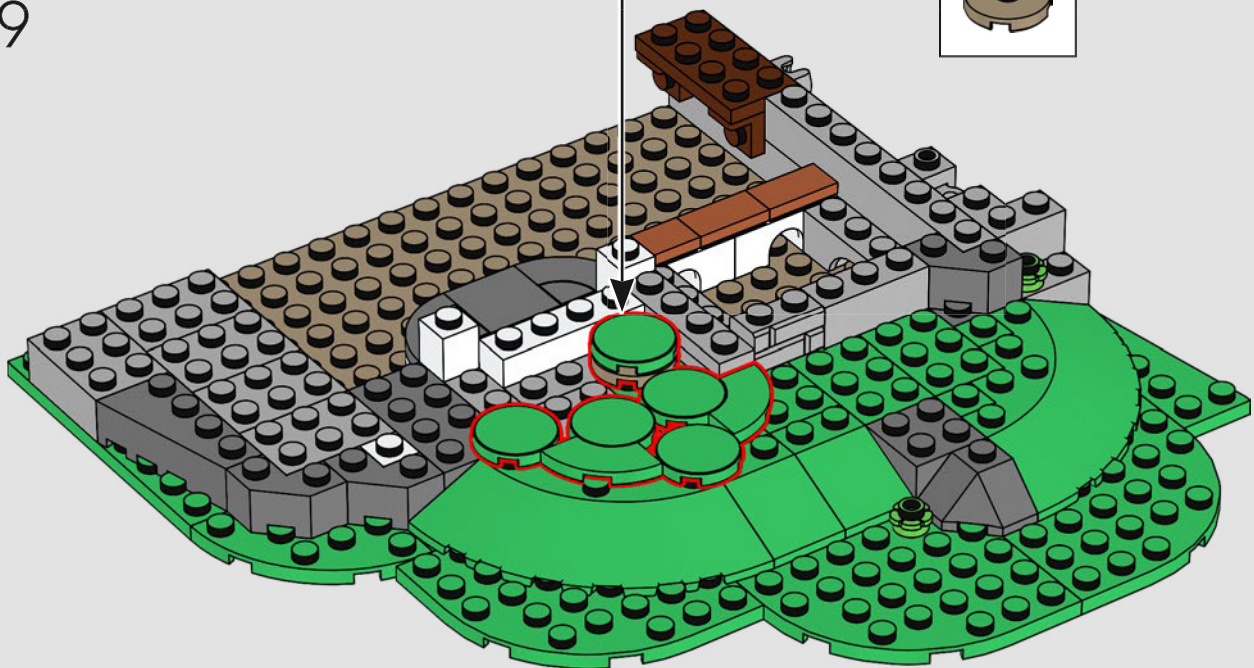

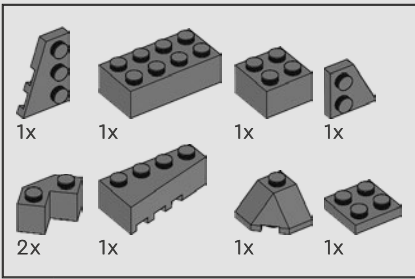

20

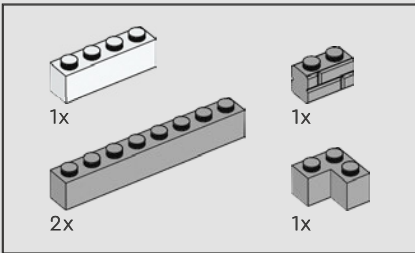
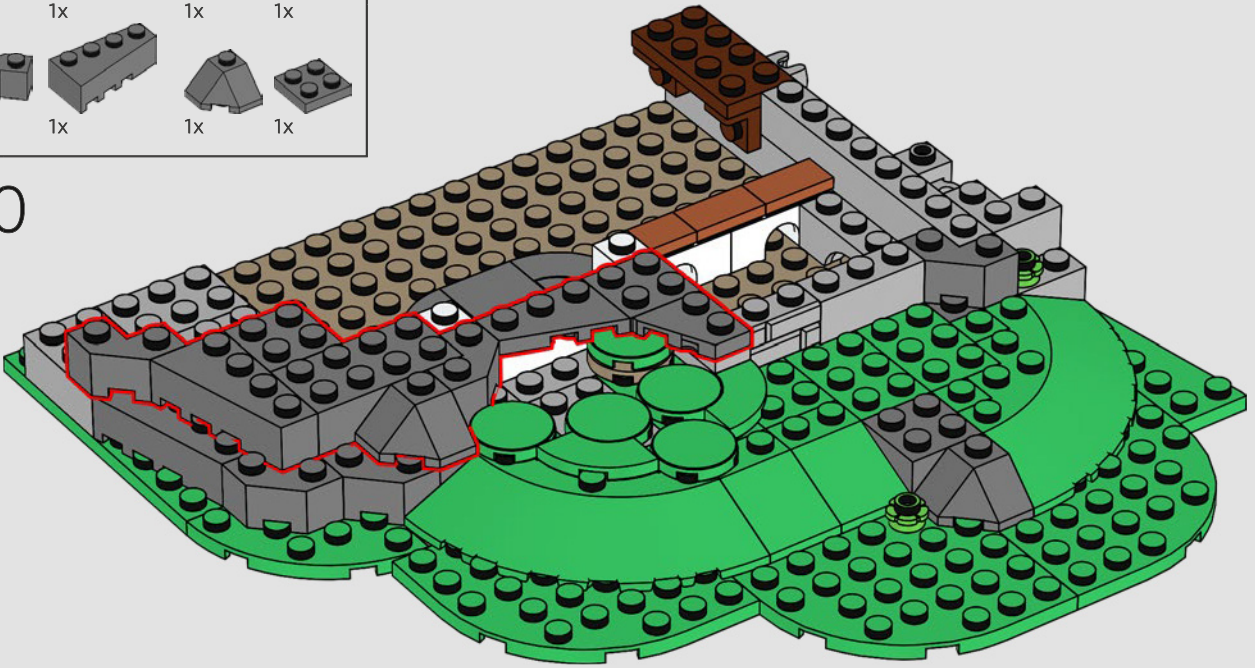

21

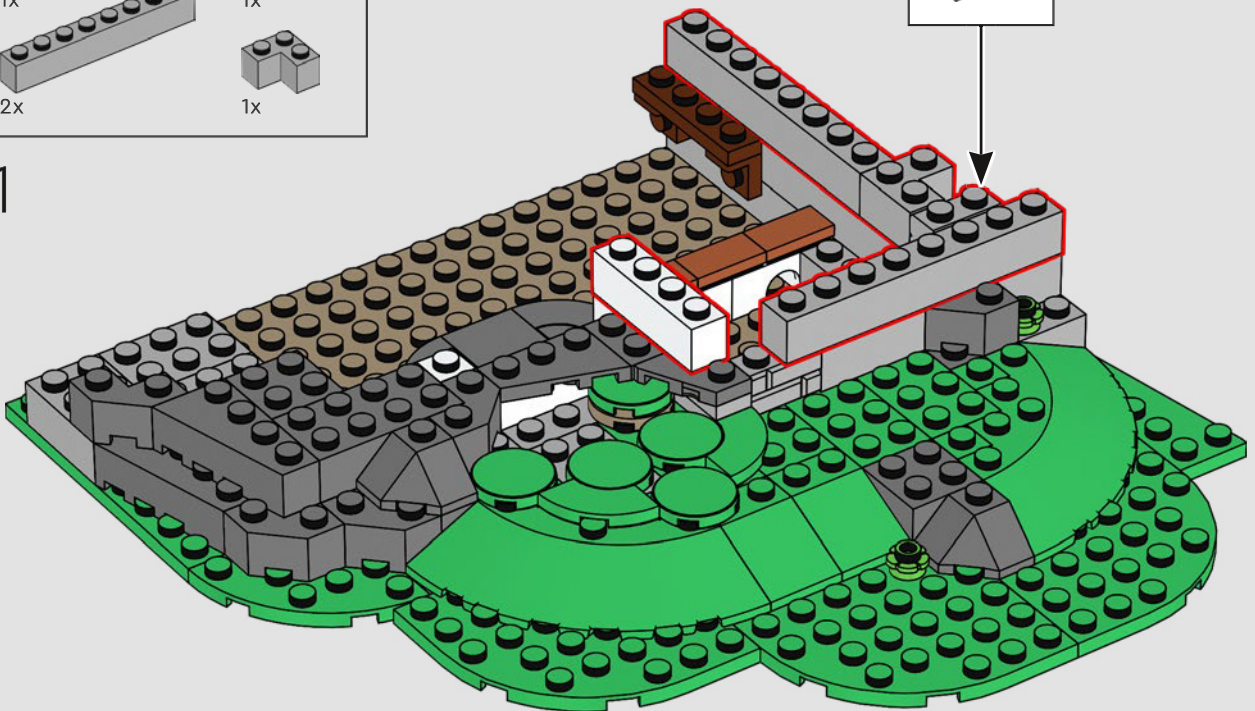
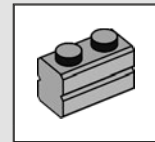

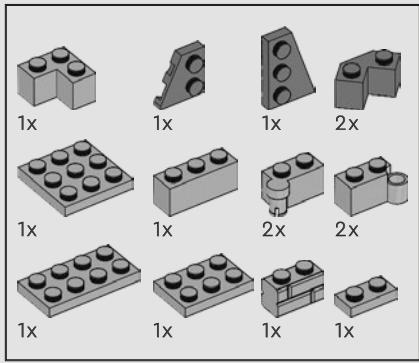

22

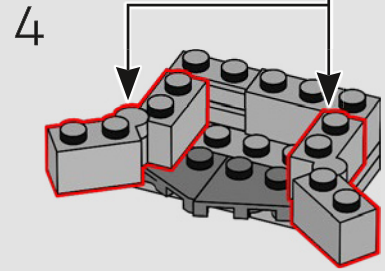
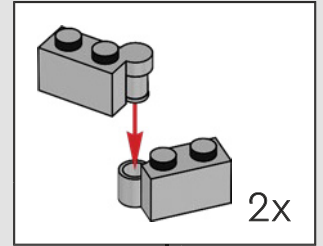
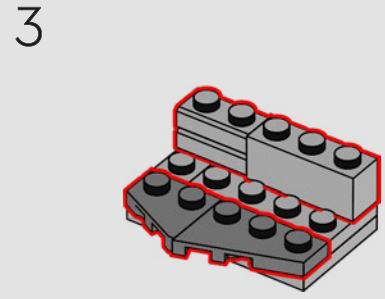
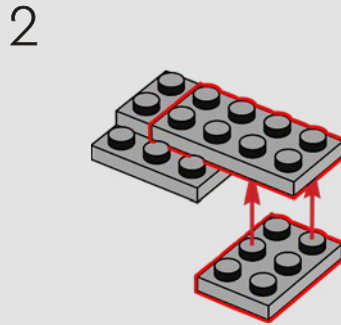
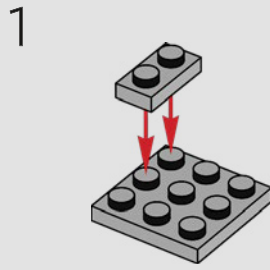

Comment ces murs se raccordent-ils ?
C'est de la magie !

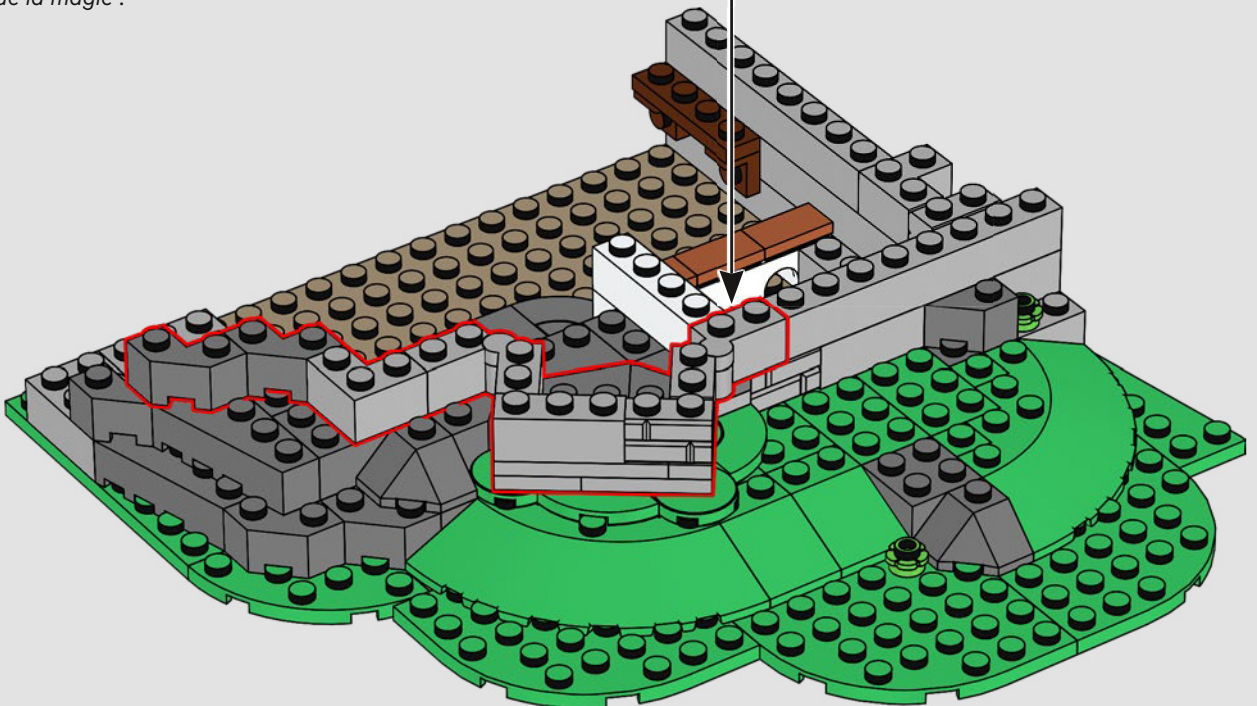

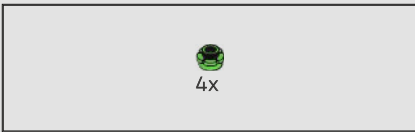

23

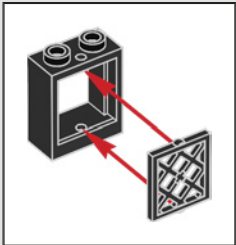
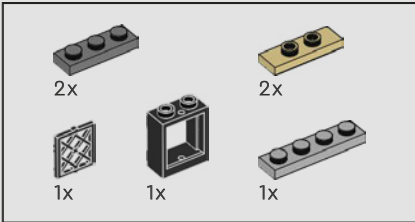
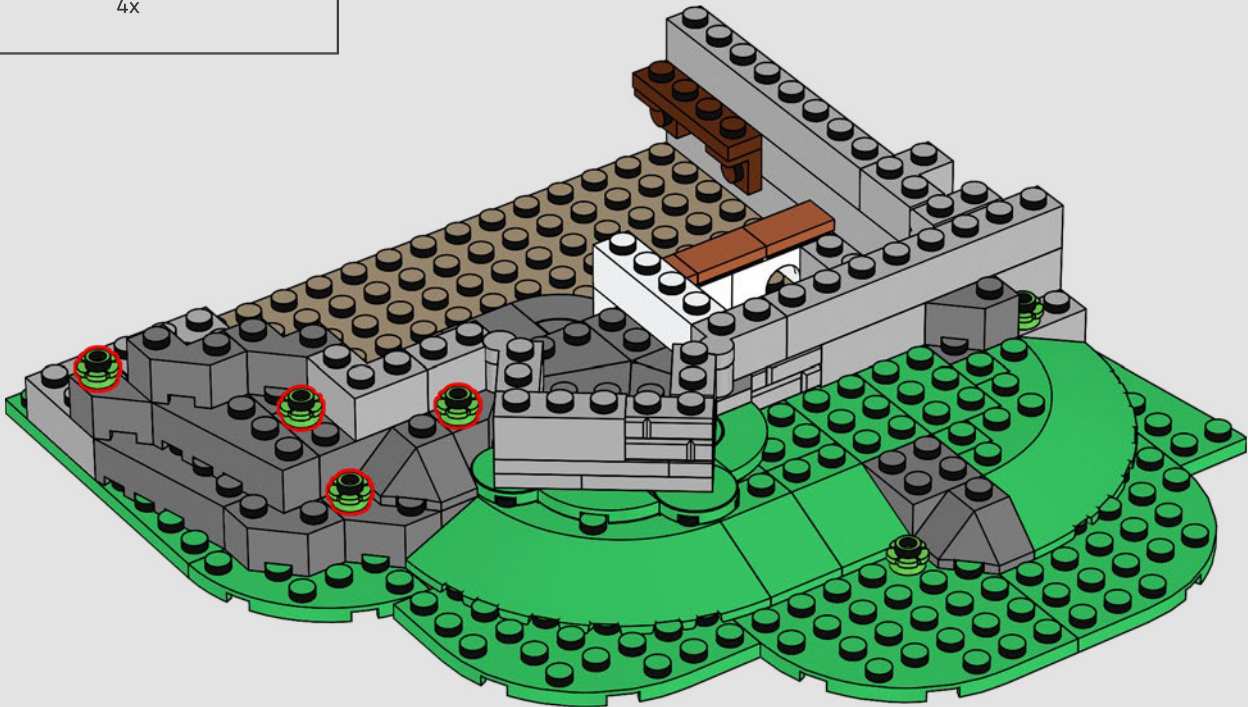

24

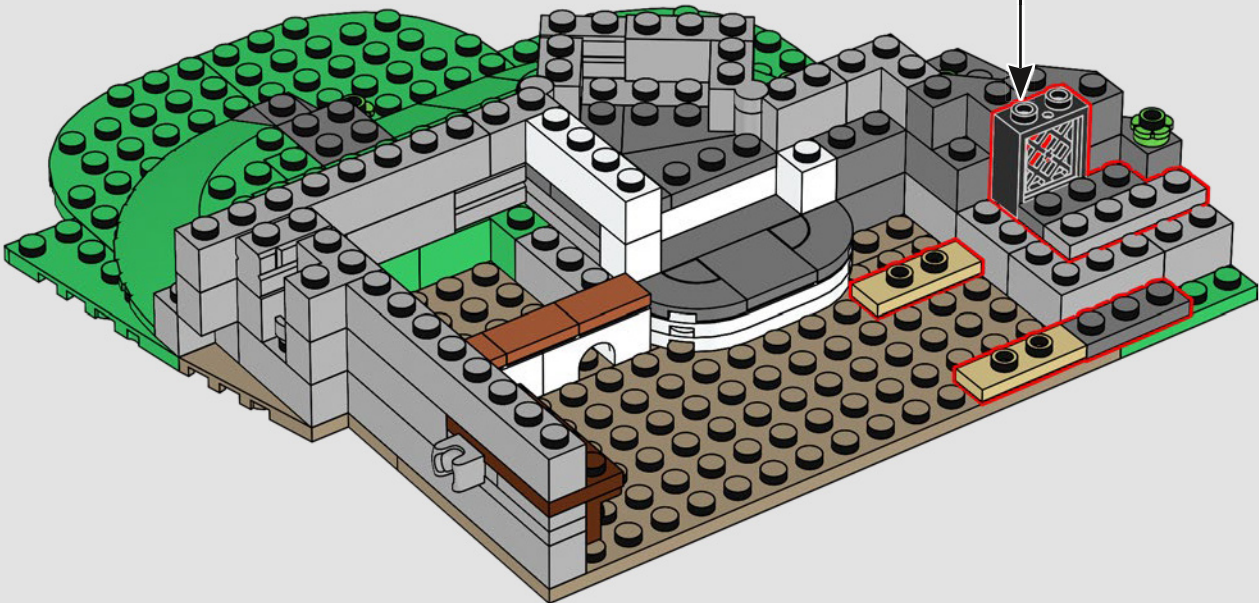

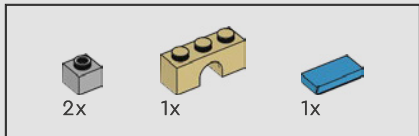

On dirait que quelqu'un s'est assis sur une brique 1x1 ! Ou est-ce plutôt une assiette étirée ?

25

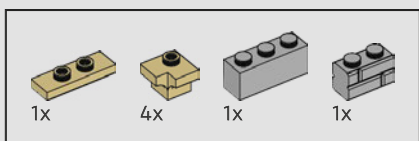
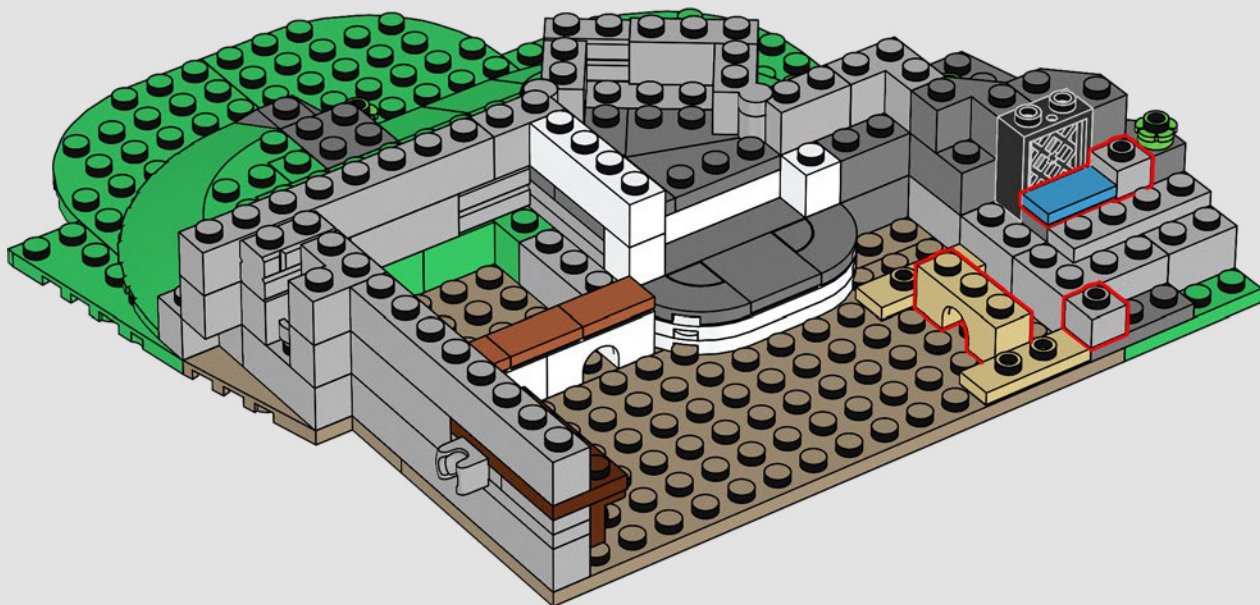

26

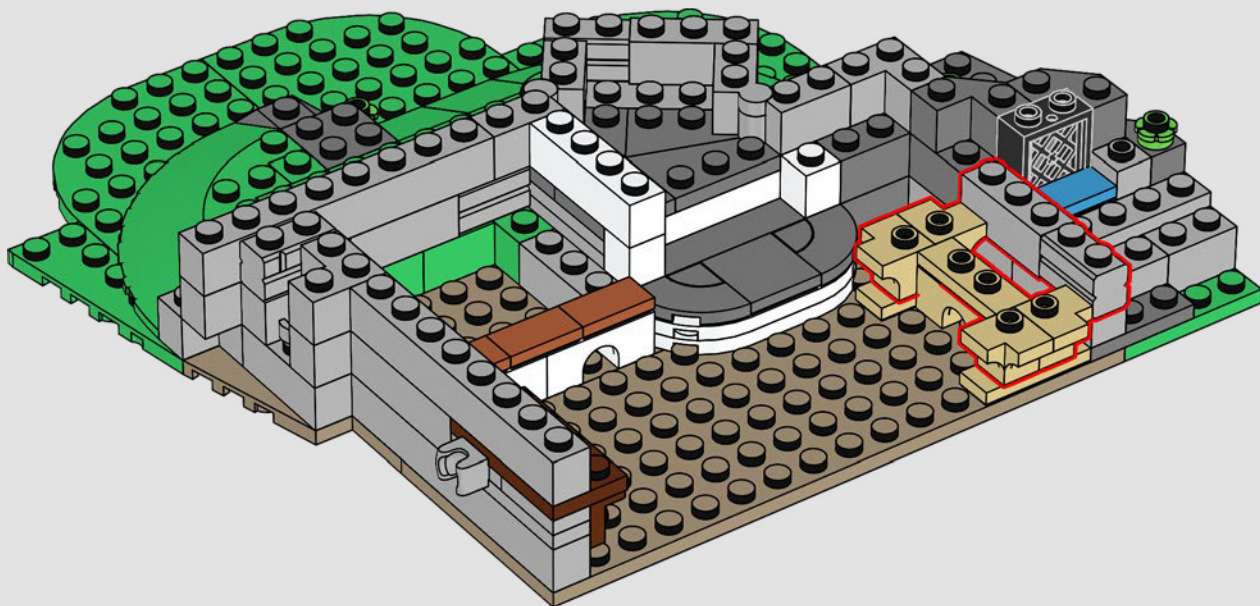

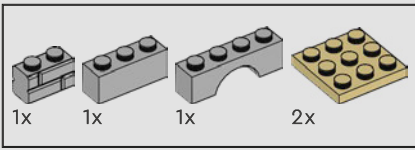

27

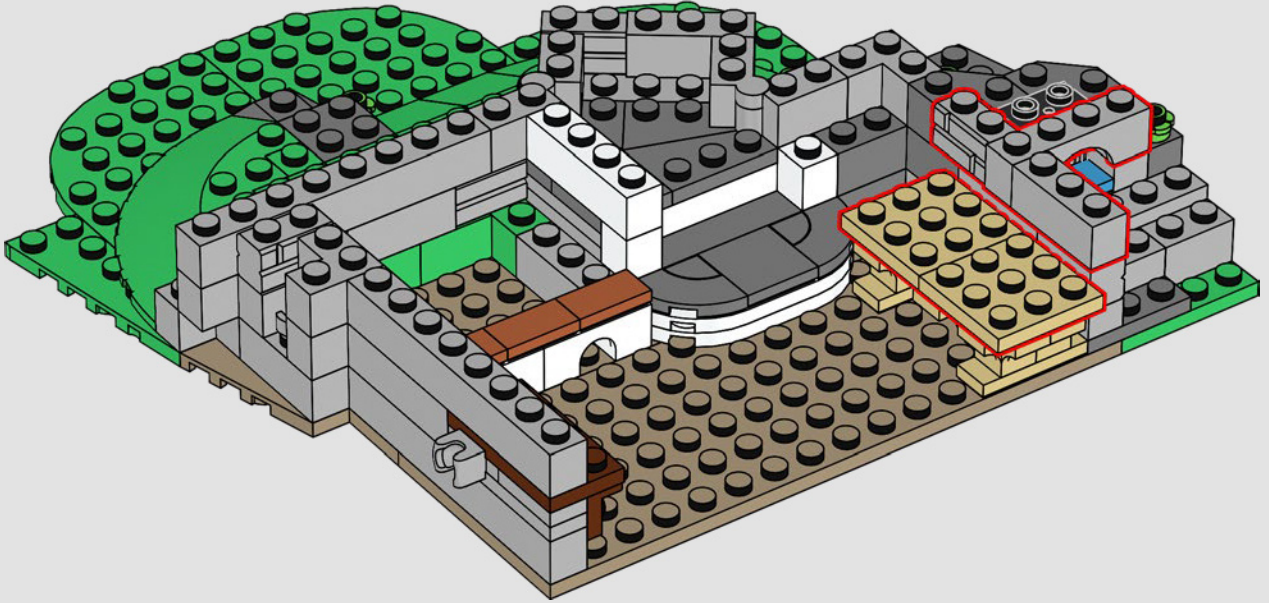

28

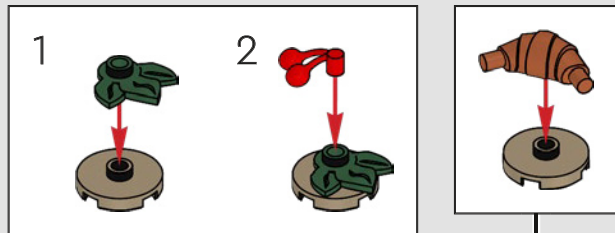

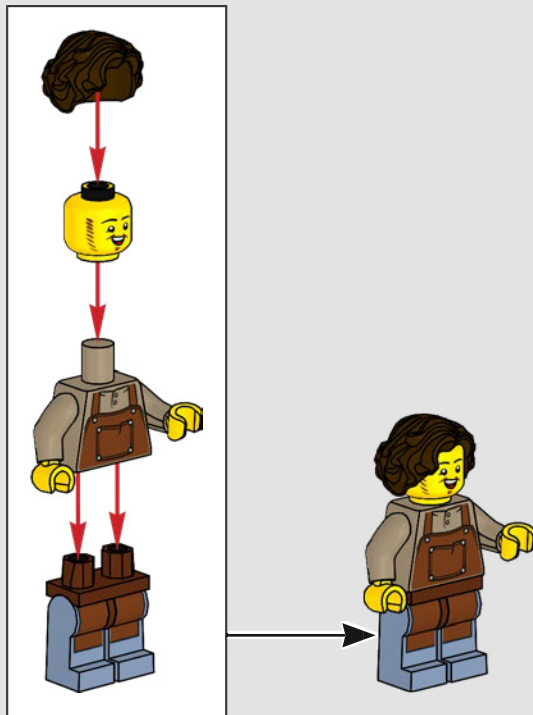



Qu'est-ce que cette bougie étrangement positionnée illumine ?

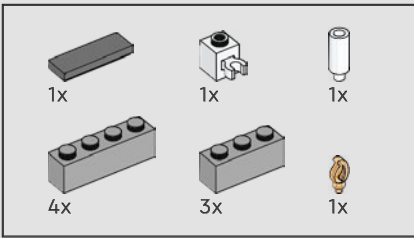

29

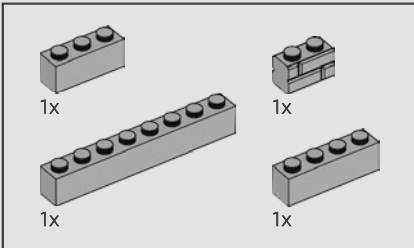
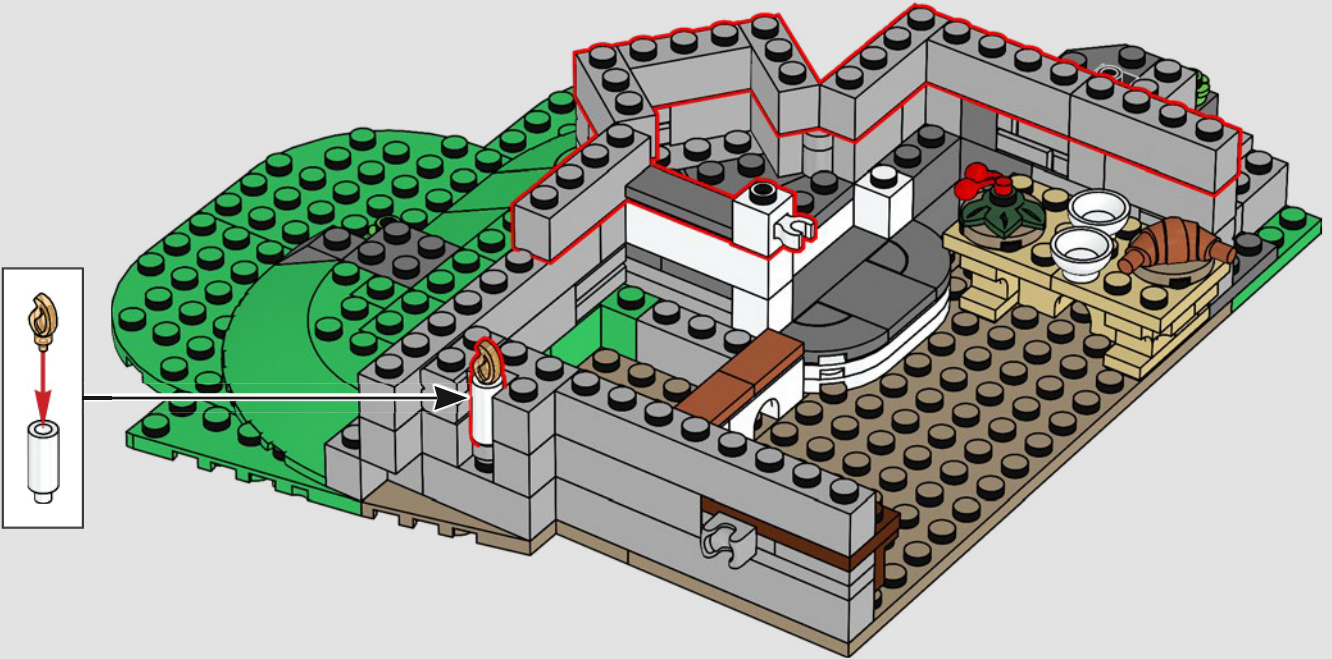

30

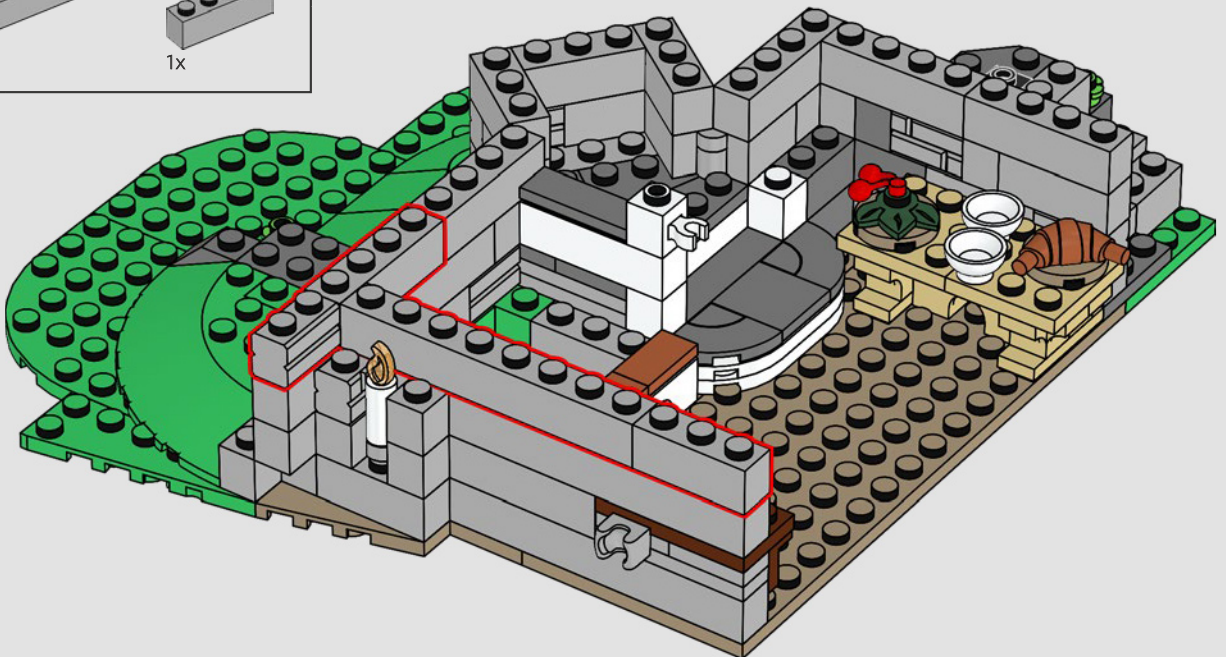

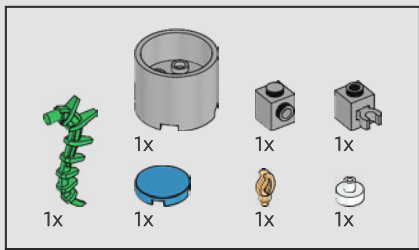

31

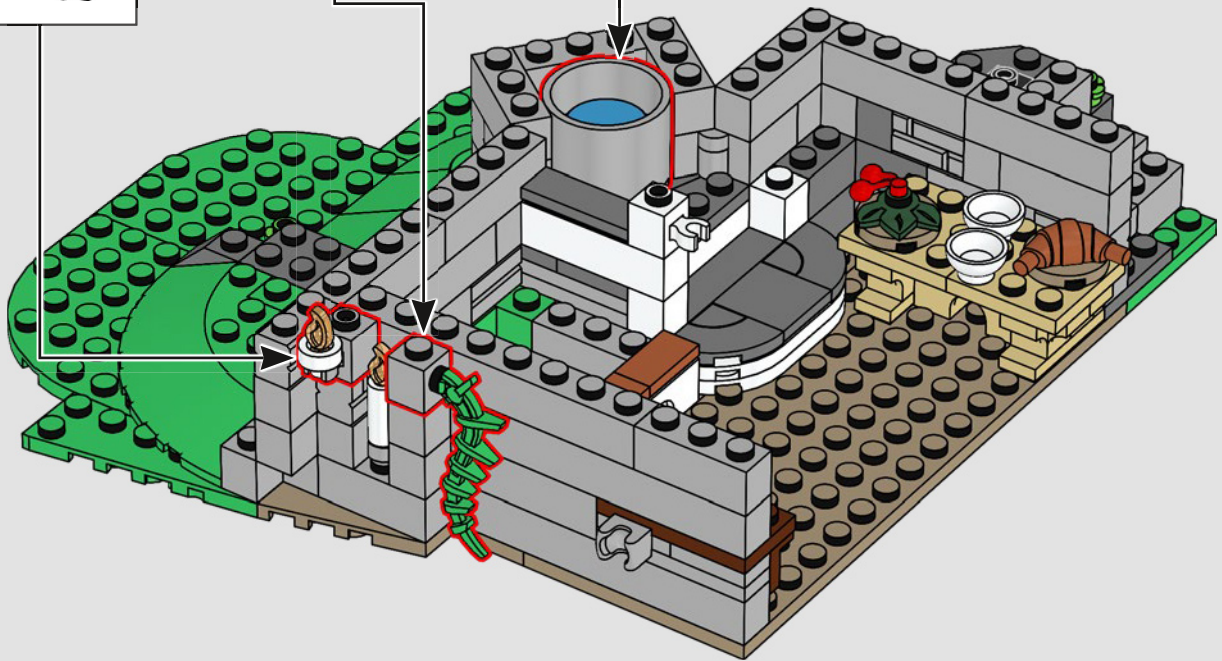
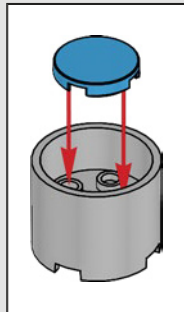
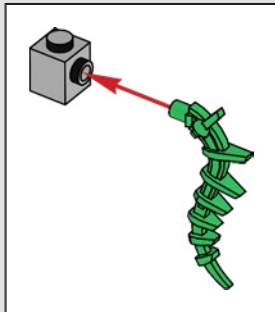
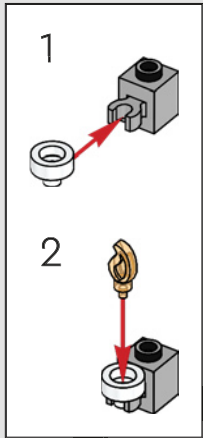

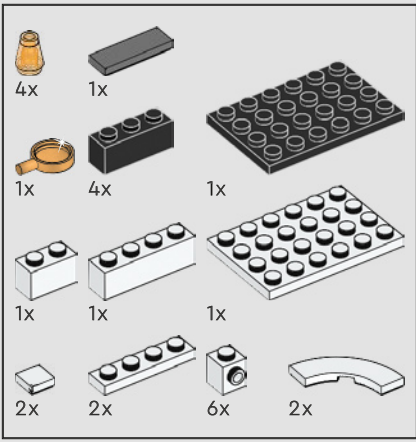

33

1

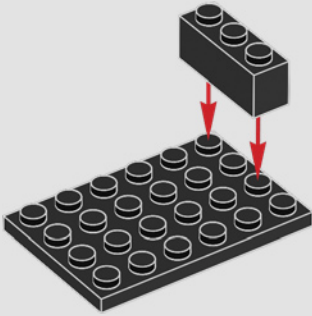

2

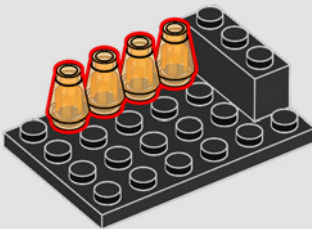

3

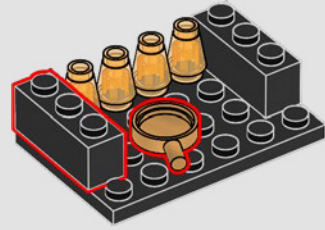

4

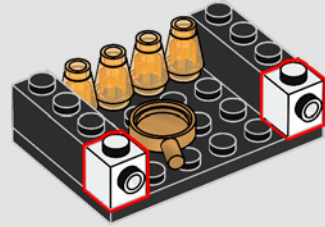

5

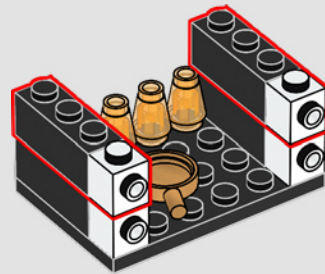

6

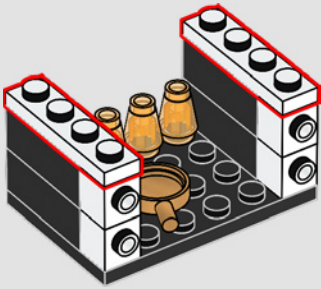

8

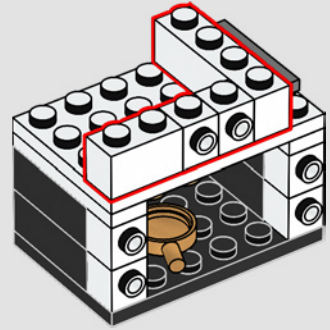

7

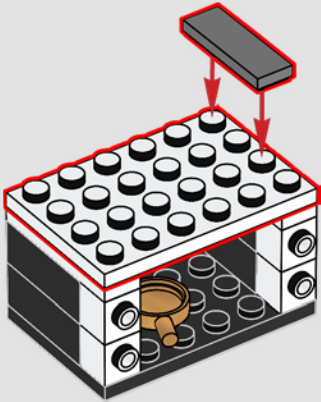

9

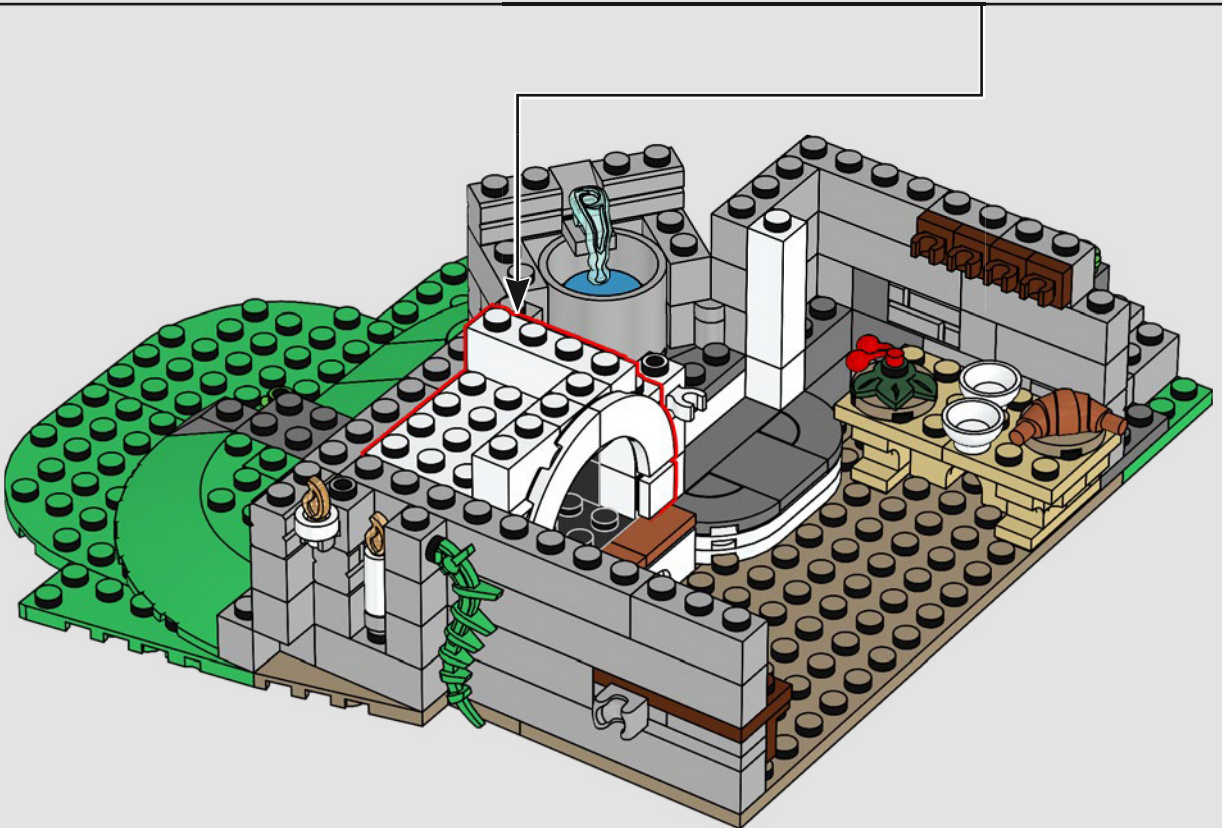
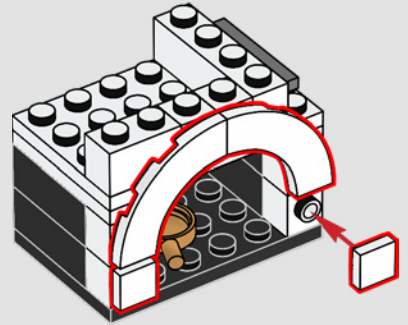

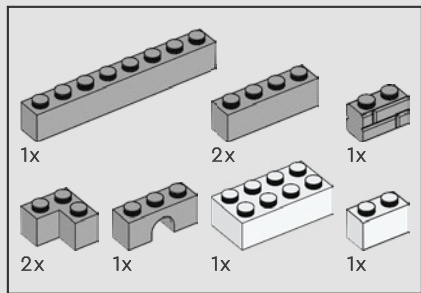

34

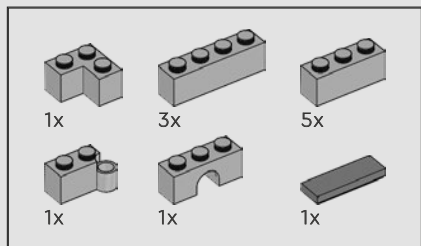
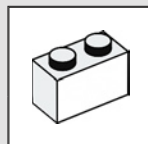
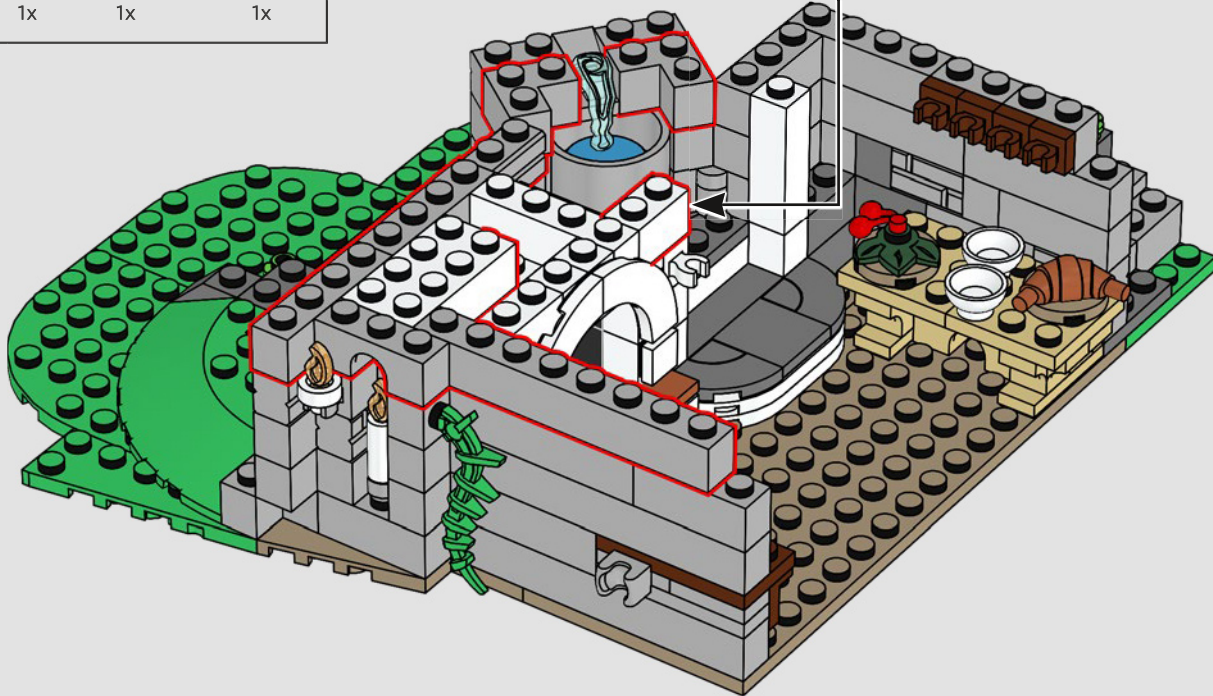

35

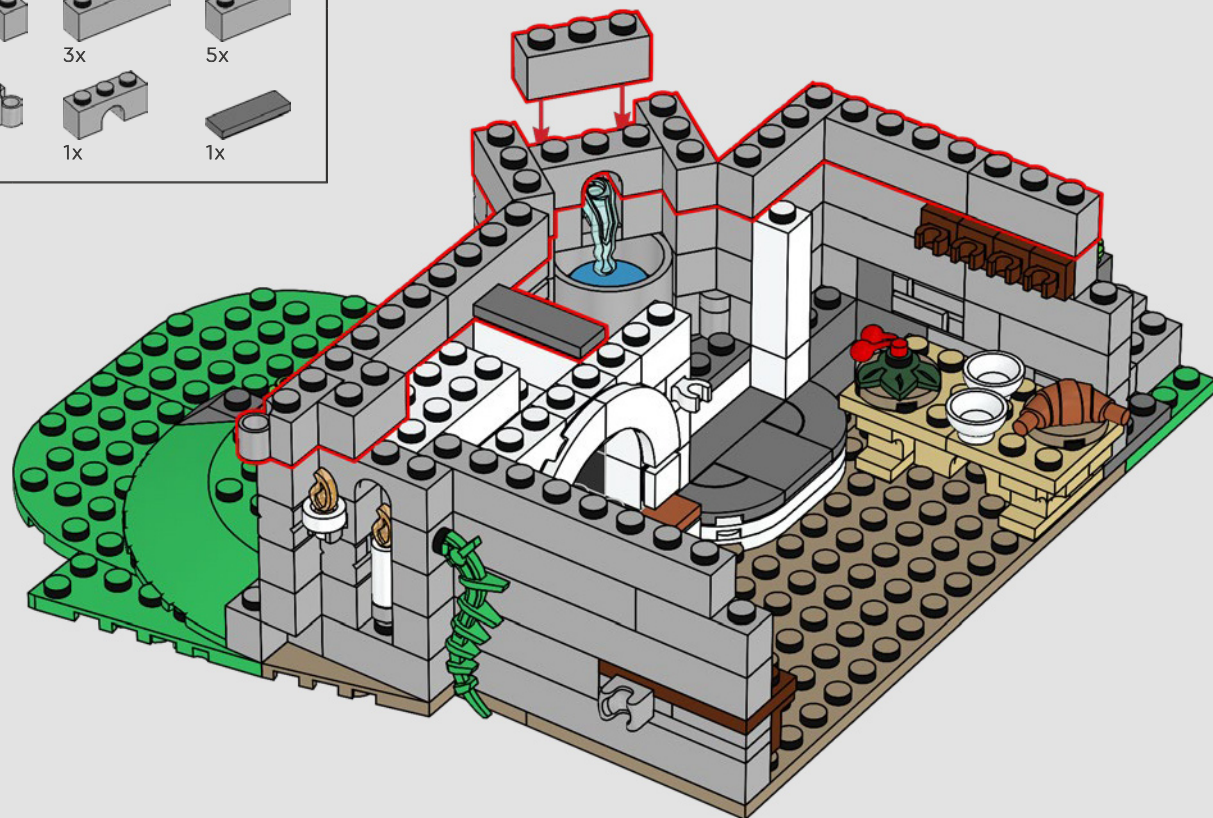

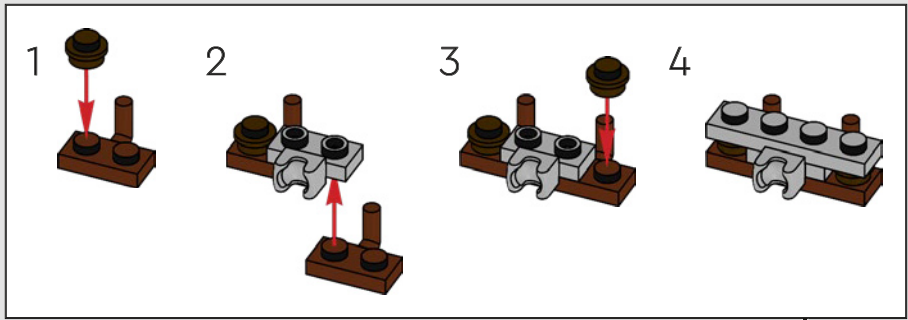
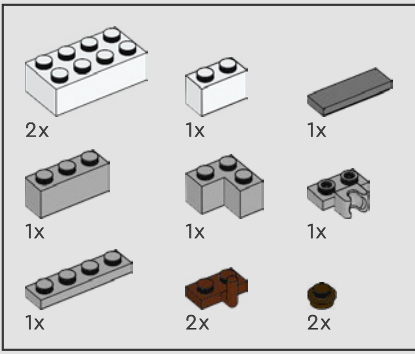

36

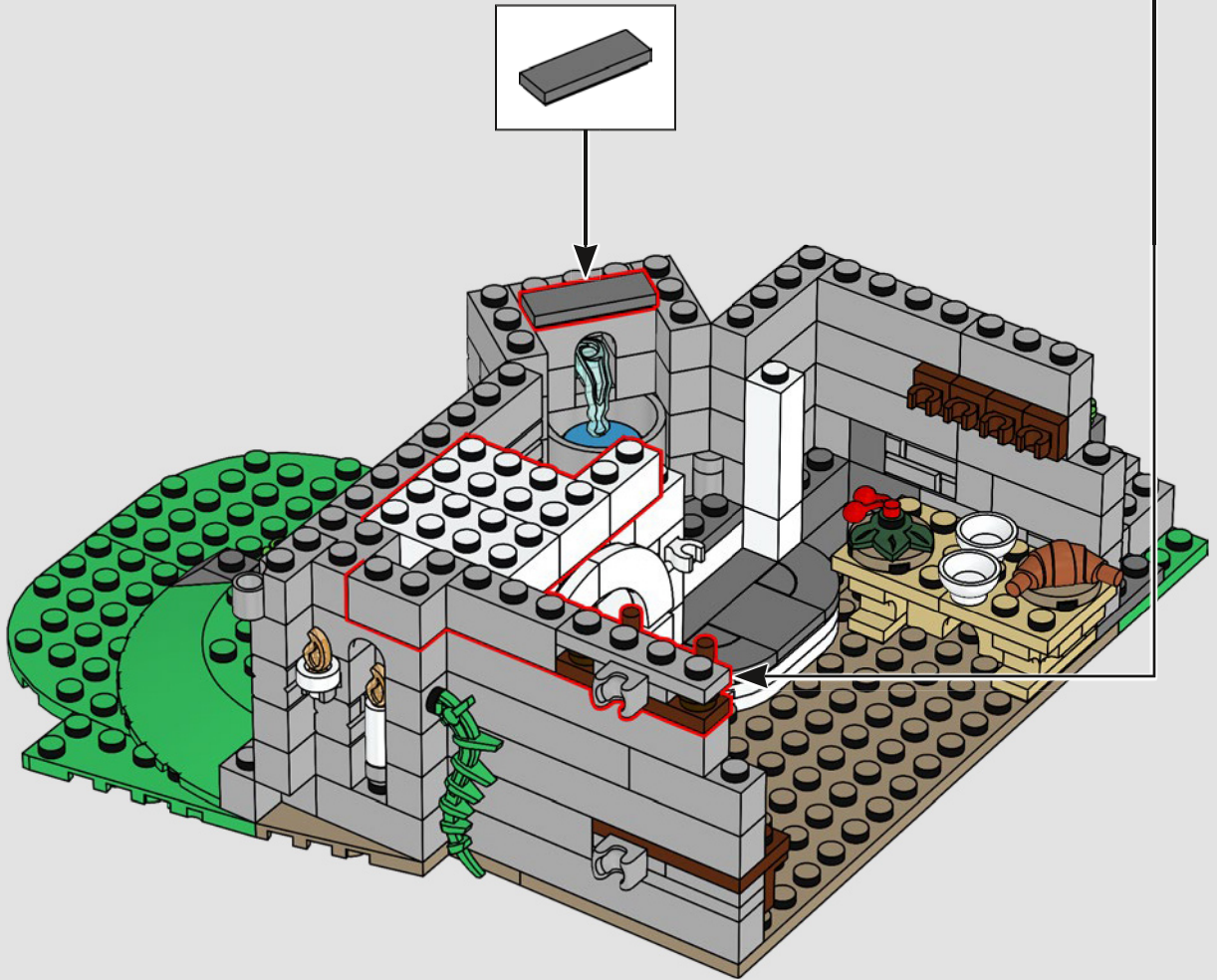

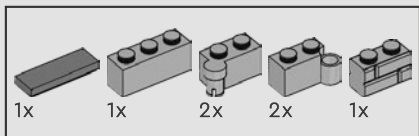

37

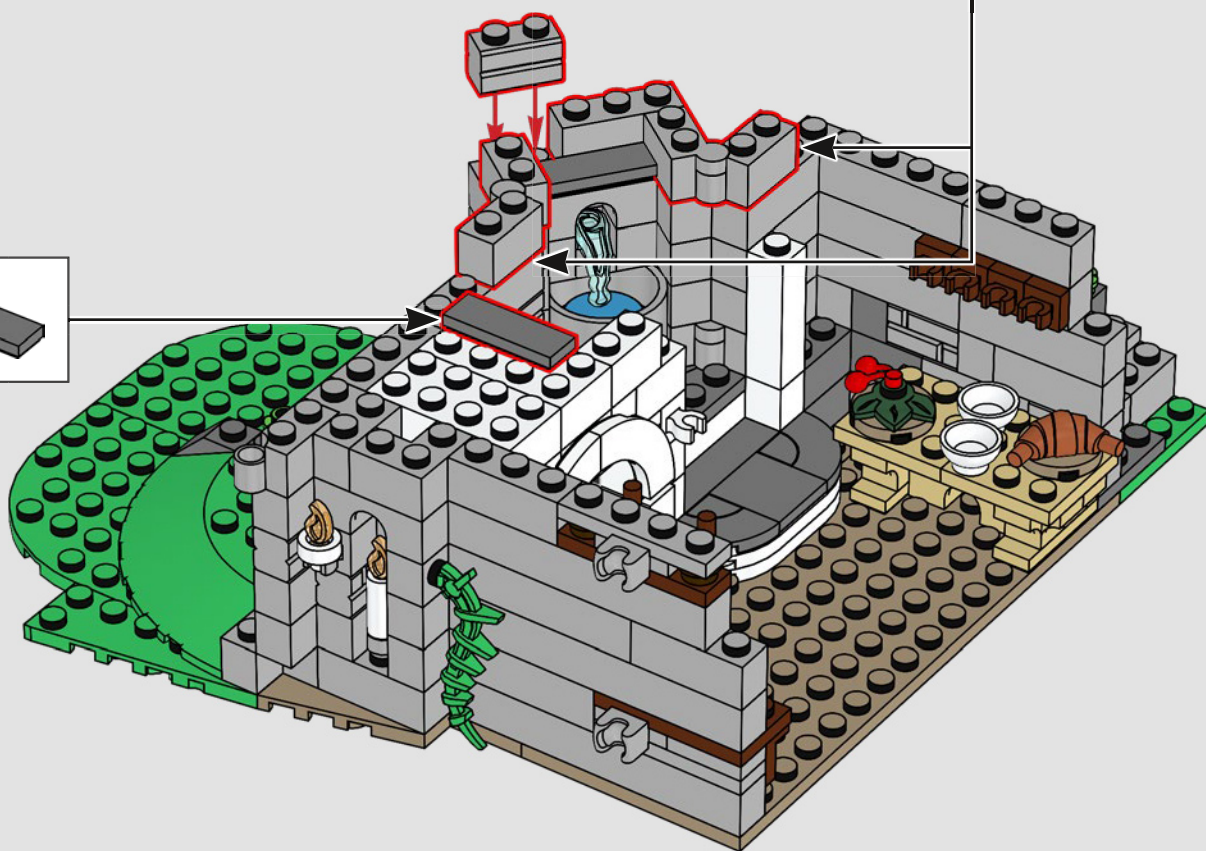
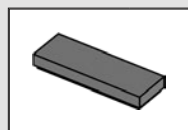
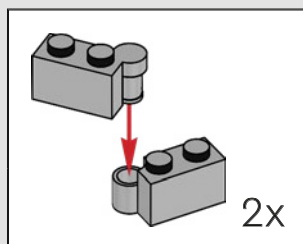

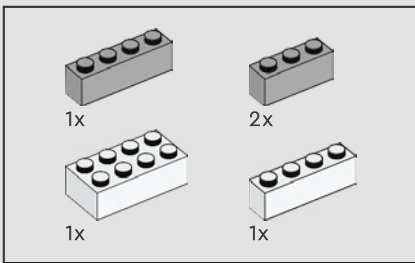

38

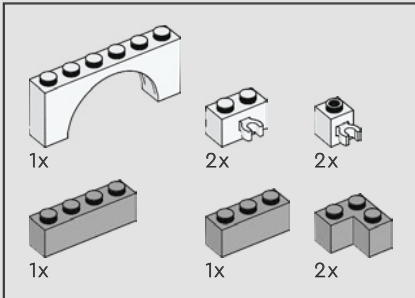
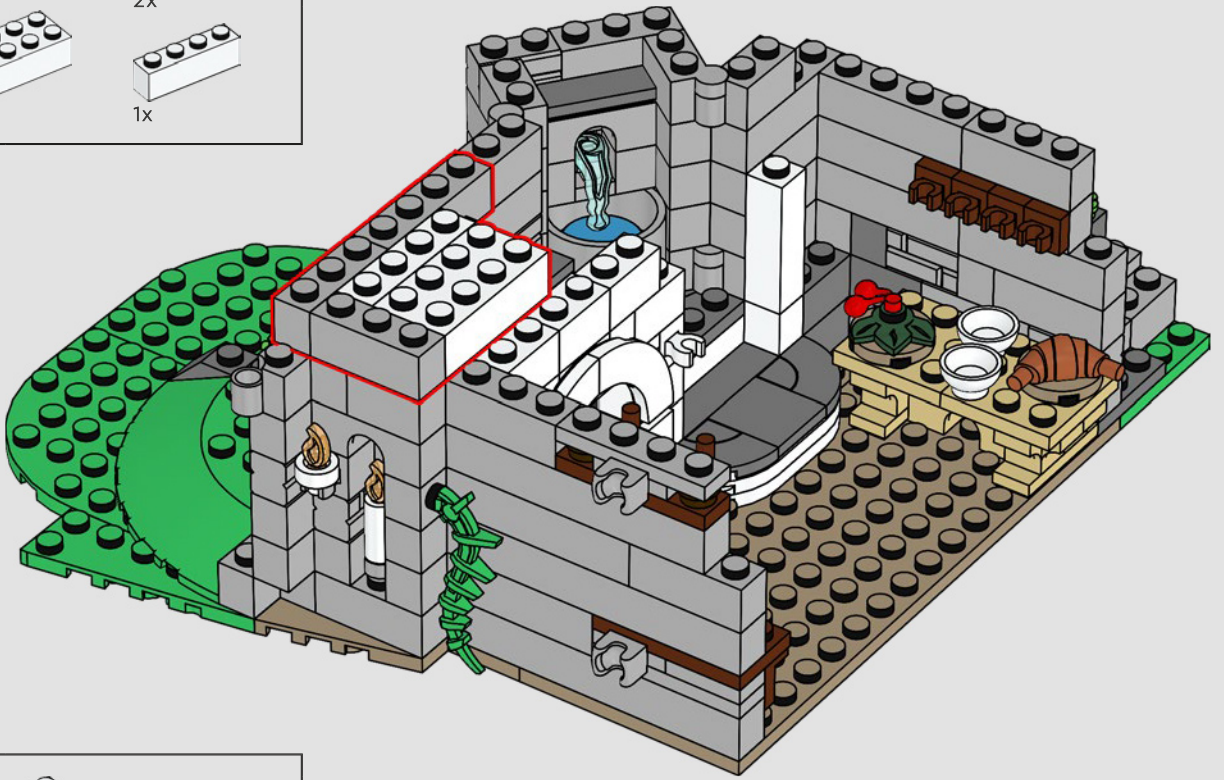

39

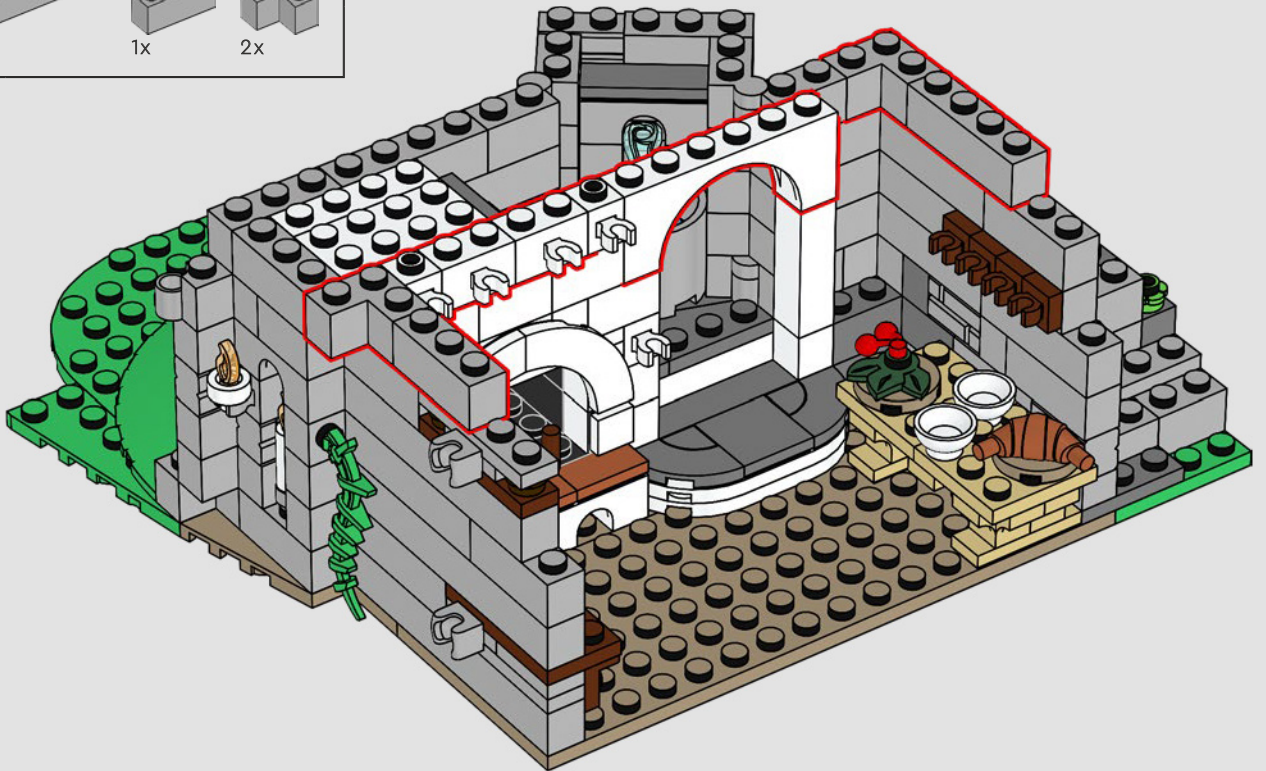



40

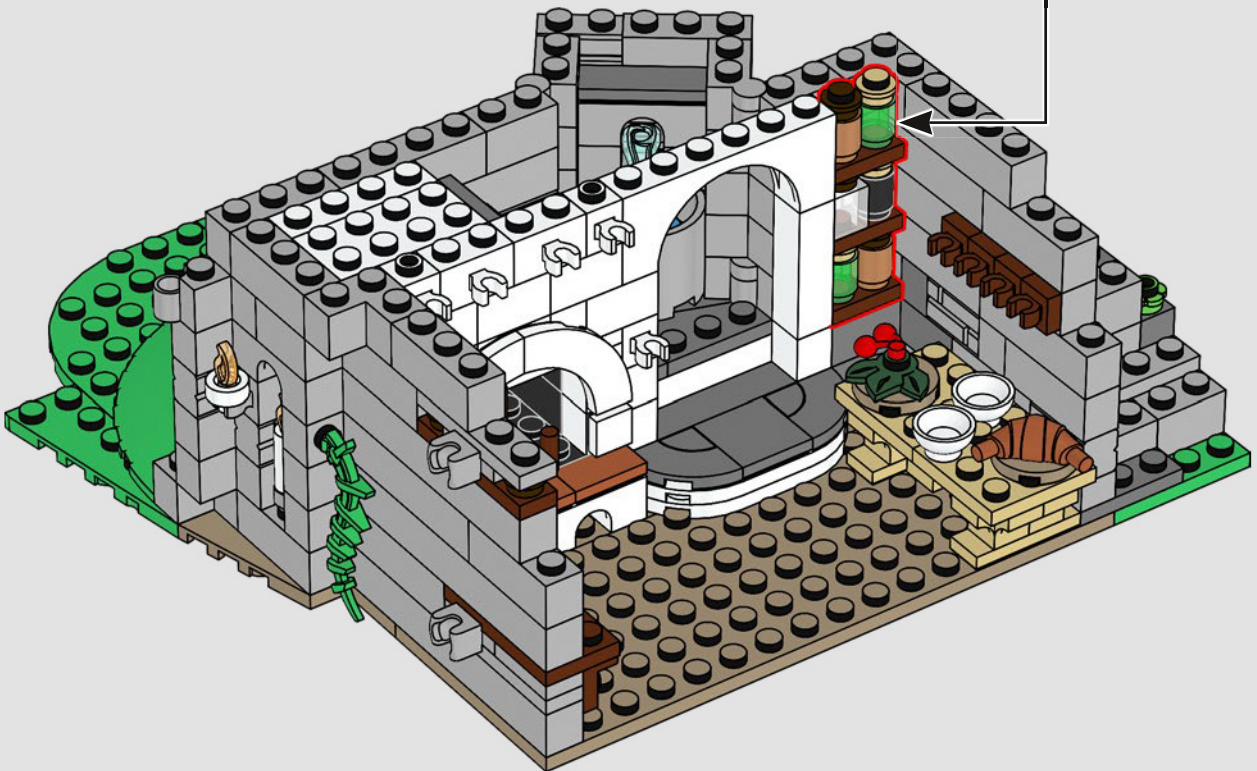
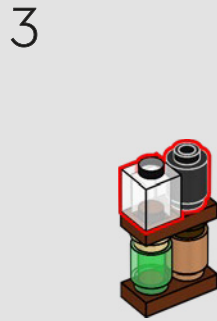
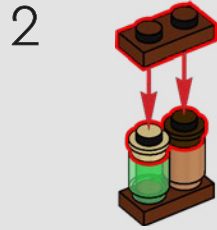
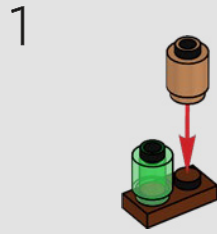

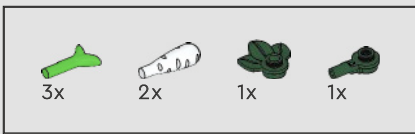

Ce sont des navets, ou des carottes ? Si seulement leur couleur n'était pas aussi semblable.

41

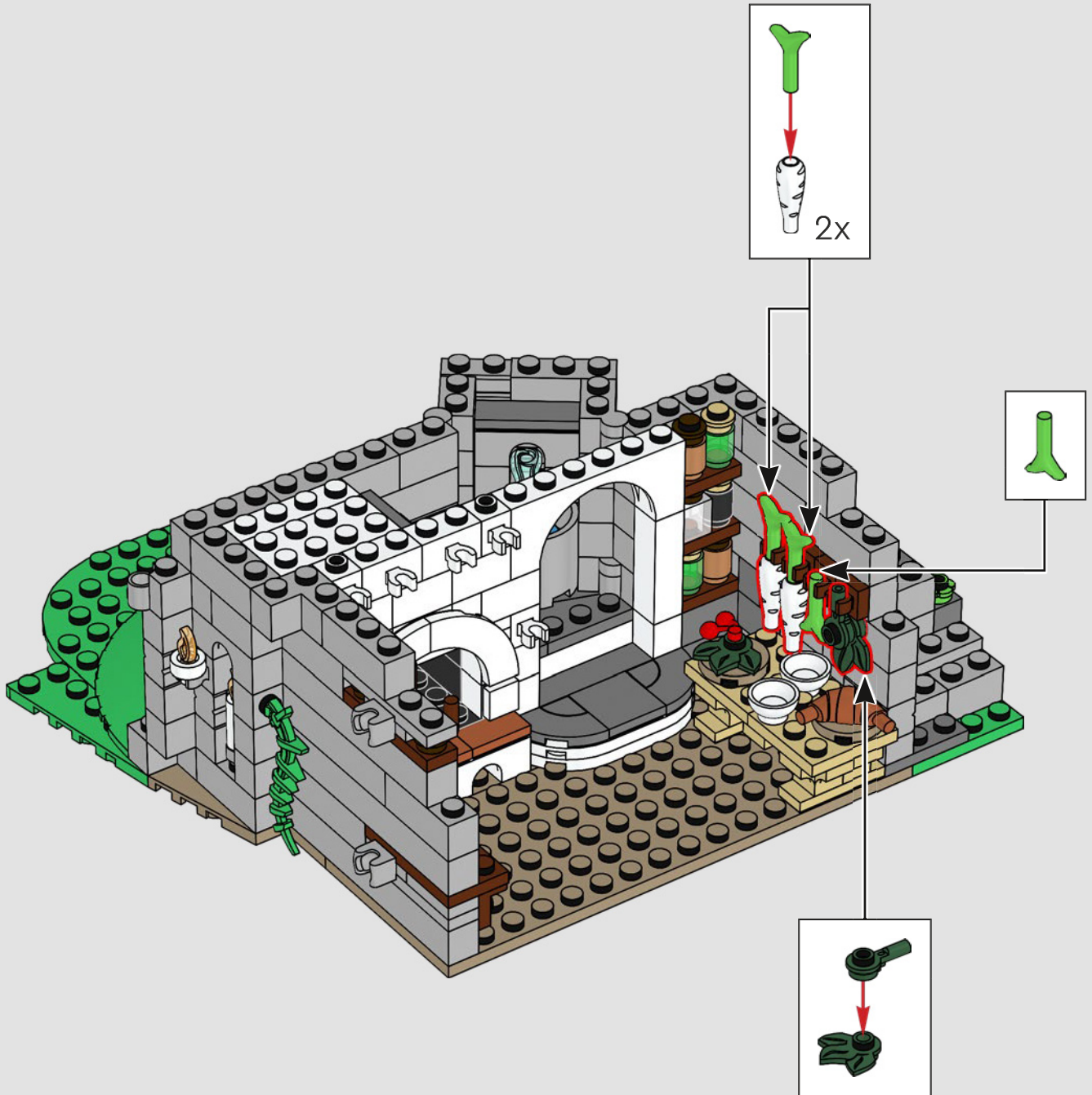



42

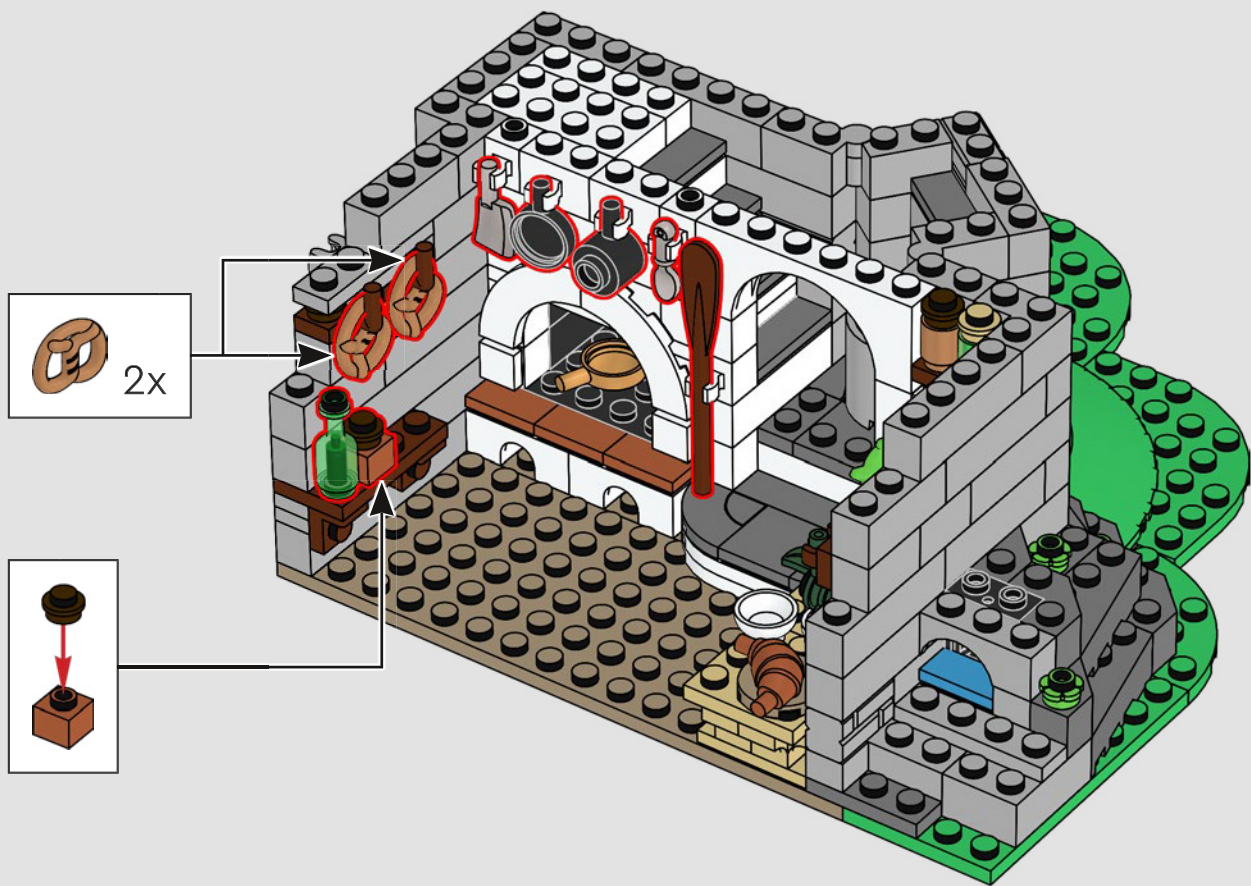

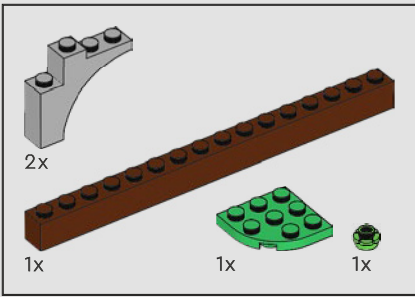

43

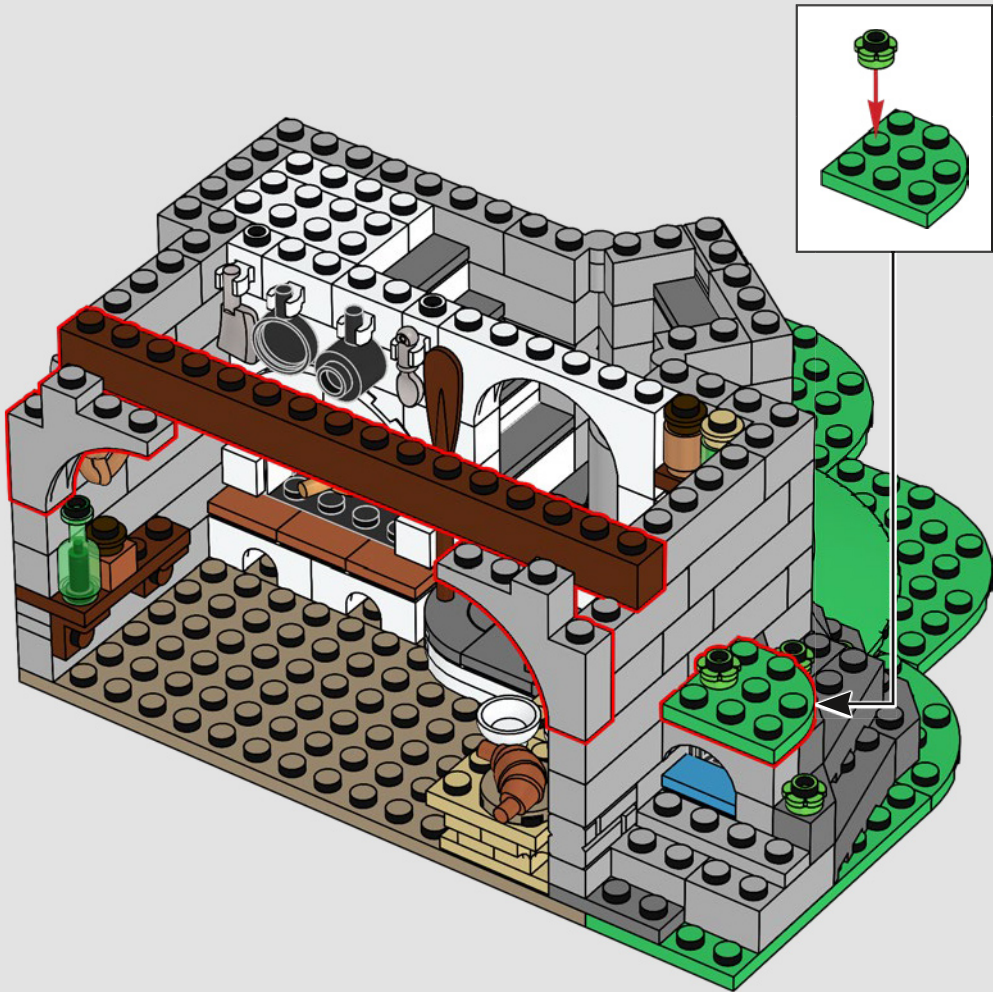

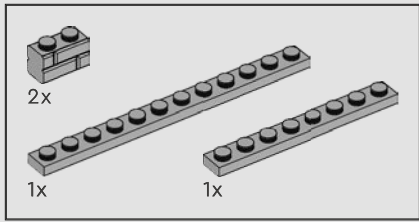

44

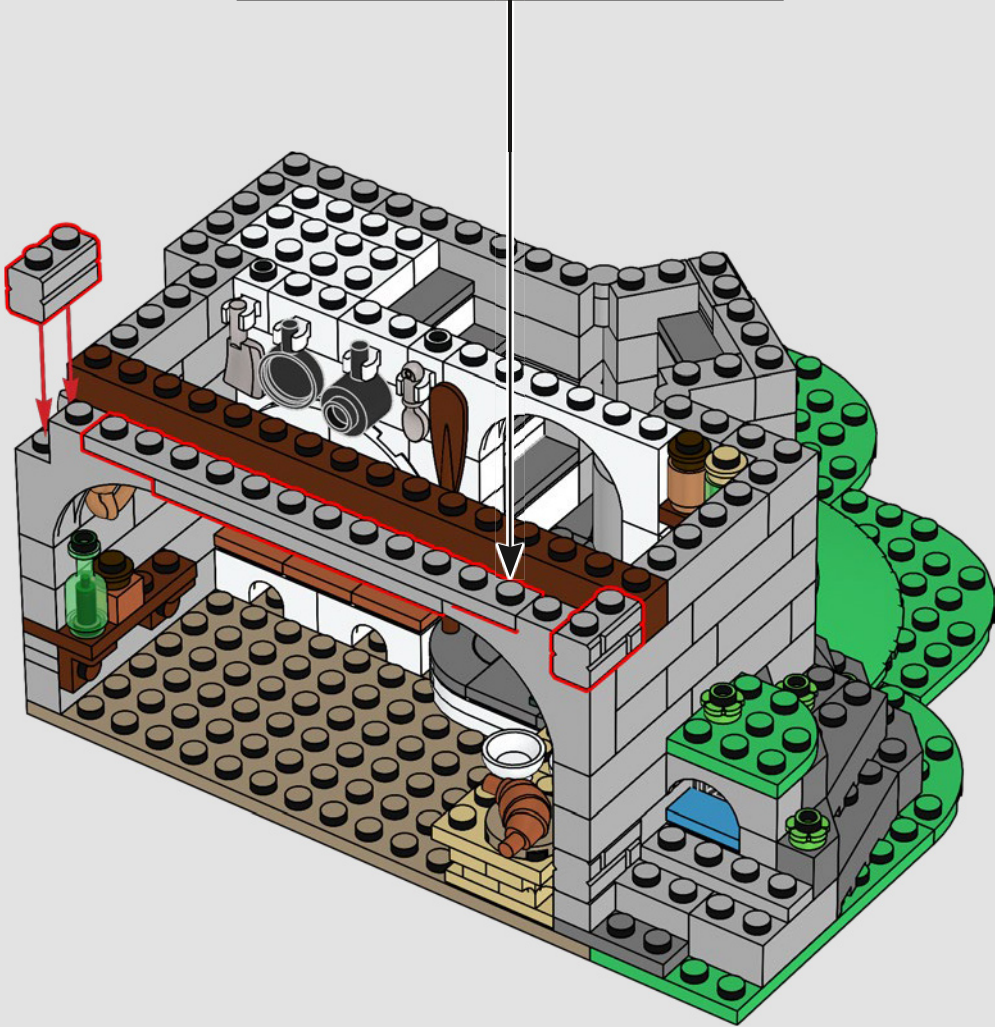
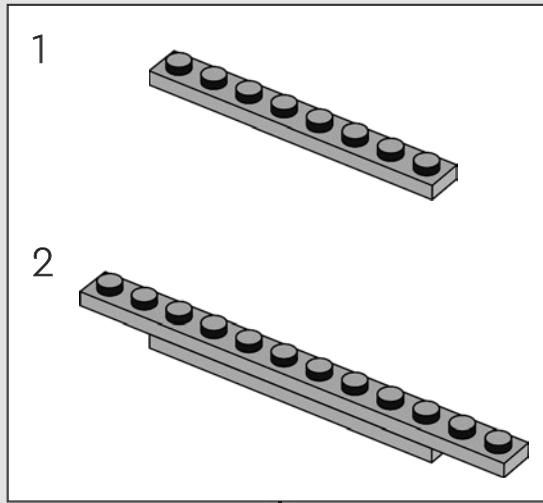

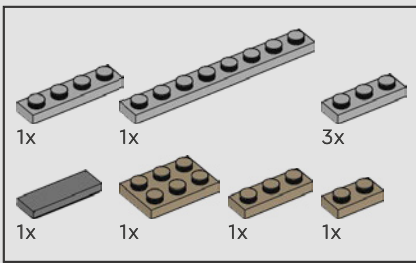

45

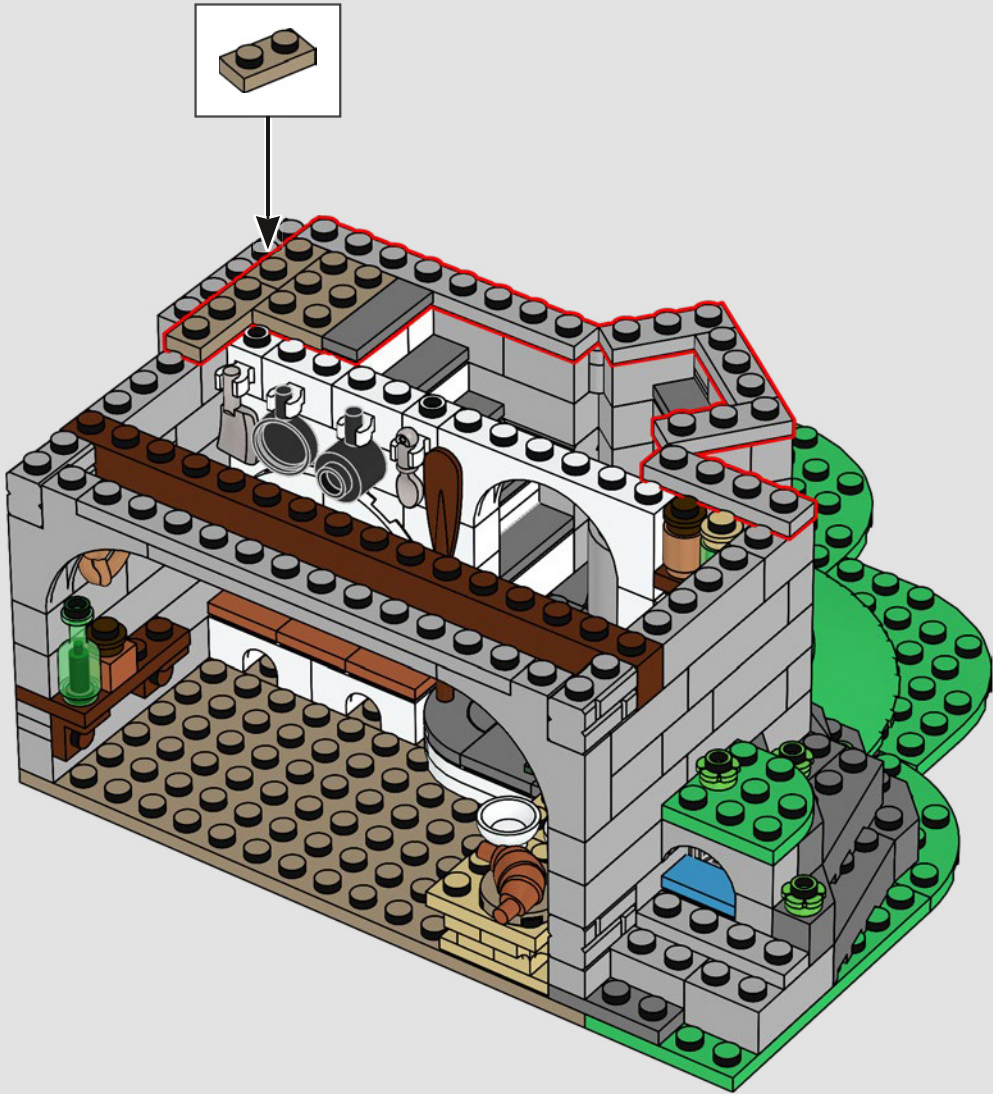

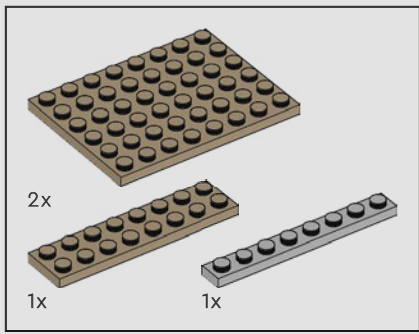

46

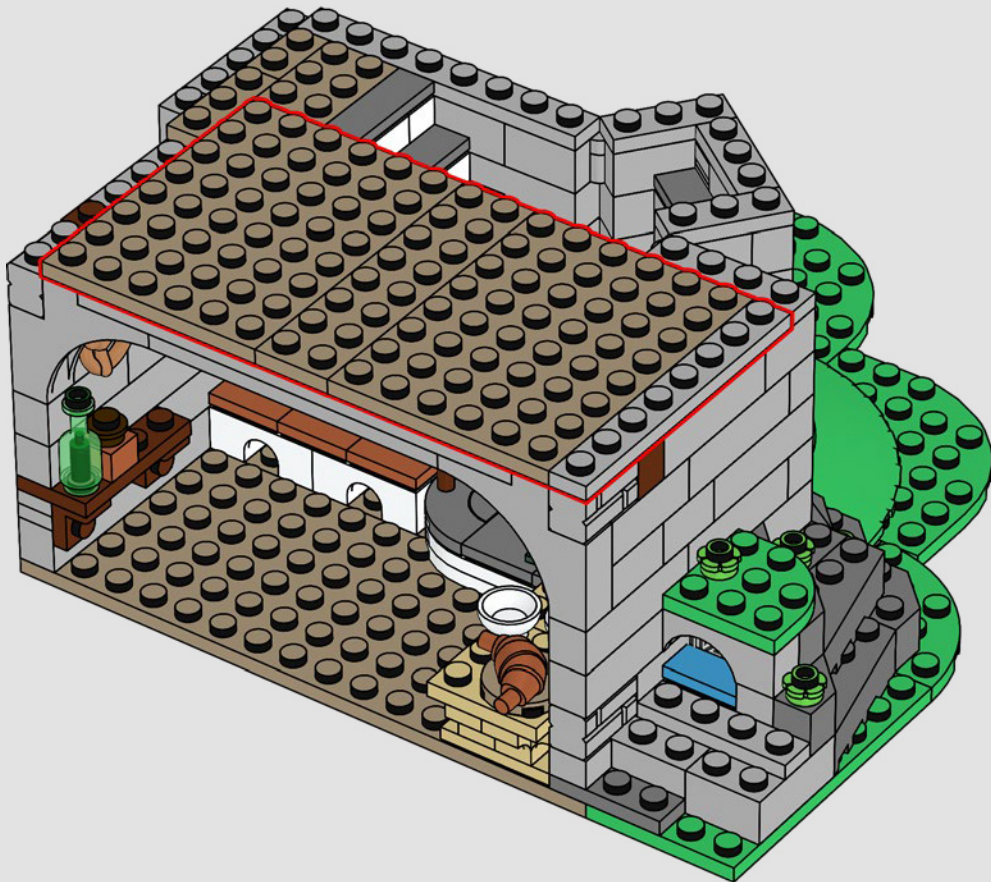

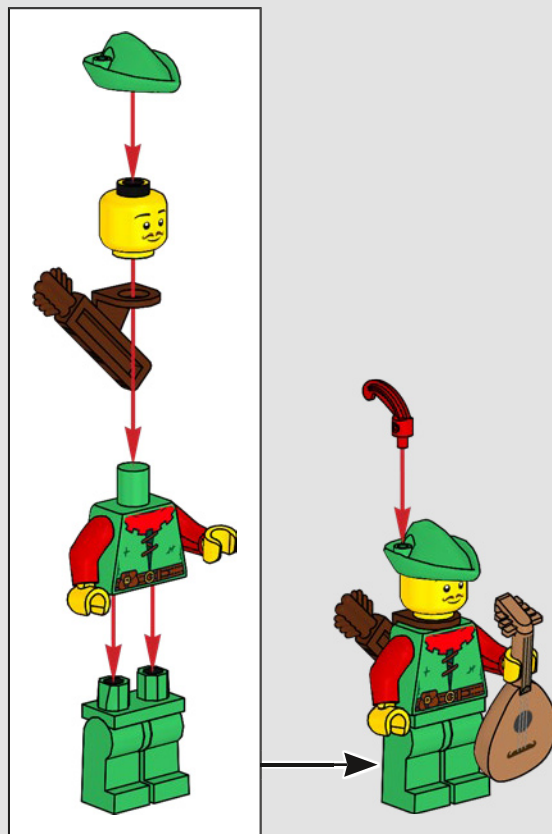

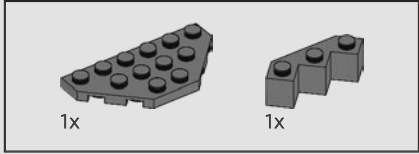
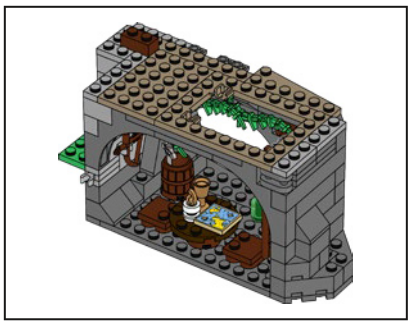

47

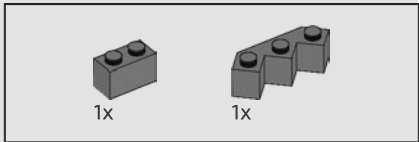
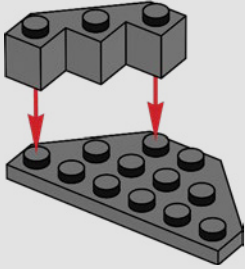

48

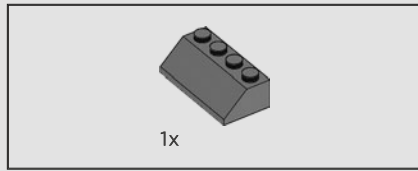
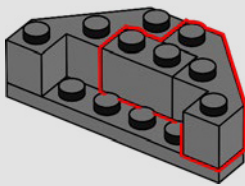

49

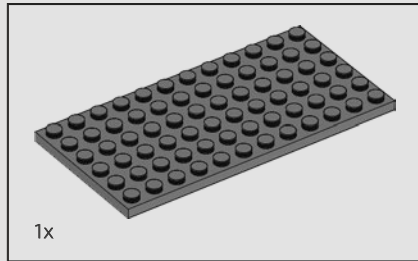
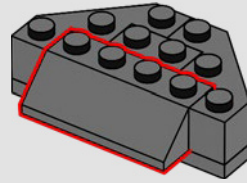

50

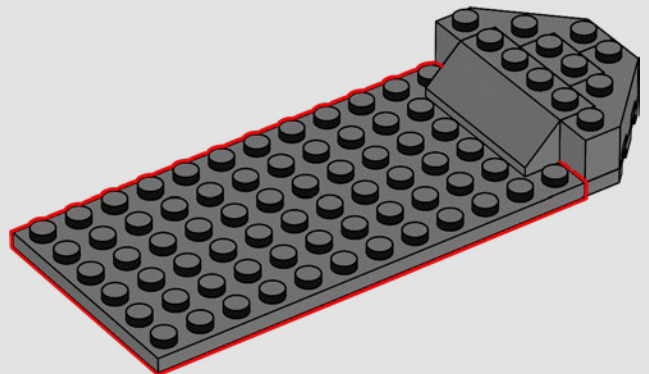

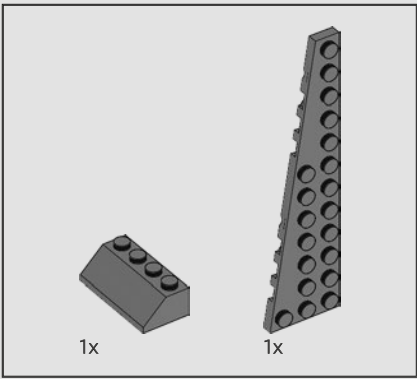

51

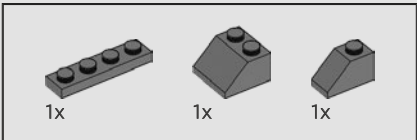
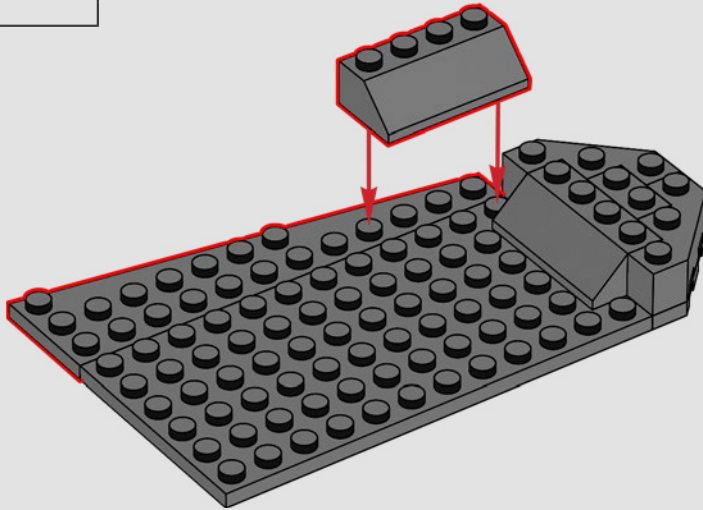

52

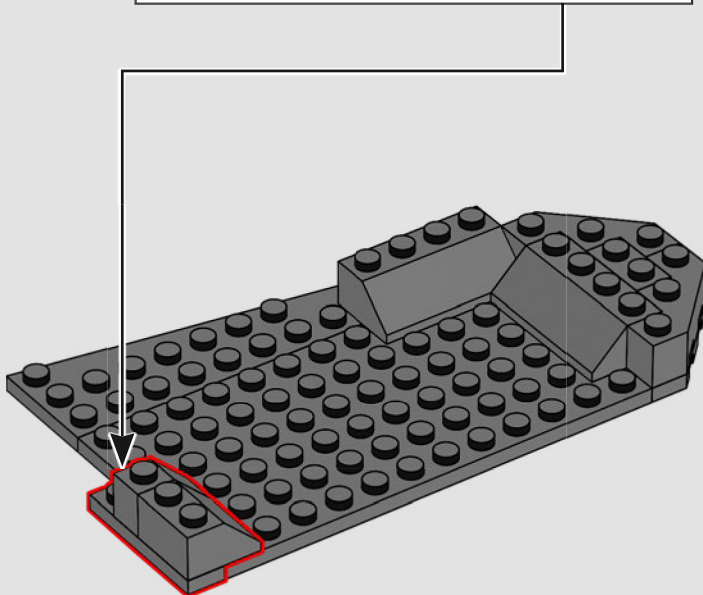
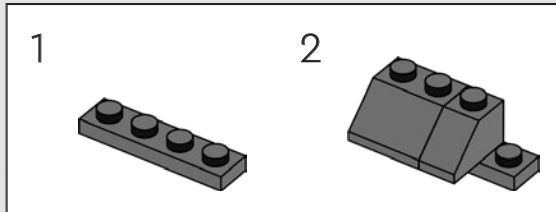

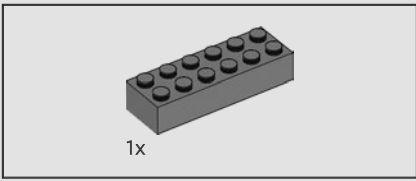

53

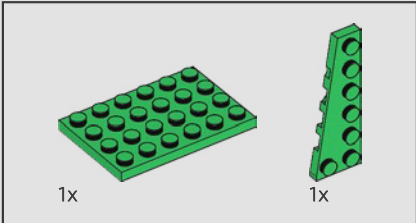
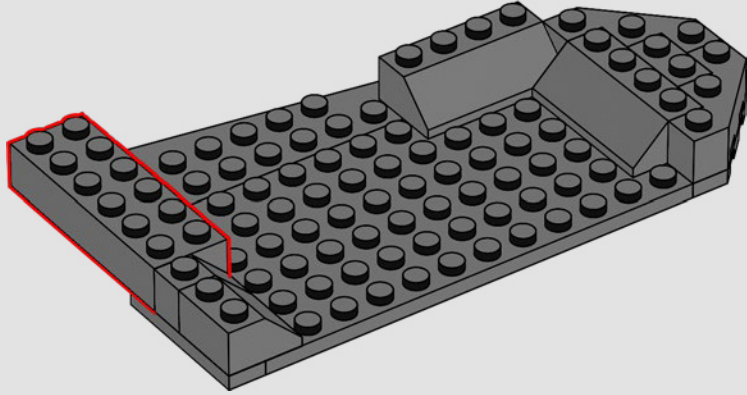

54

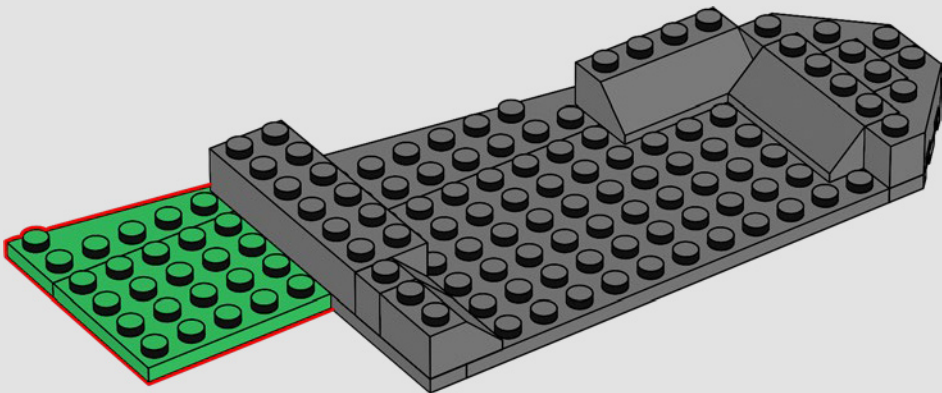

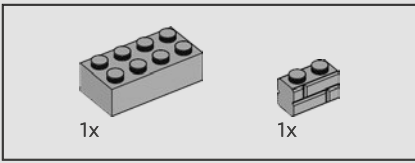

55

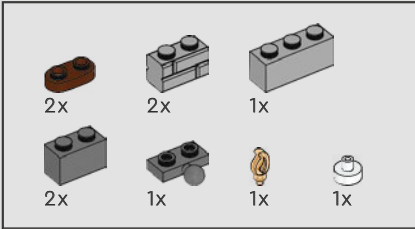
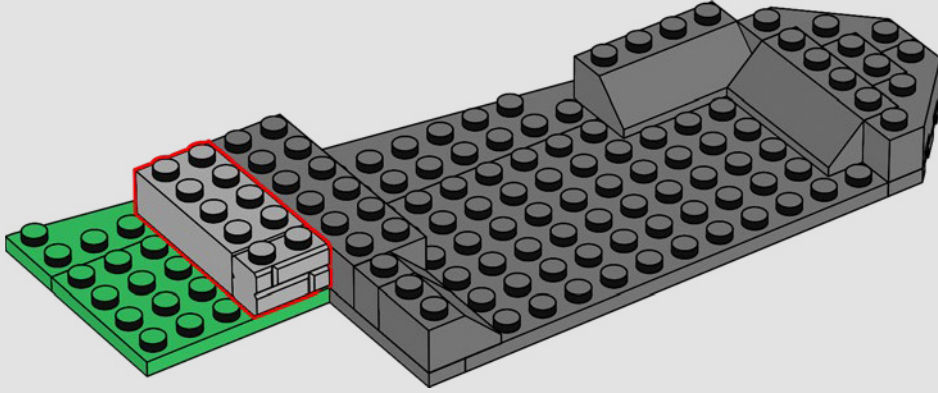

56

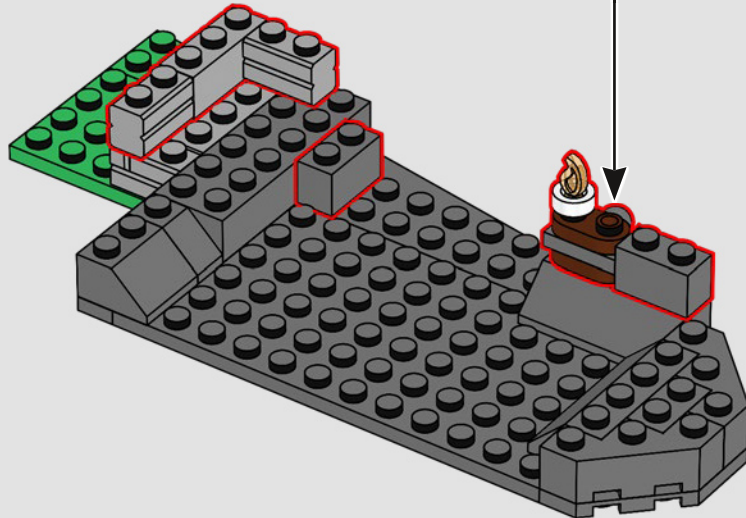
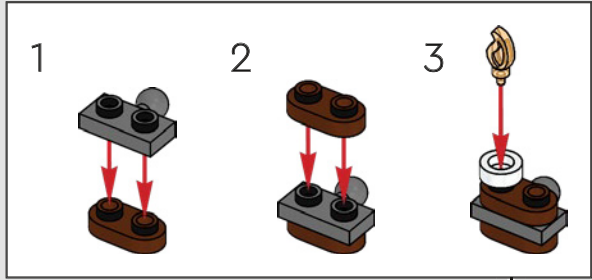

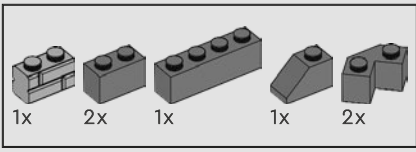

57

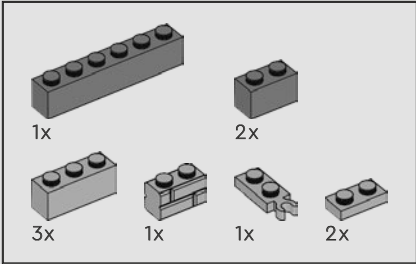
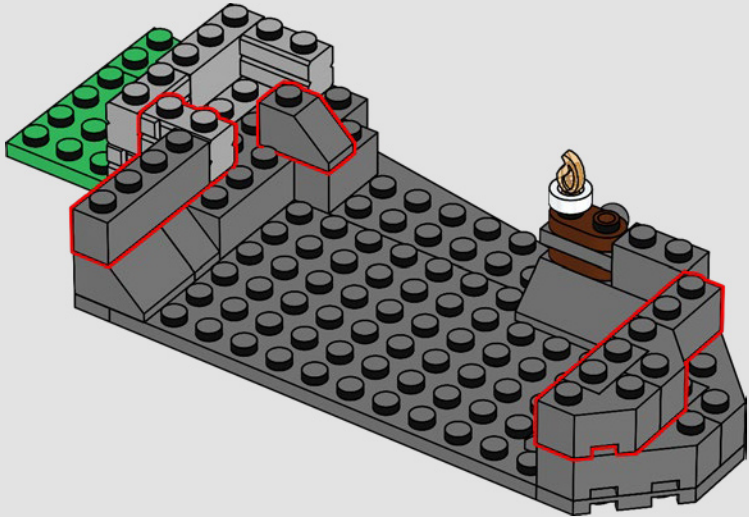

58

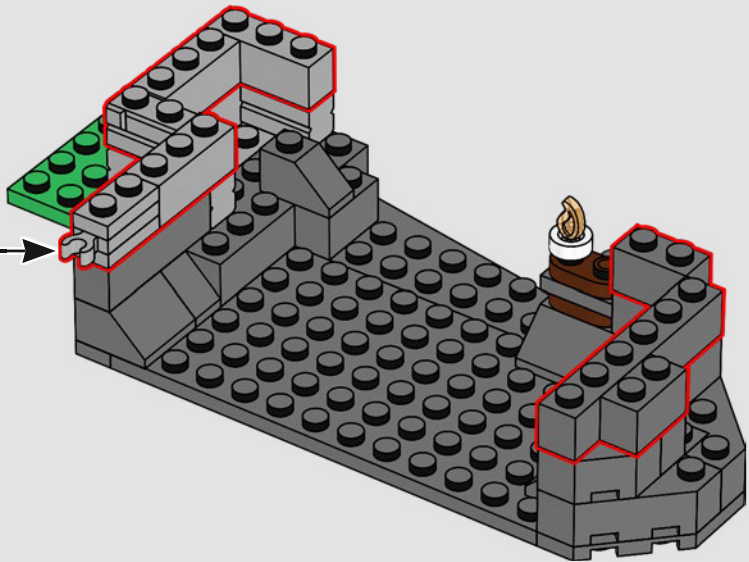
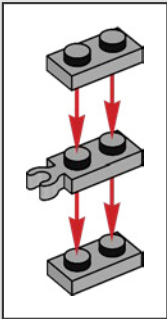

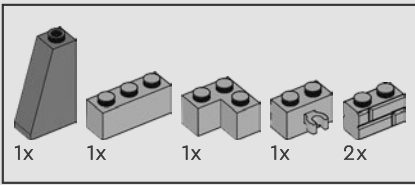

59

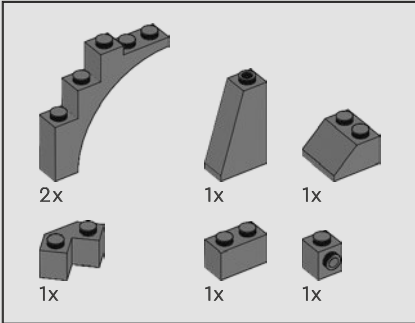
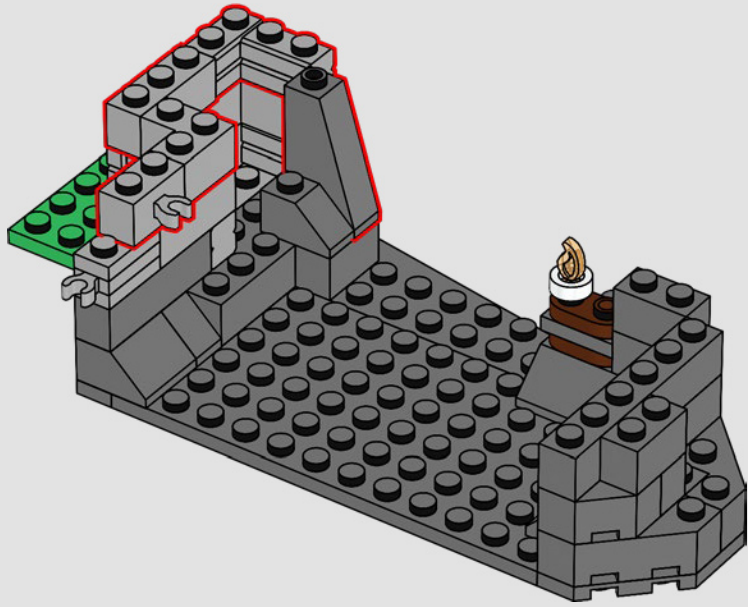

60

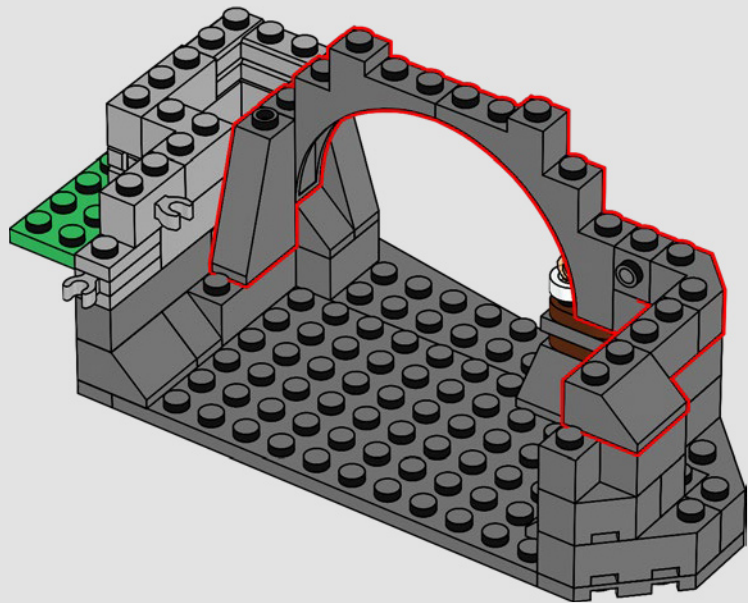

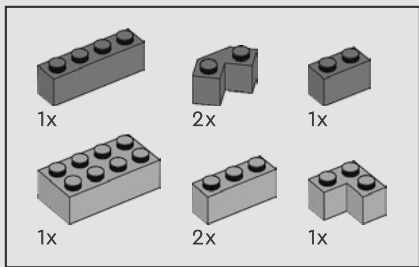

61

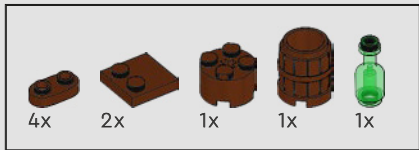
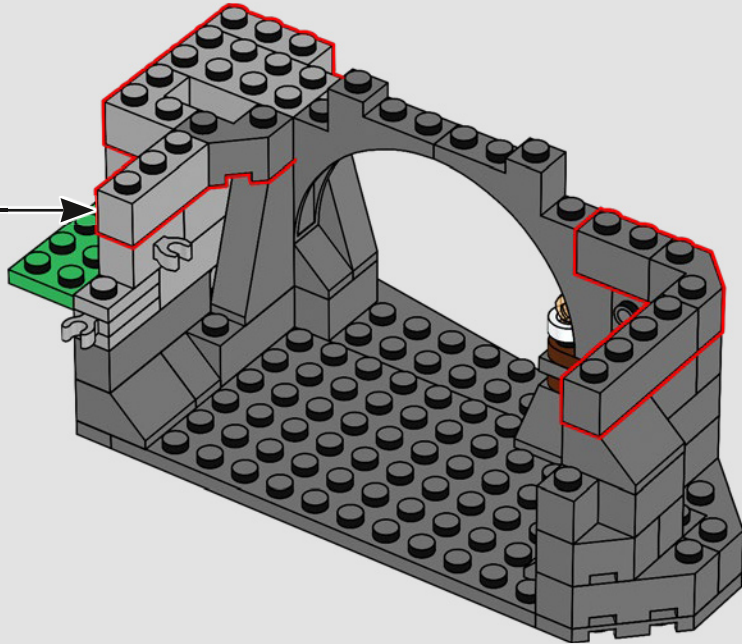
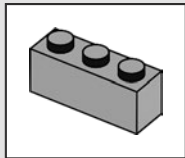

62

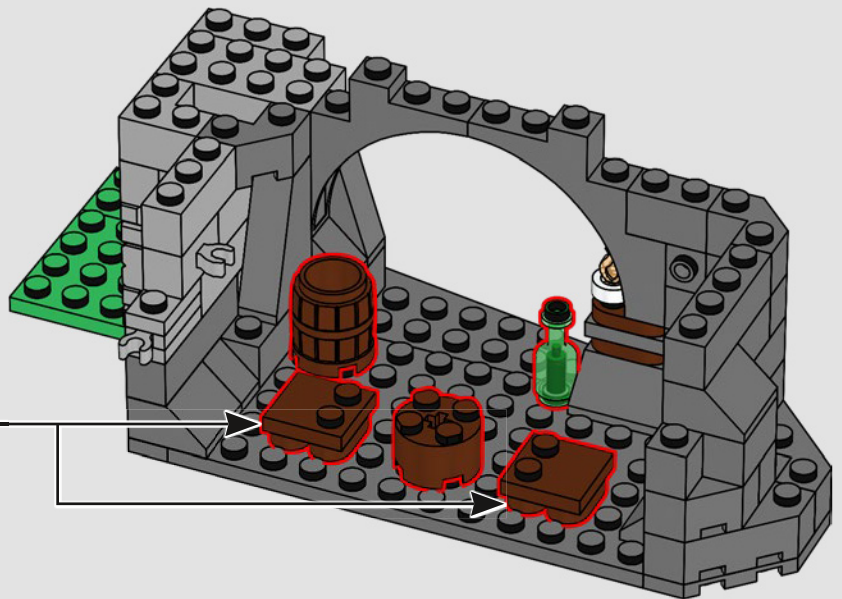
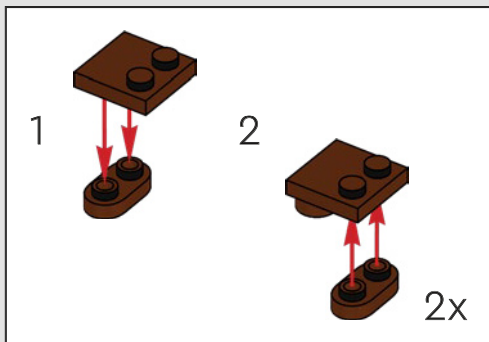



Un archer pourrait très bien s'entraîner avec cette cible.

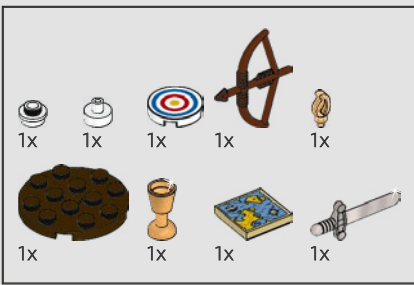

63

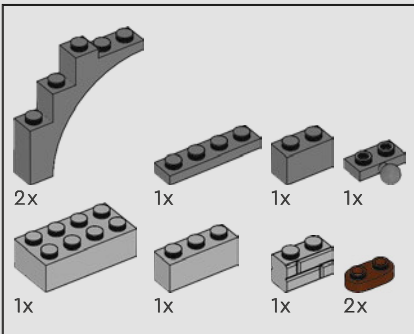
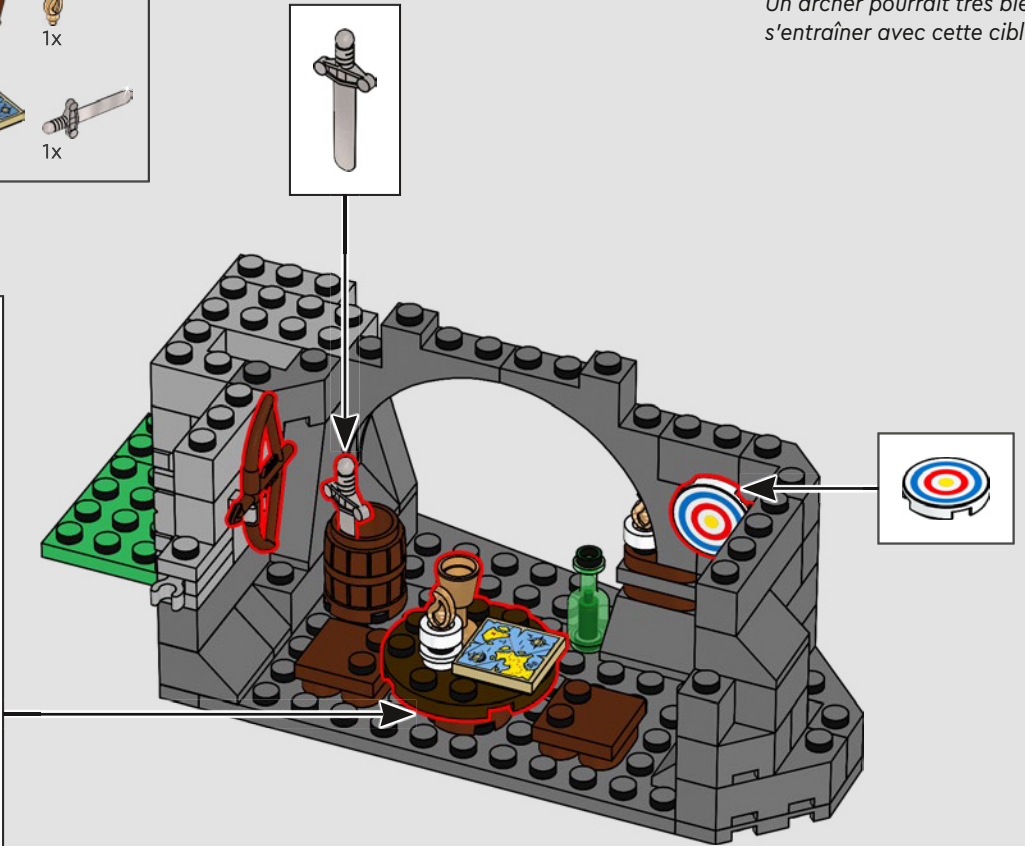
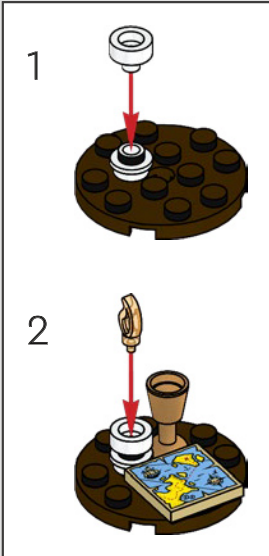

64

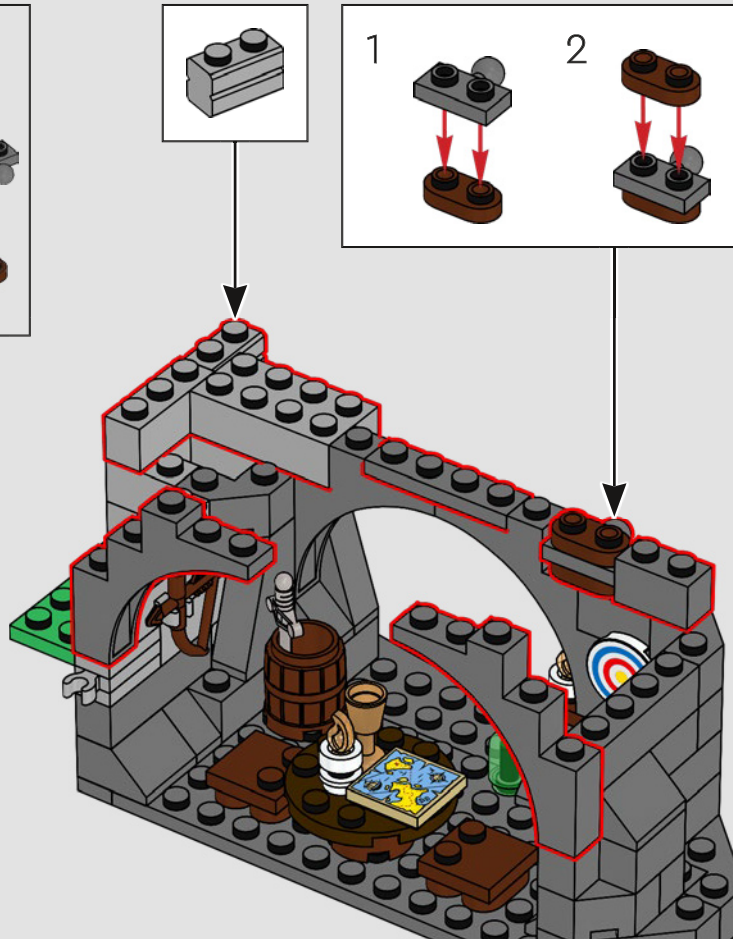

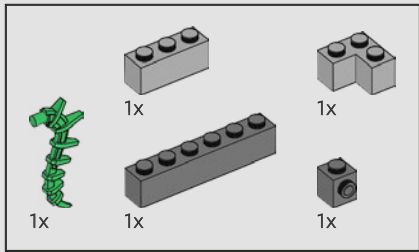

65

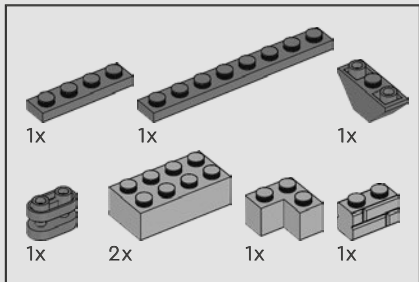
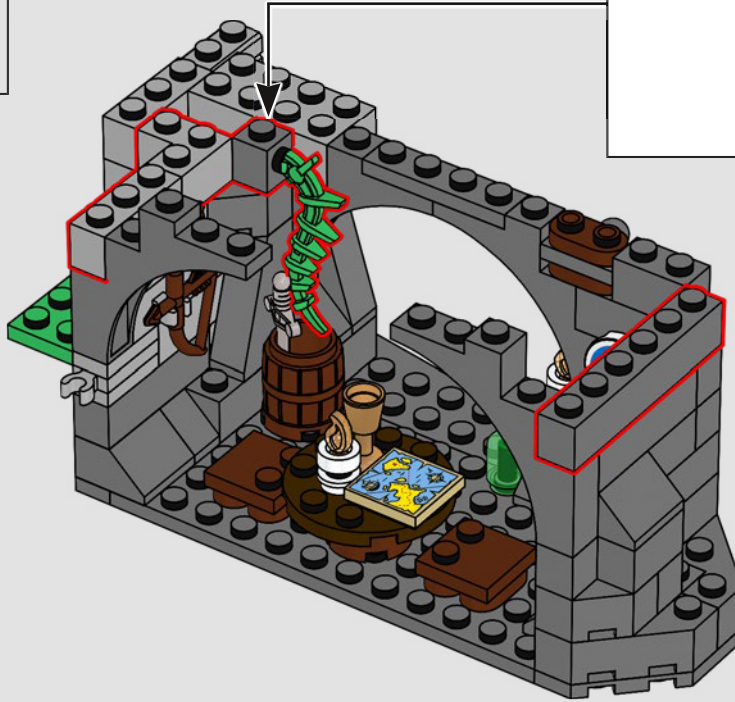
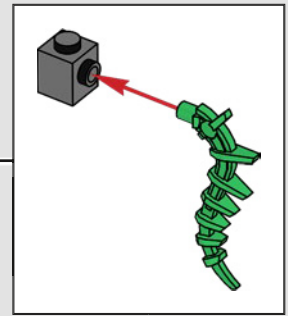

66

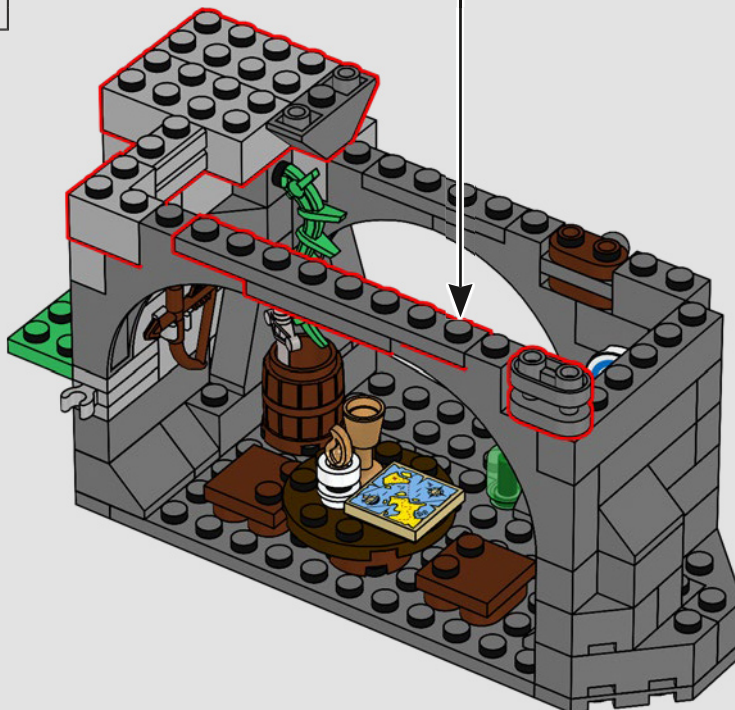
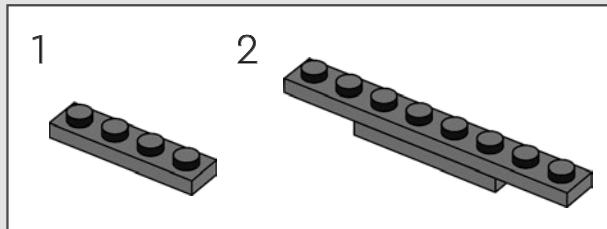

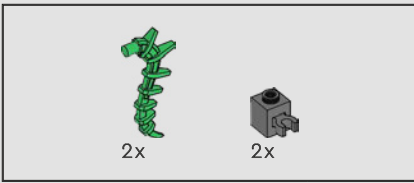

67

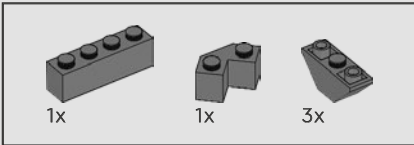
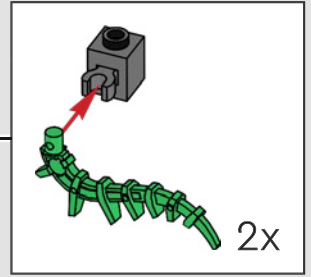
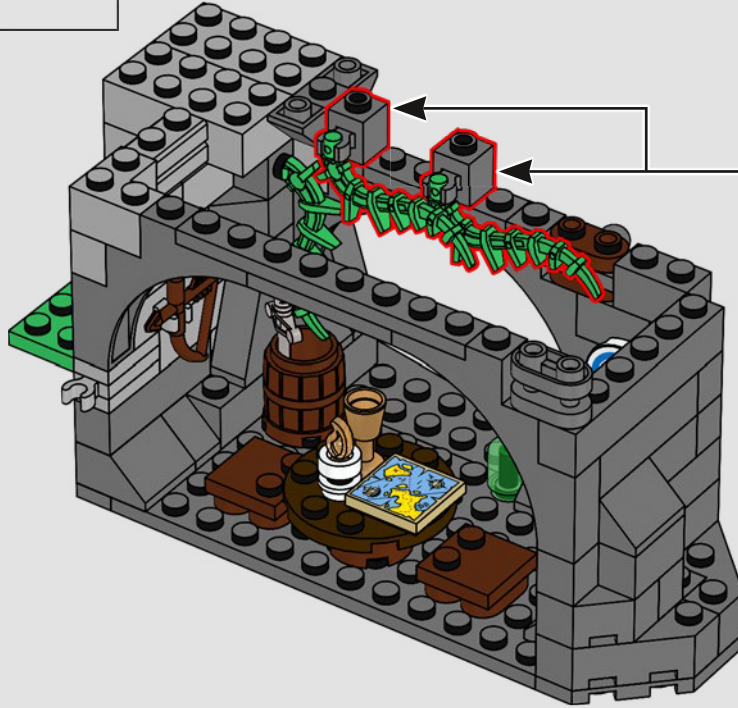

68

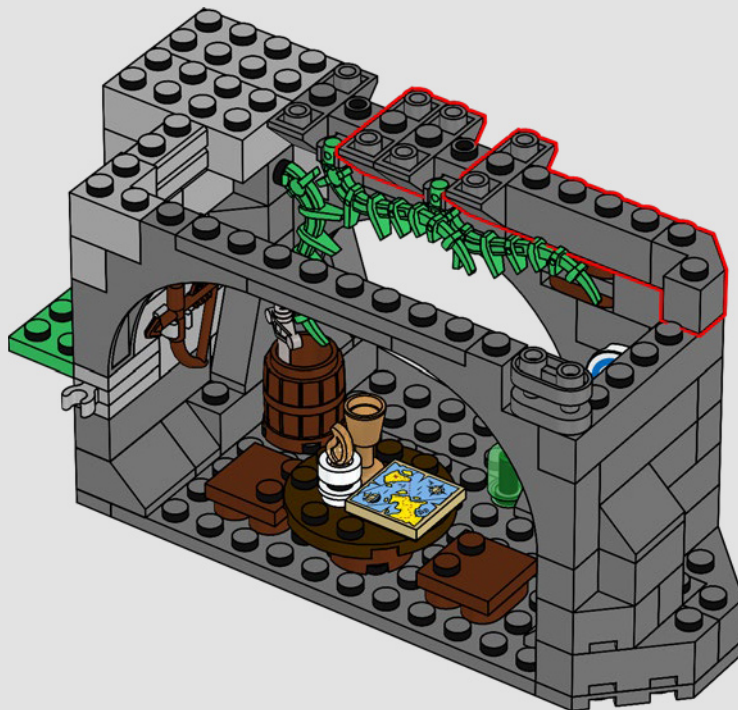

Cette carte est tout à fait singulière. Que pourrait bien représenter tout ce bleu ? Aucune mer n'est aussi grande...

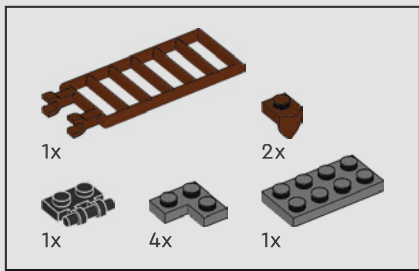

69

1

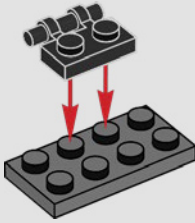

2

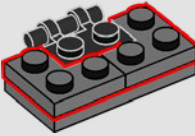

3

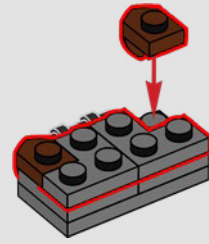

4

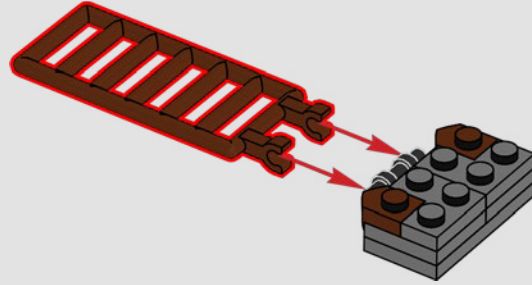

5

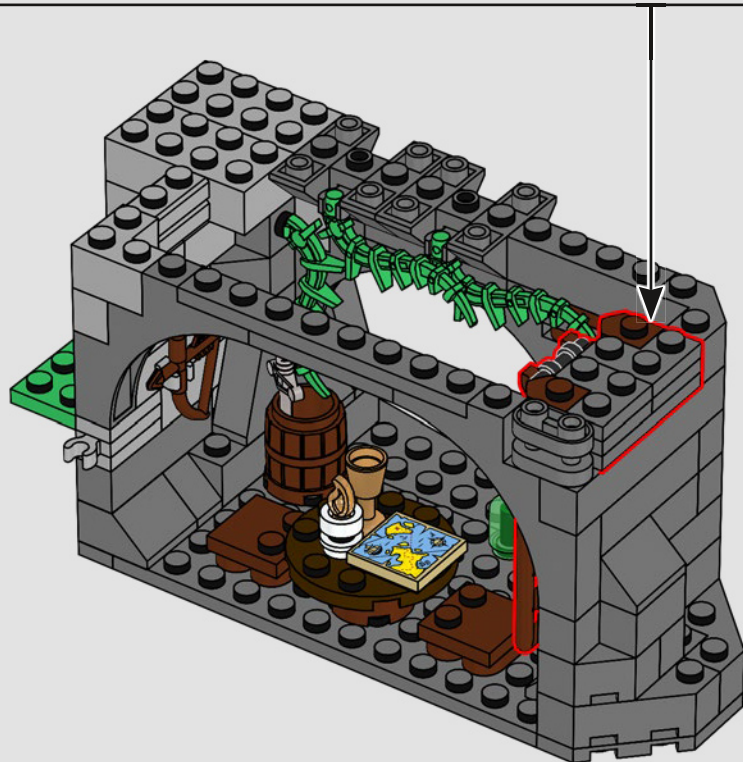
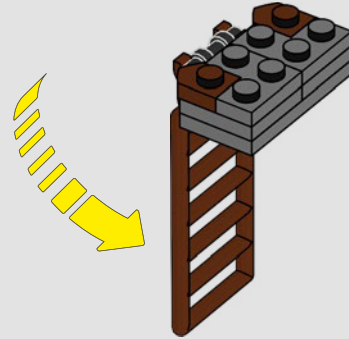

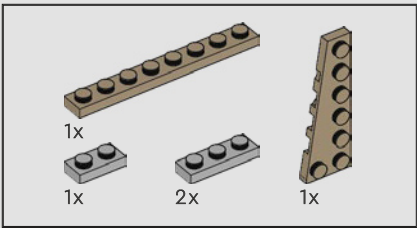

70

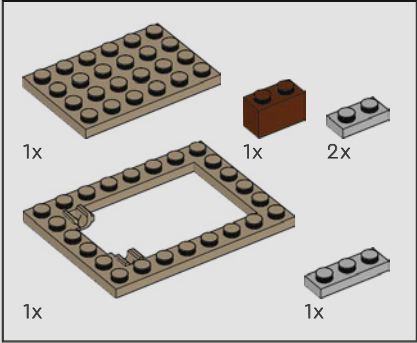
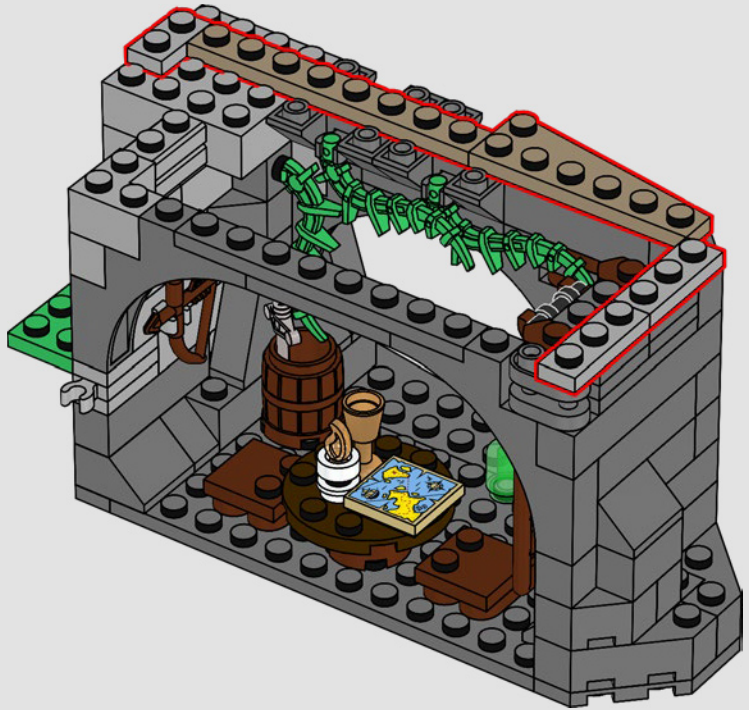

71

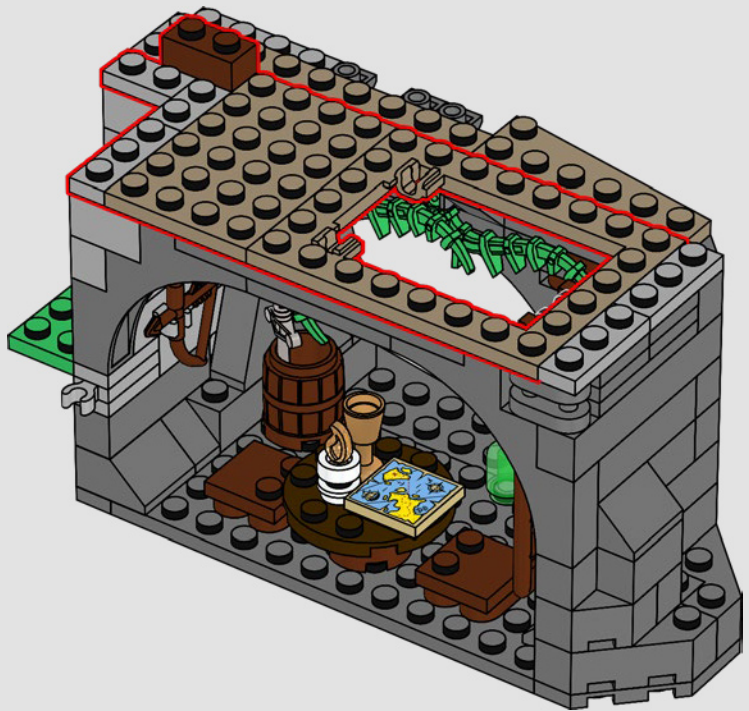

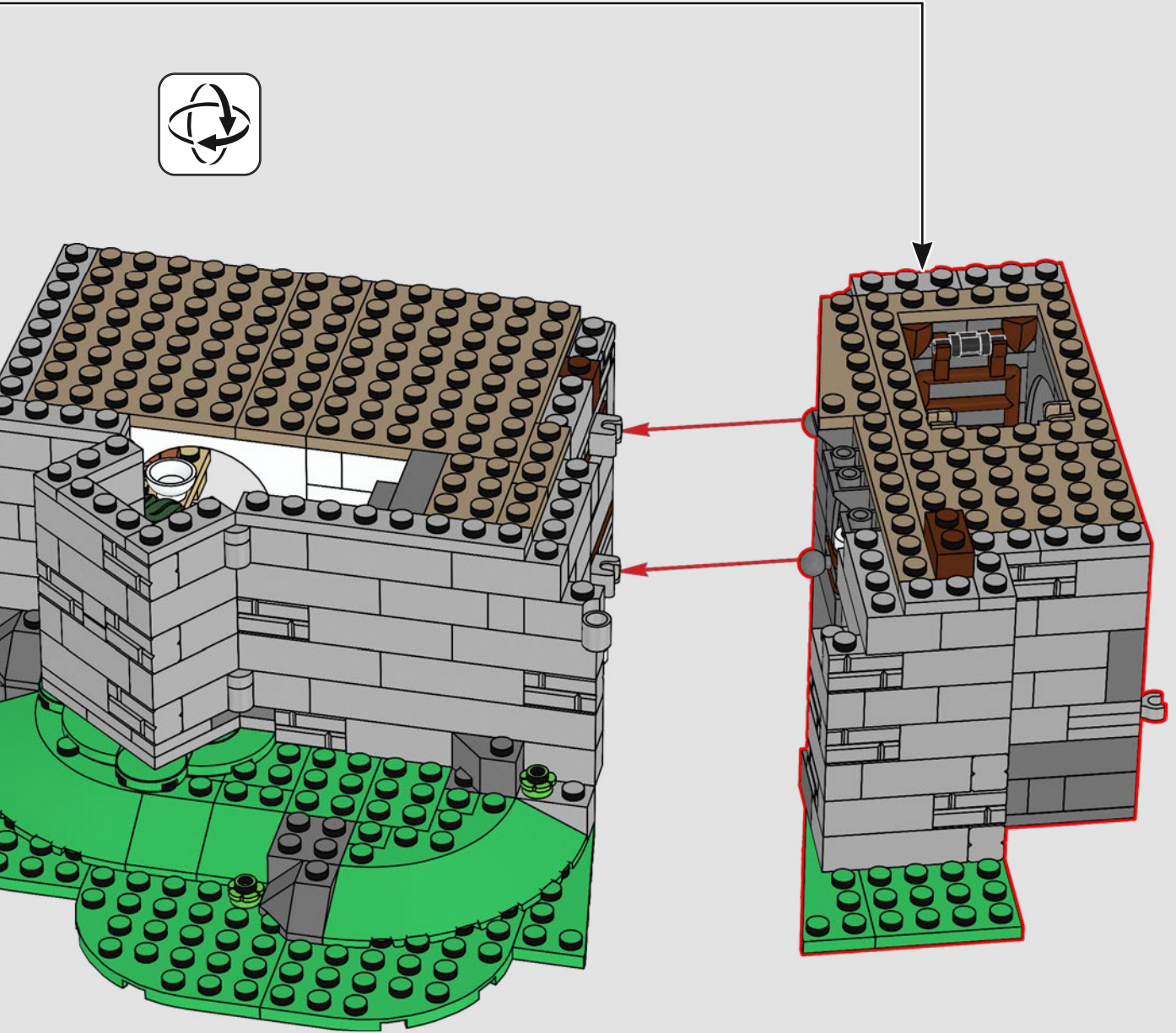

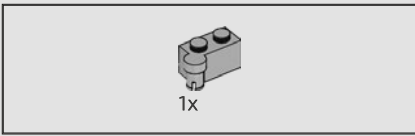

73

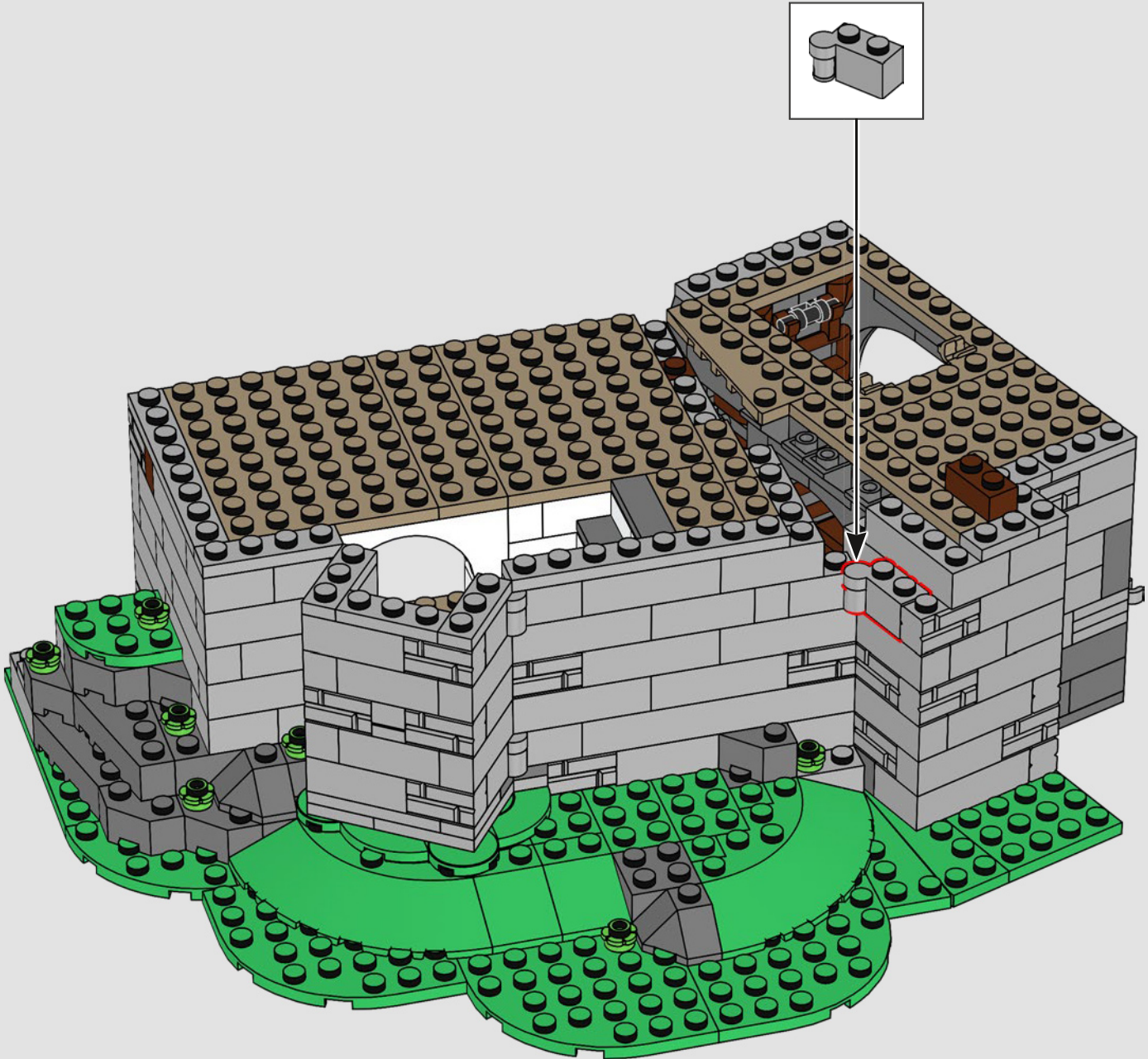

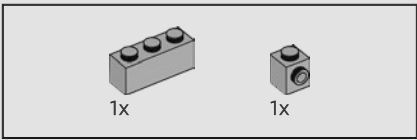

74

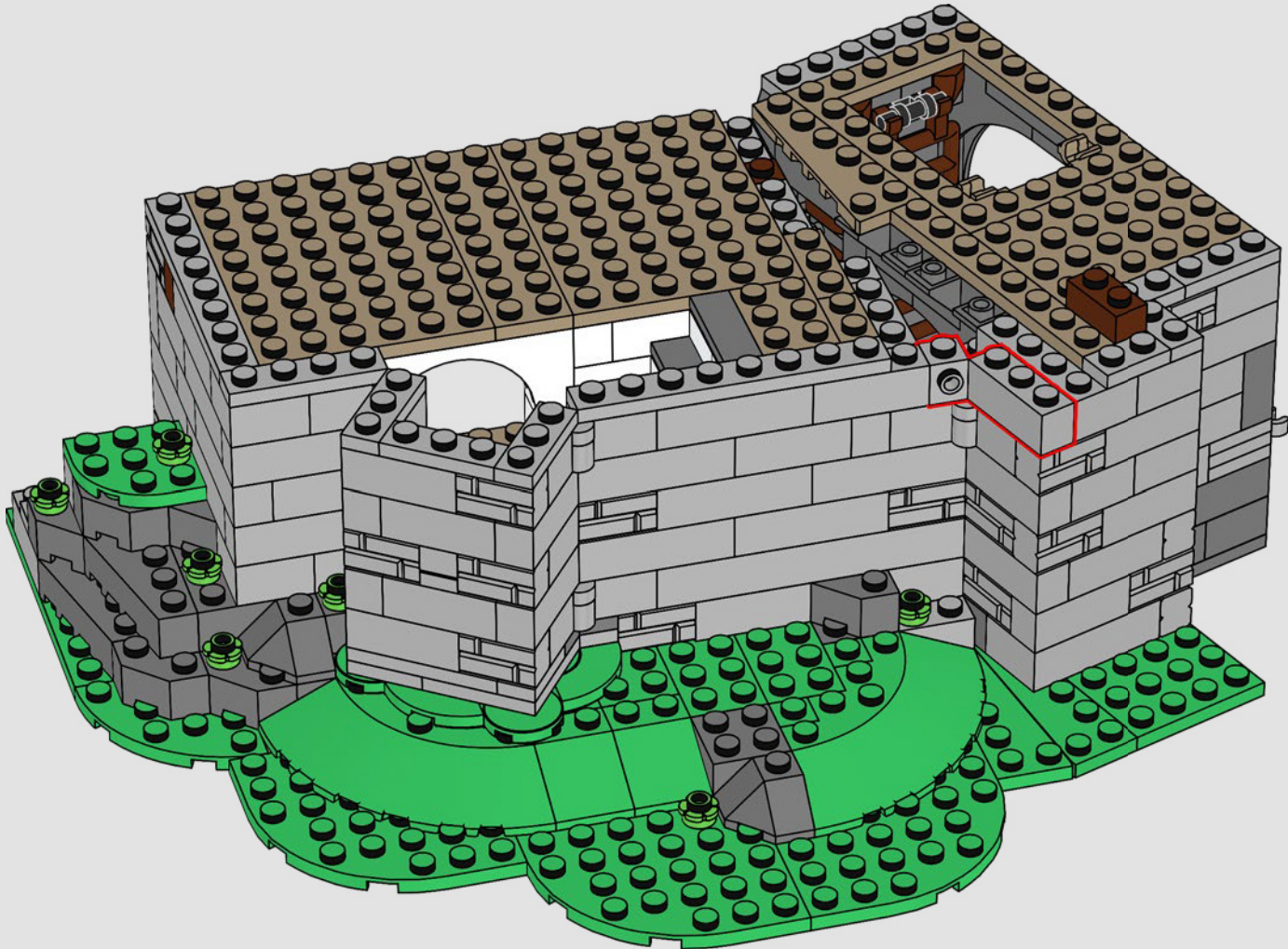

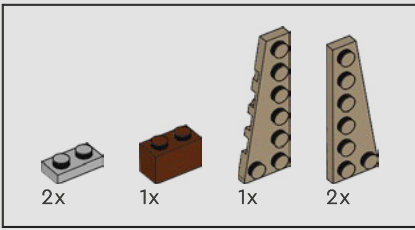

75

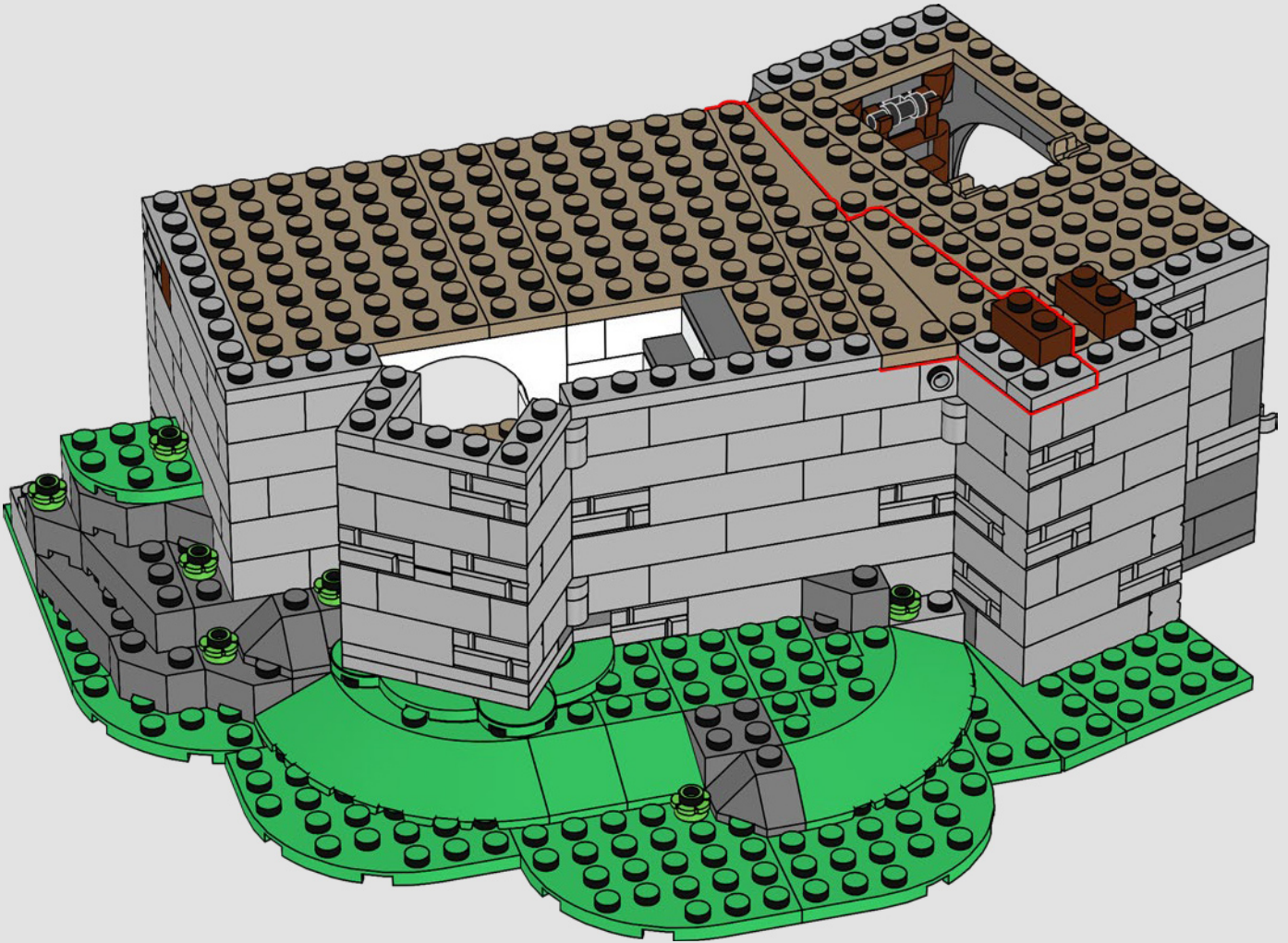

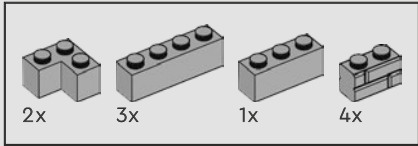

76

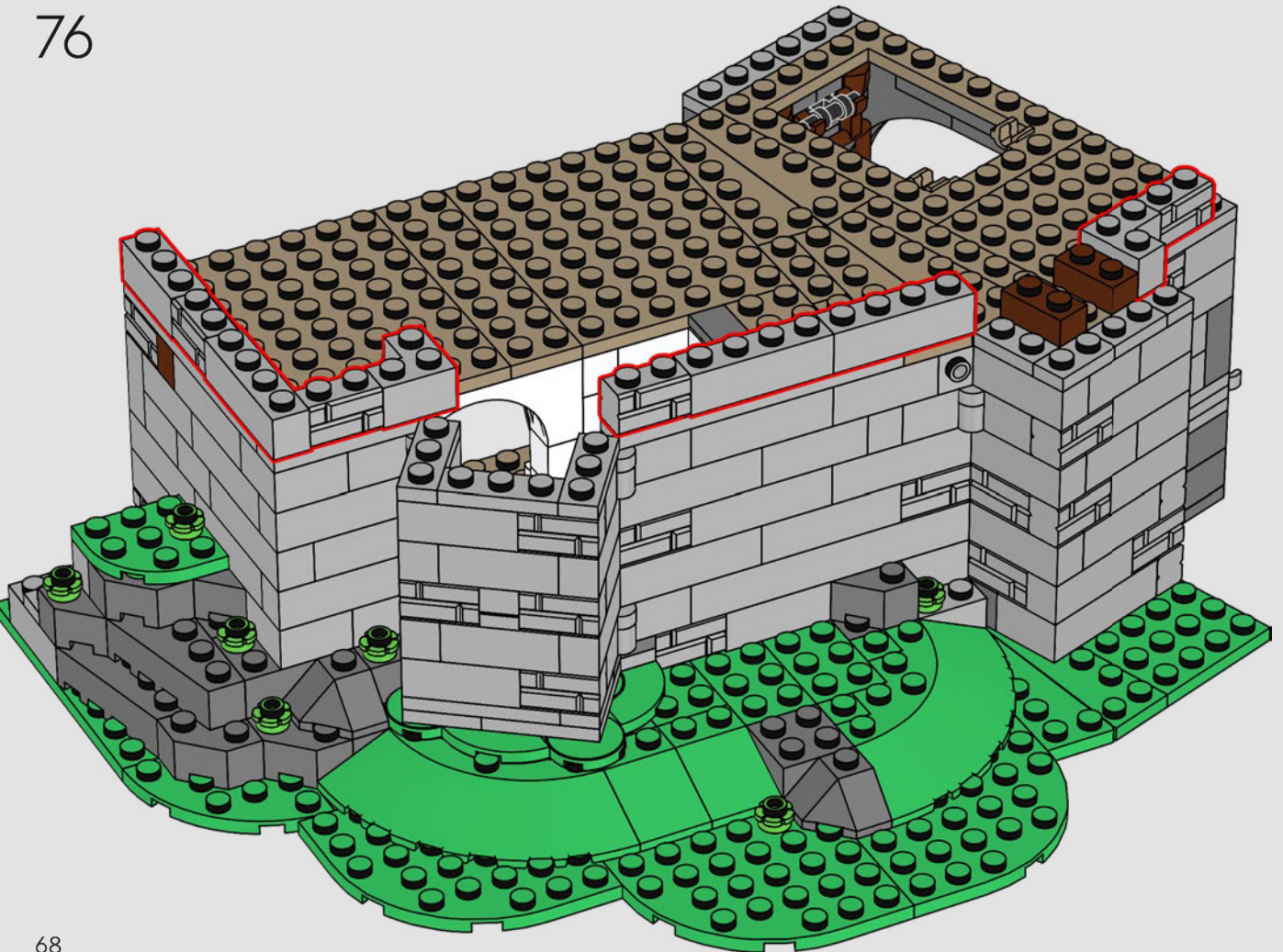

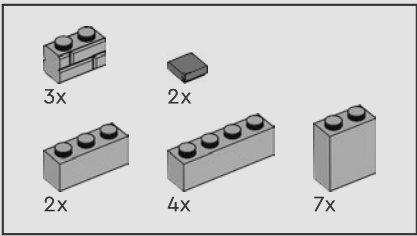

77

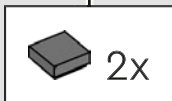
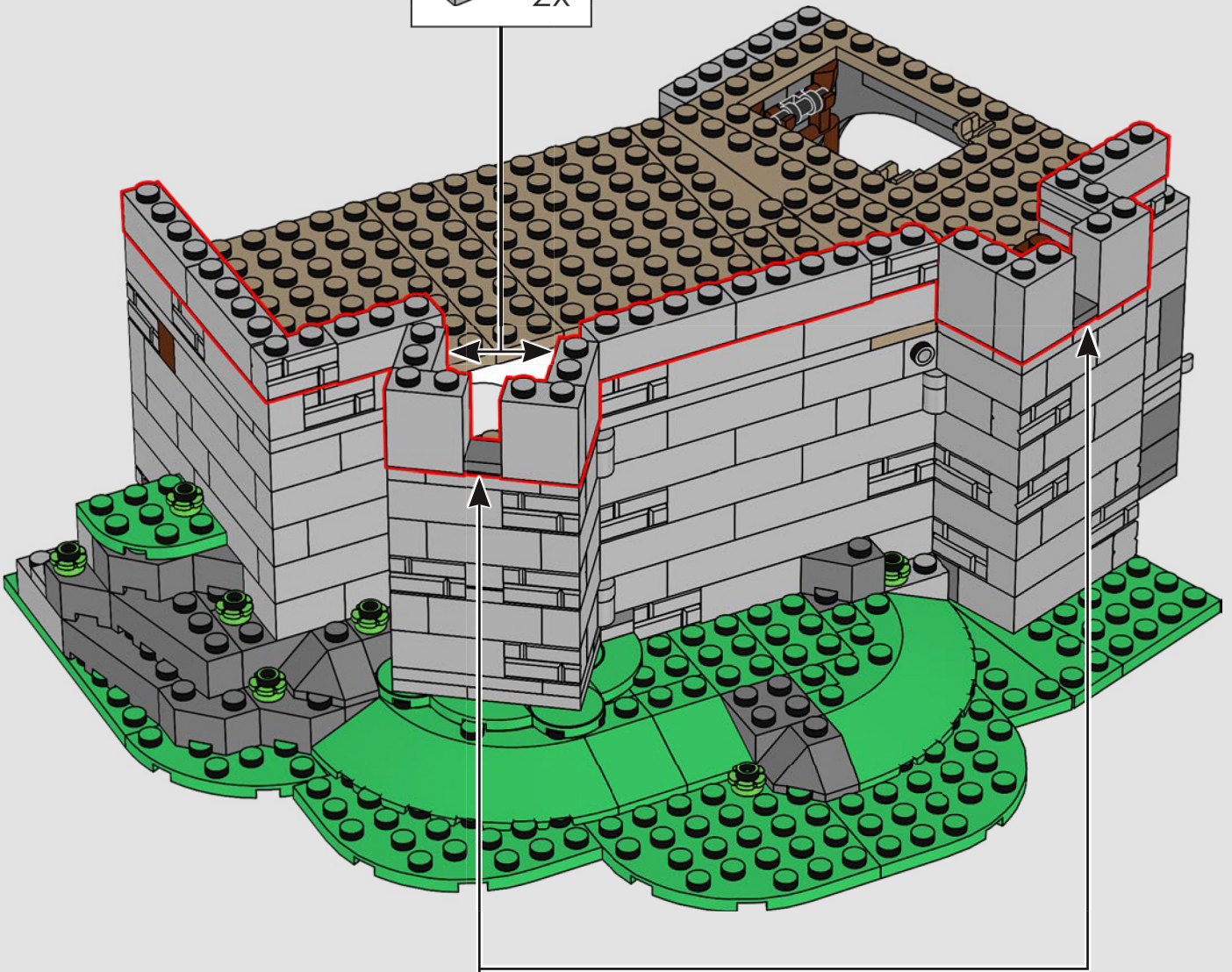
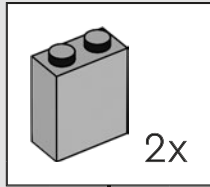

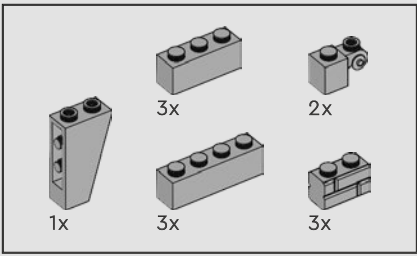

78

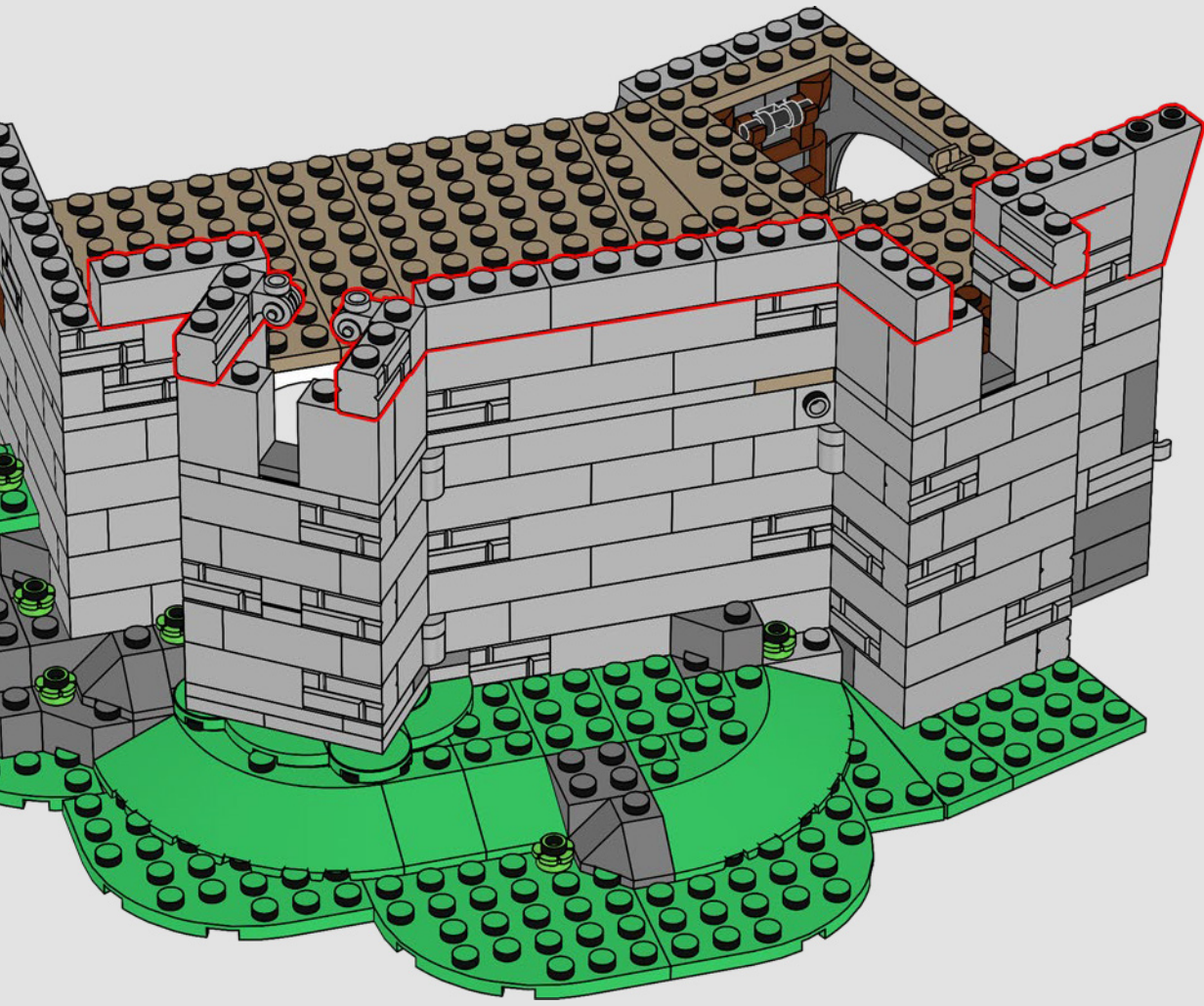

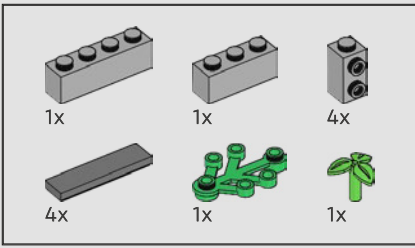

79

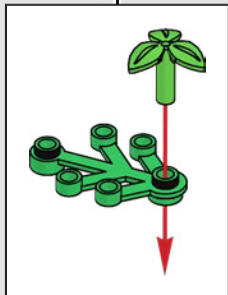
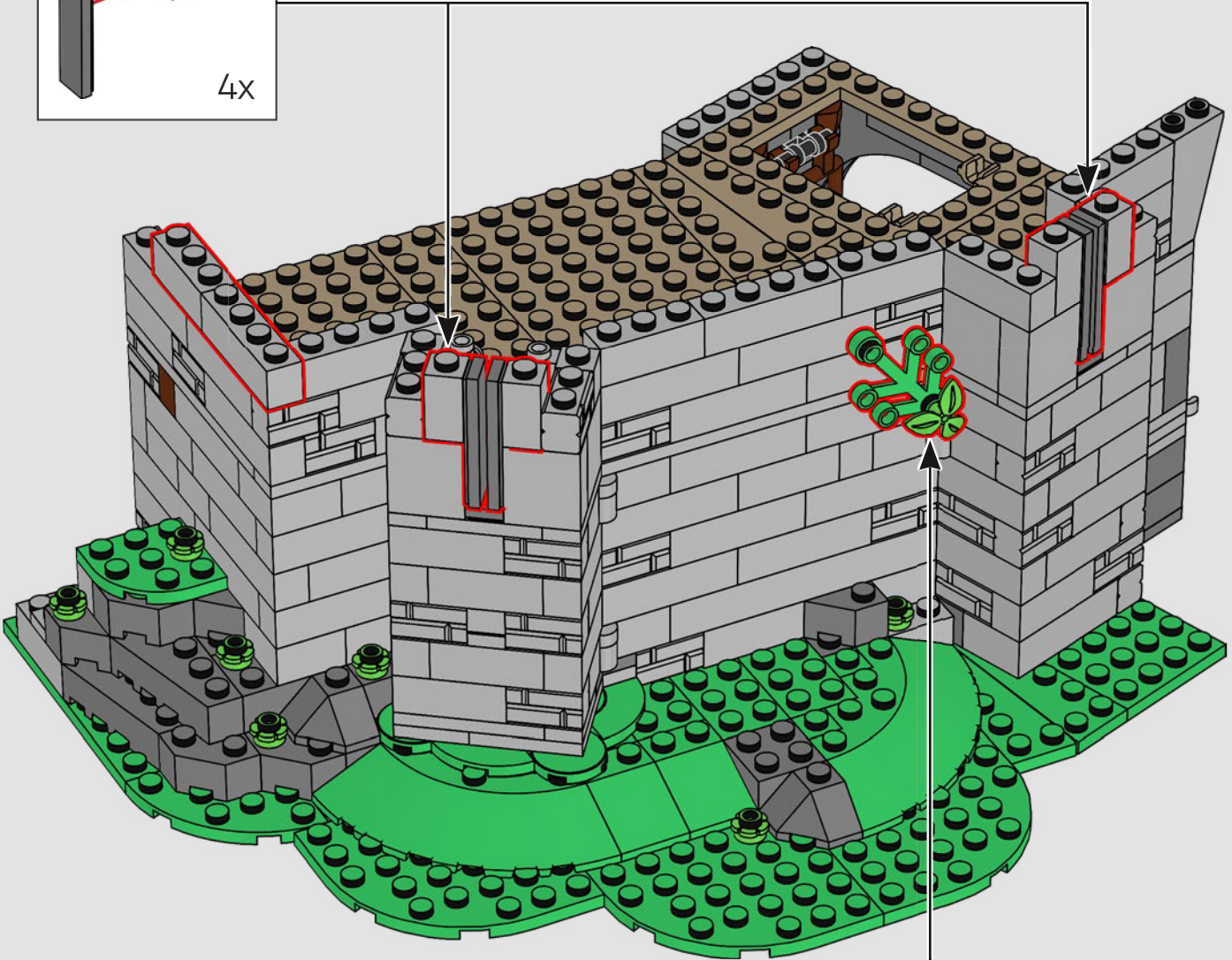
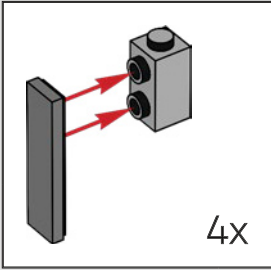

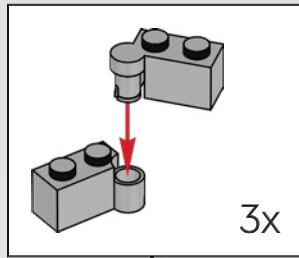
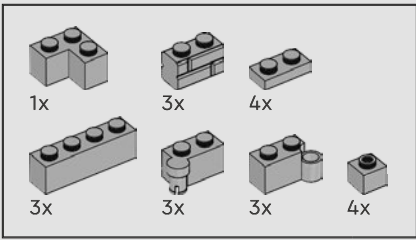

80

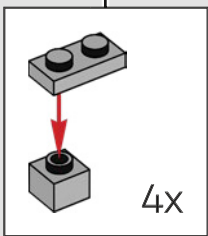

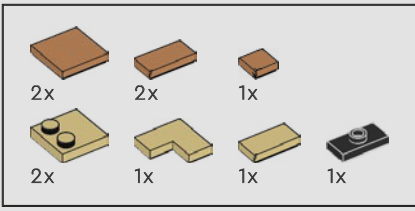

81



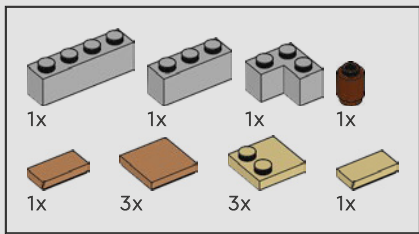

82

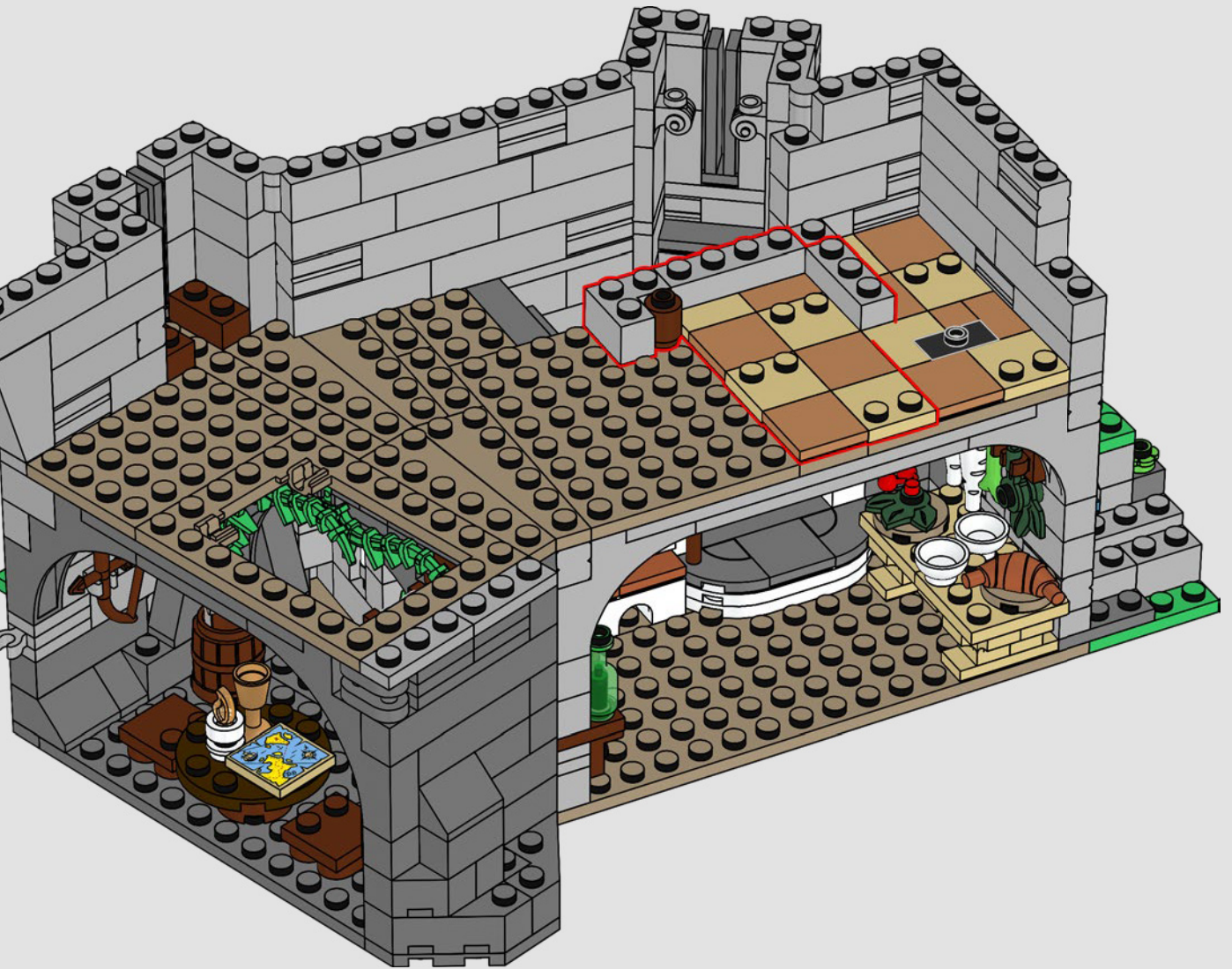

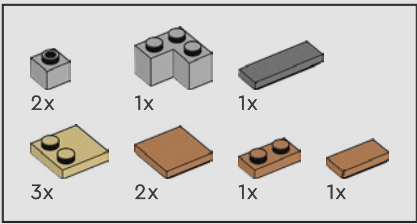

83





*Pourquoi cette entrée est-elle dissimulée ?
La chambre d'en bas doit-elle être
cachée à Madame ?*

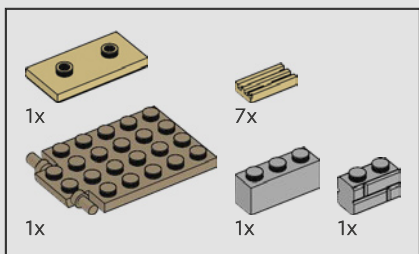

84

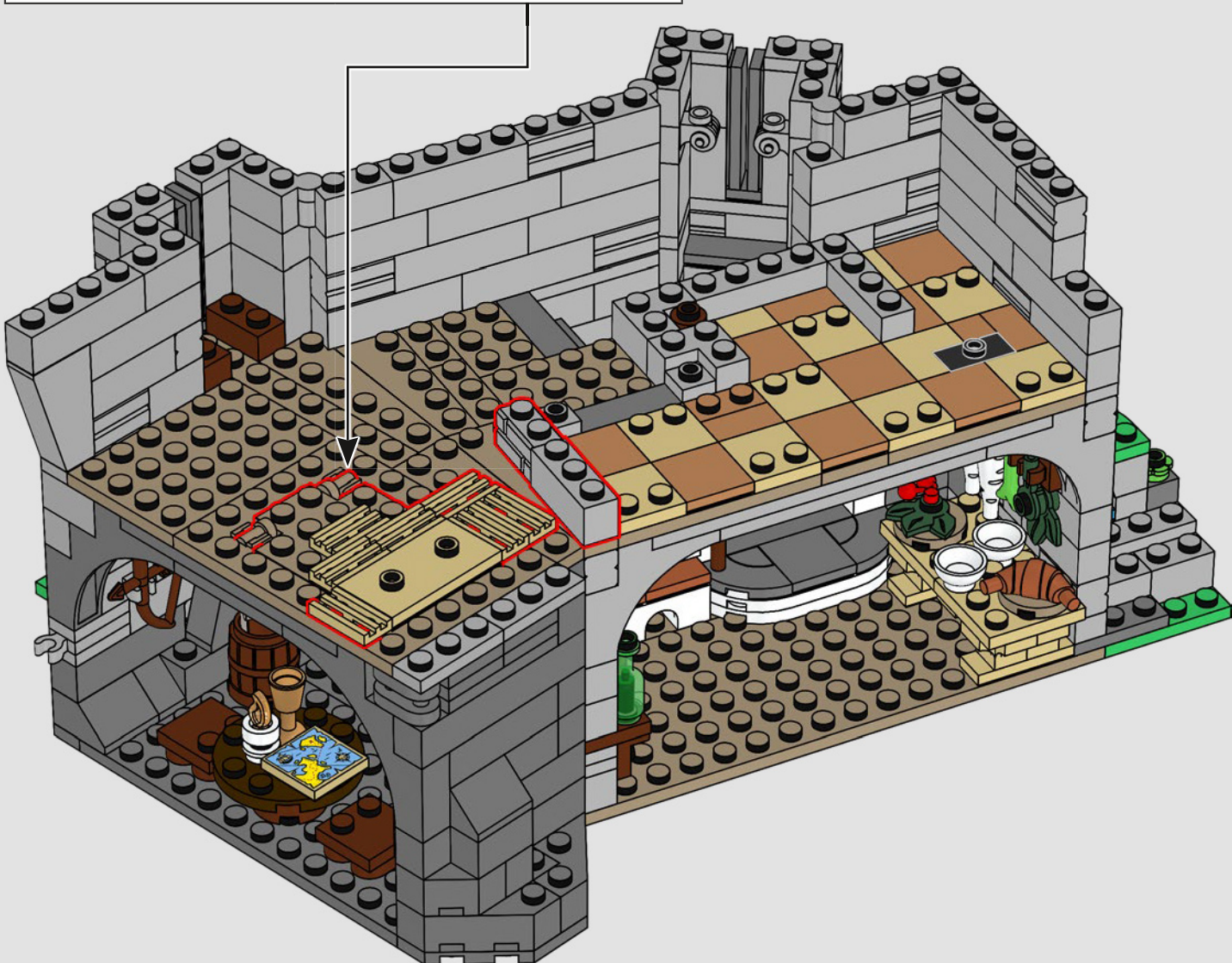
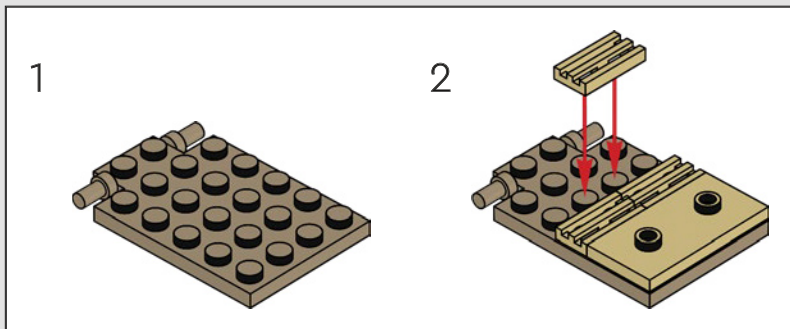

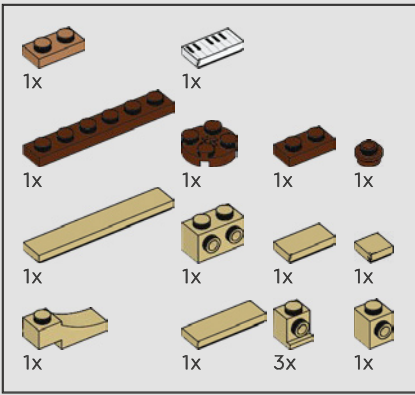

85

1

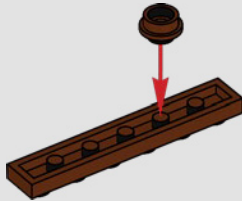

2

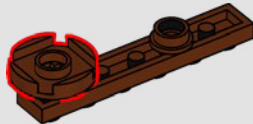

3

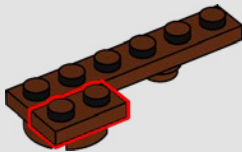

4

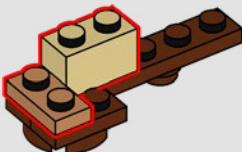

5

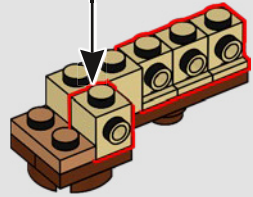
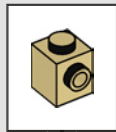

6

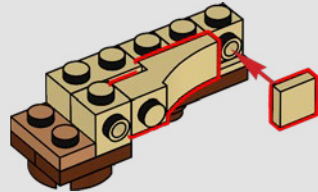

7

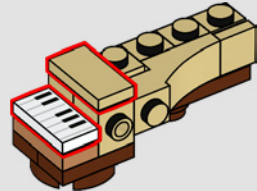

8

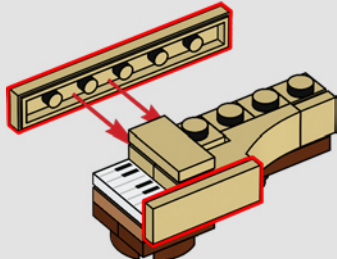



Écoutez, ne serait-ce pas le son mélodieux
d'un clavecin ? La musique moderne :
quelle merveille !

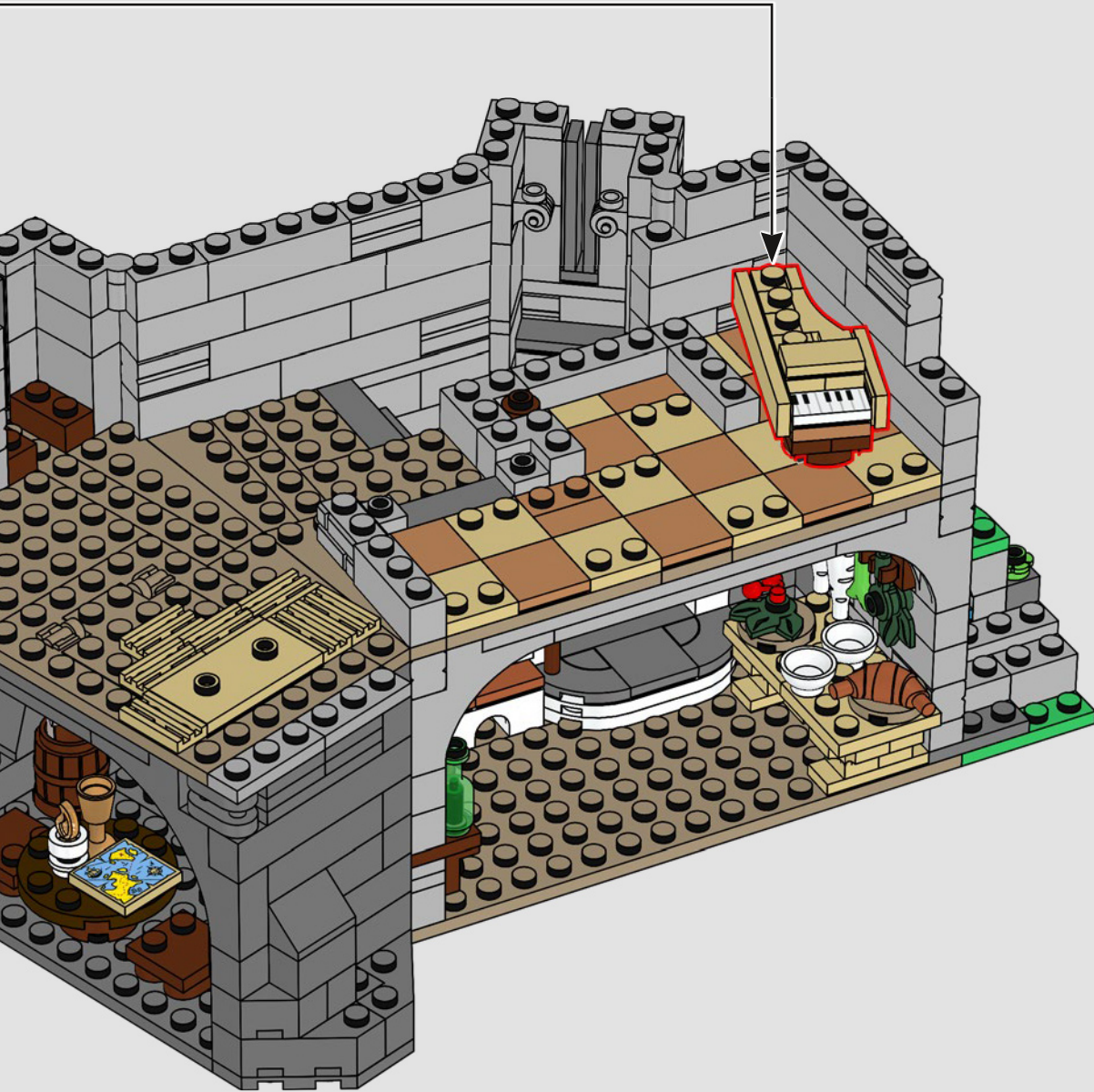

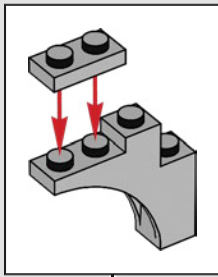
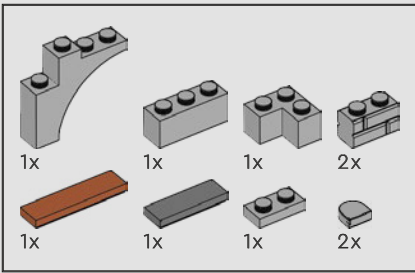

86

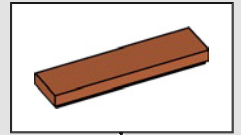
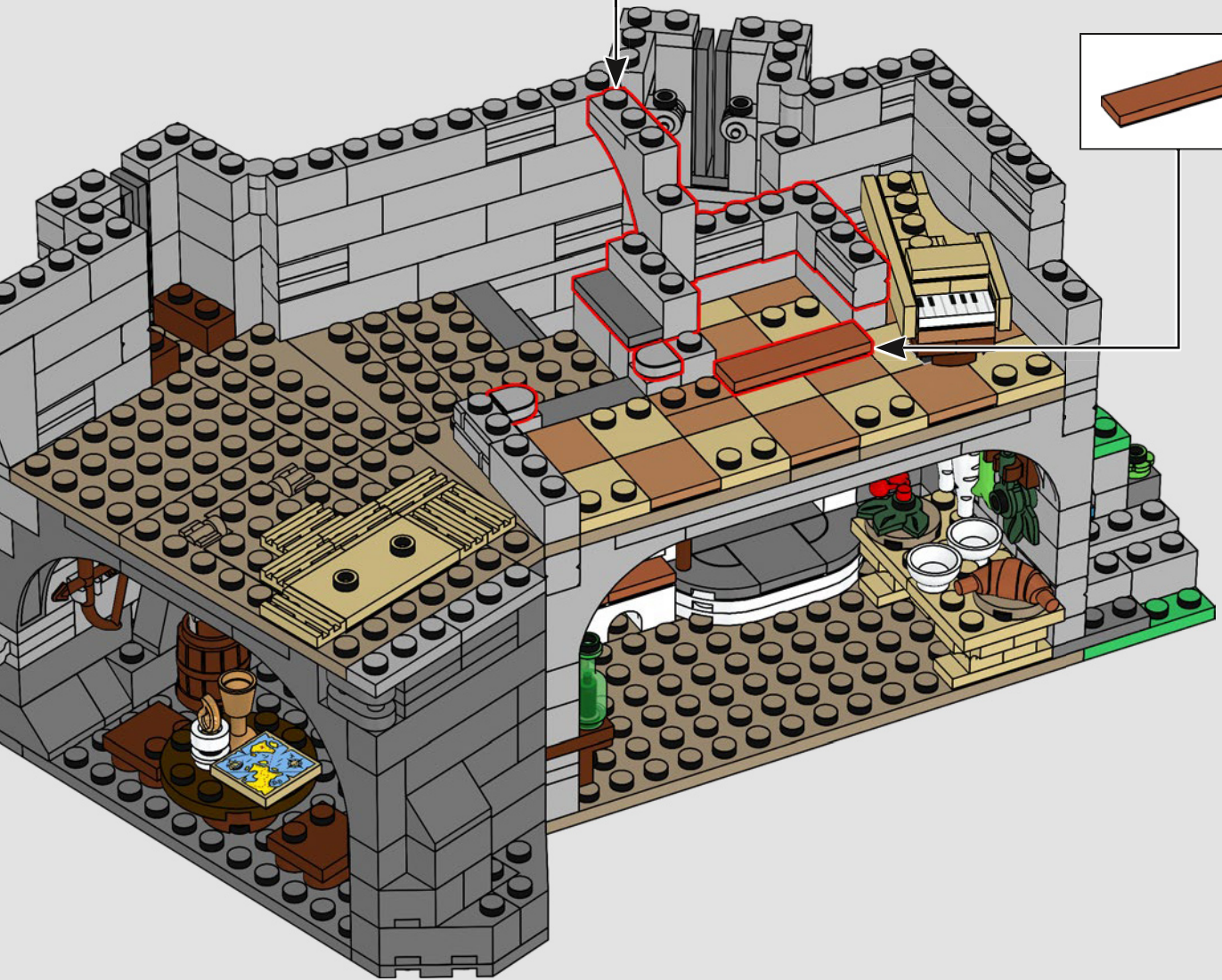

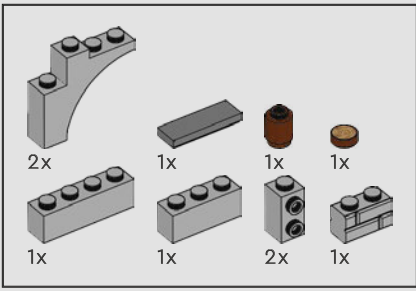

87

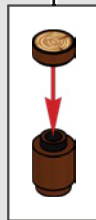
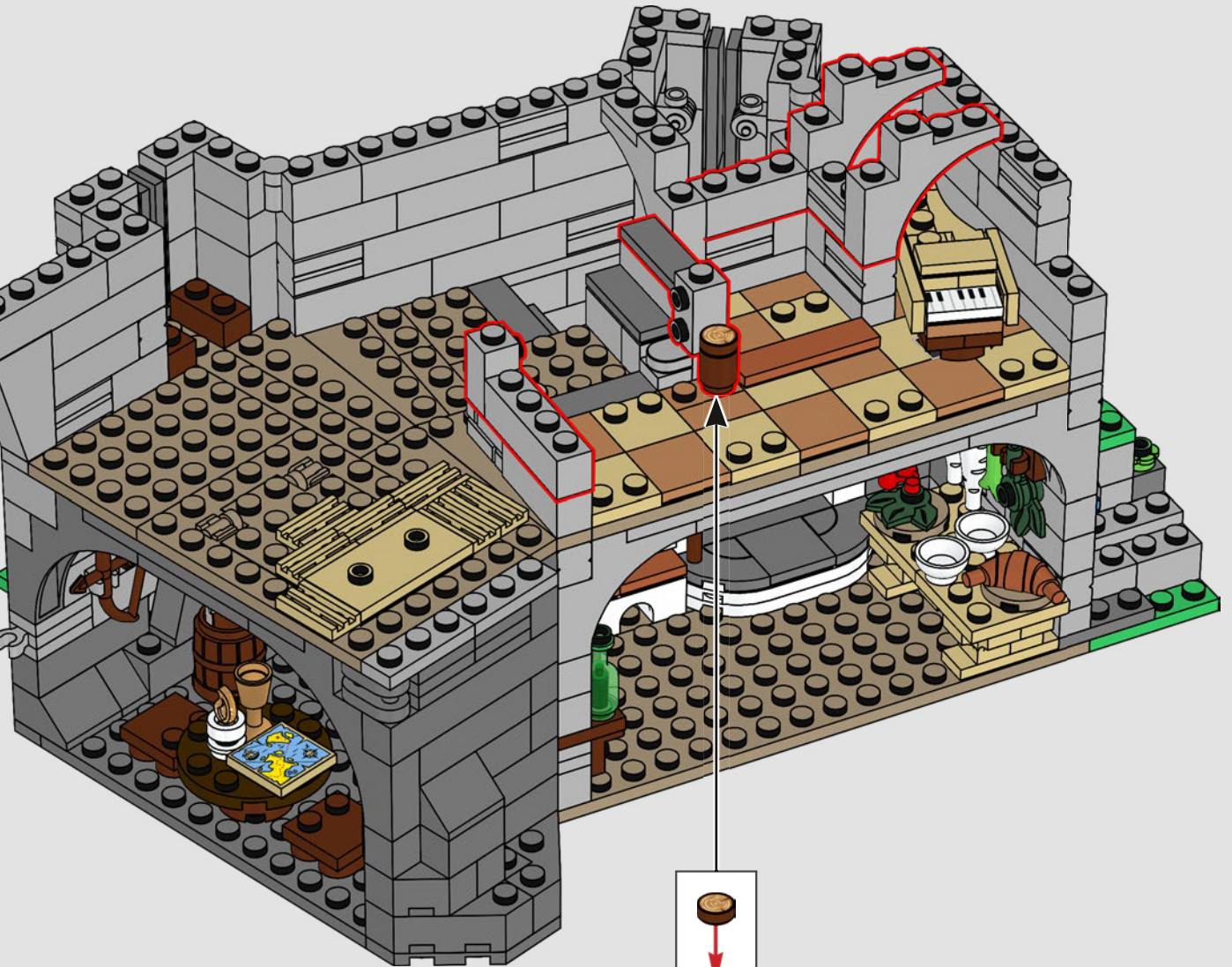

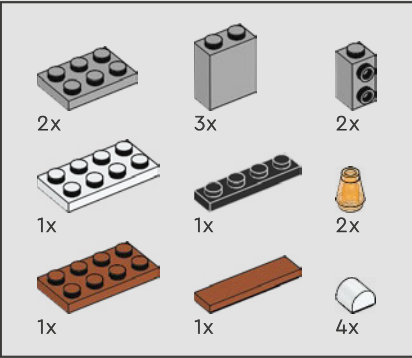
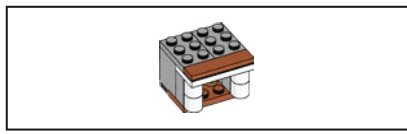

88

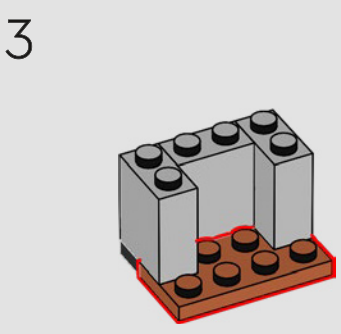
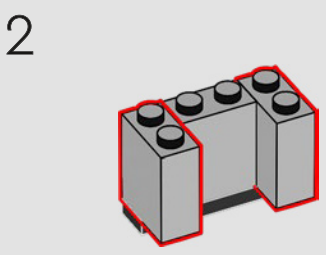
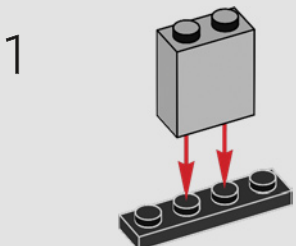

4

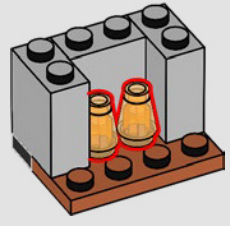

5

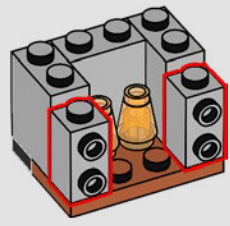

6

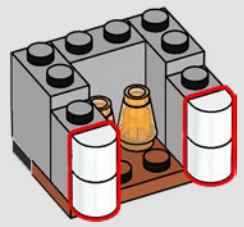

7

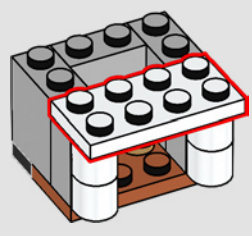

8

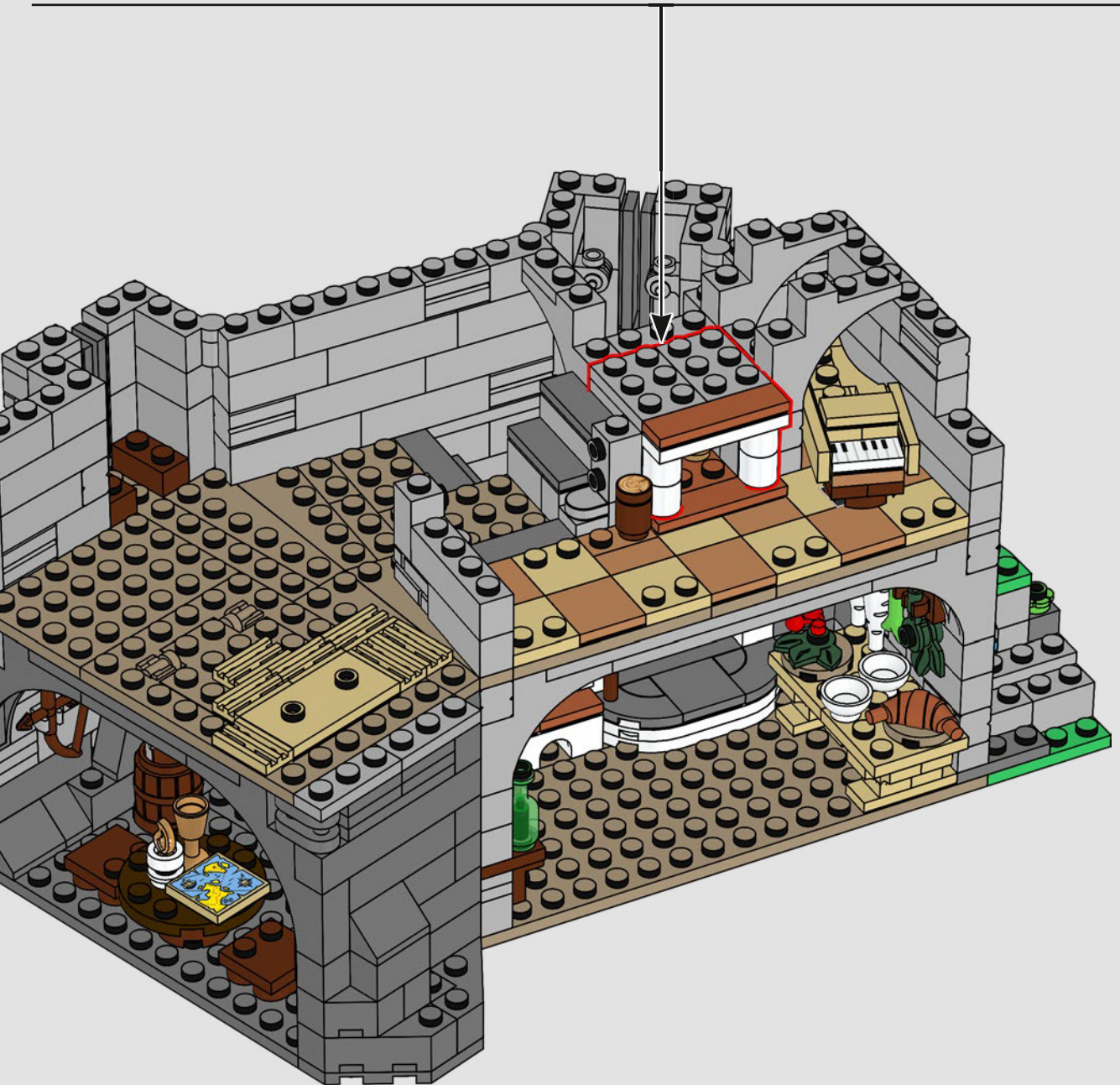
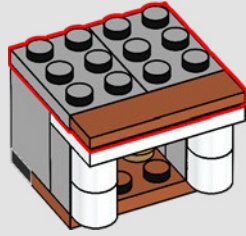

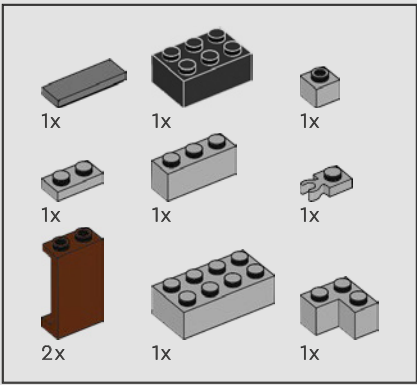

89

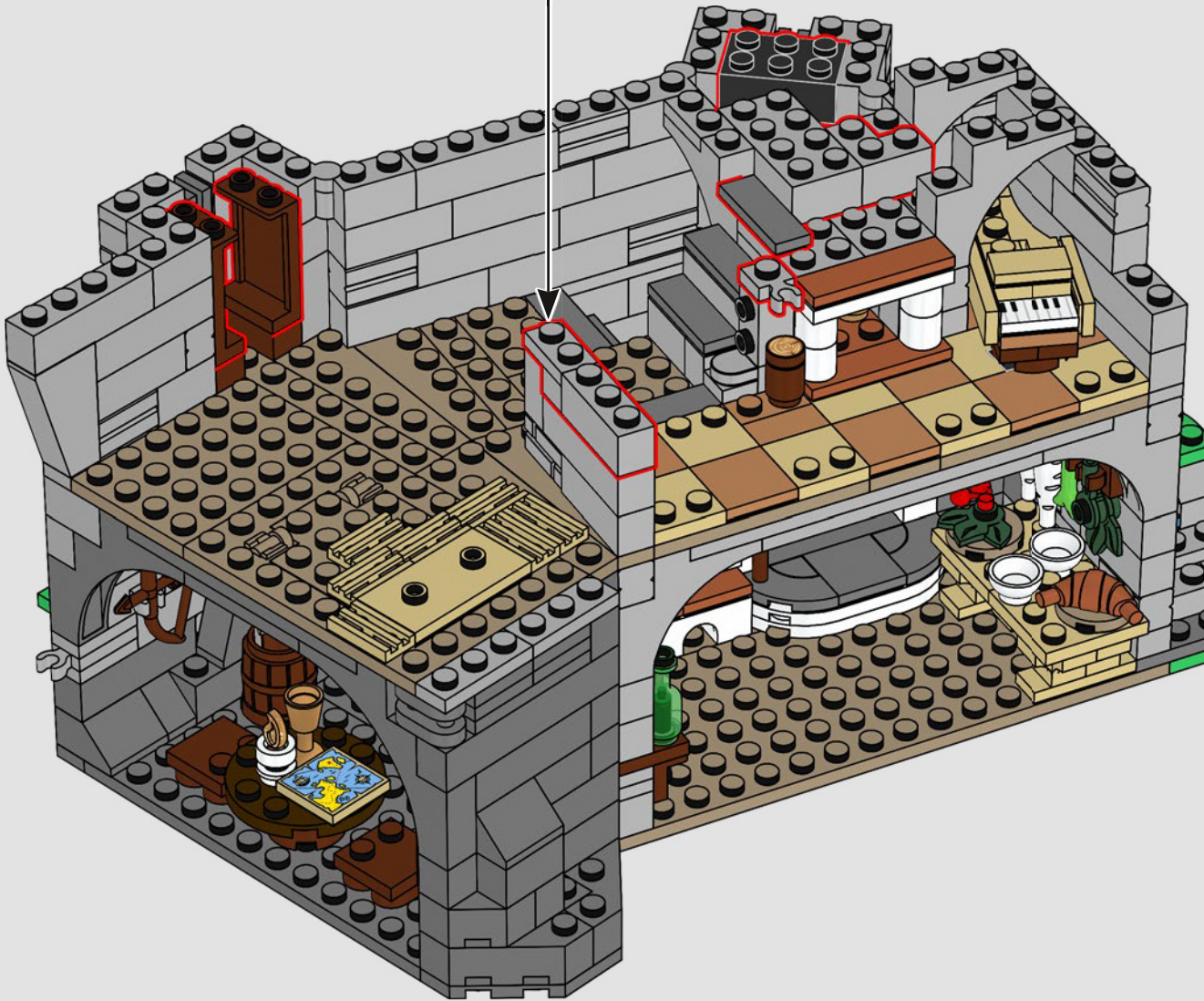
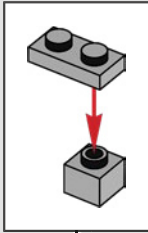

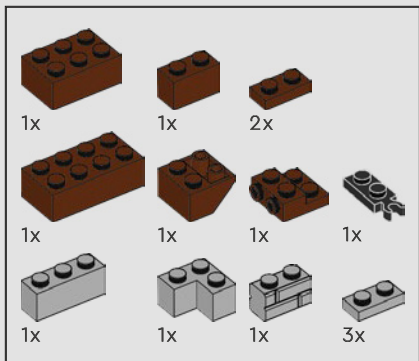

90

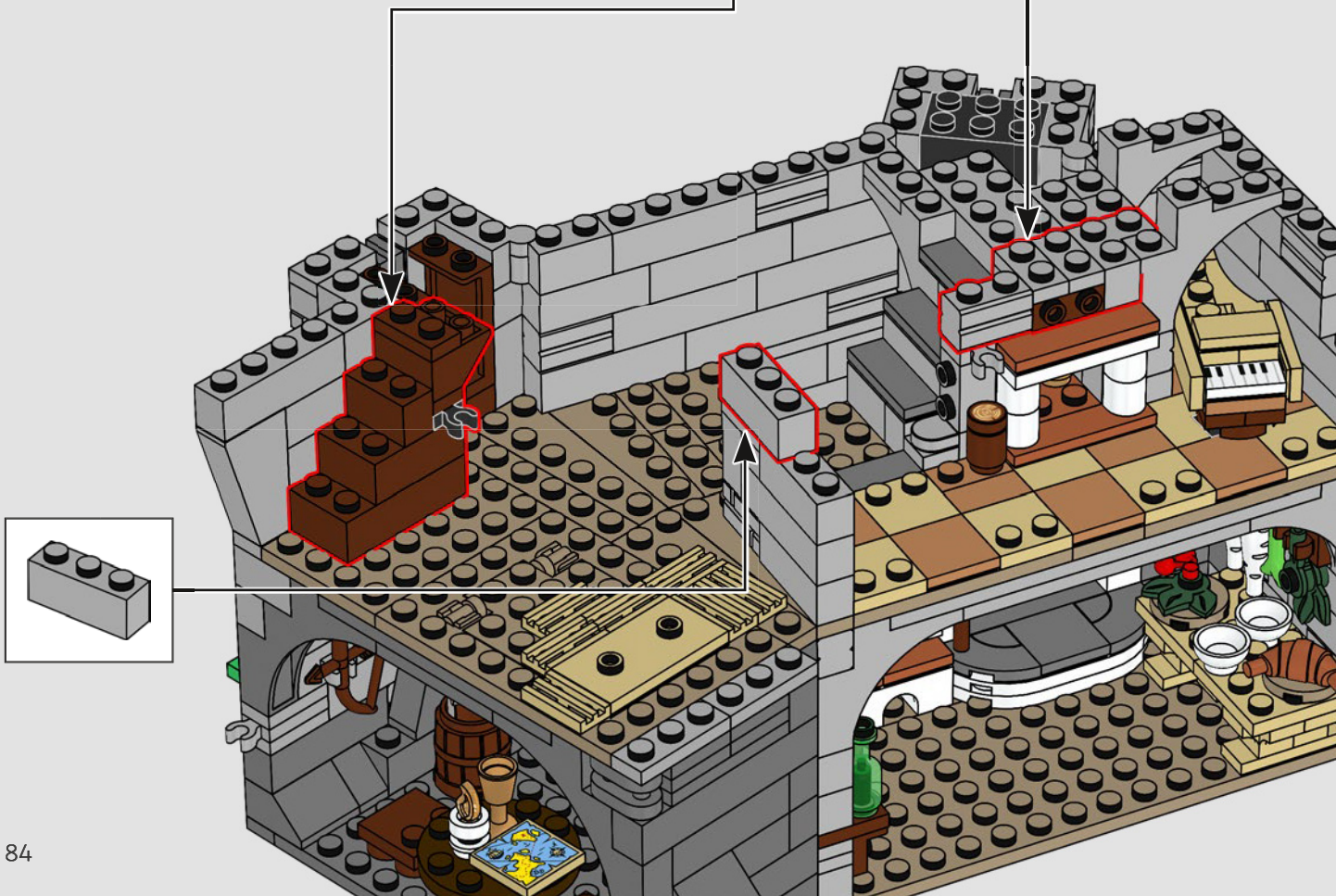
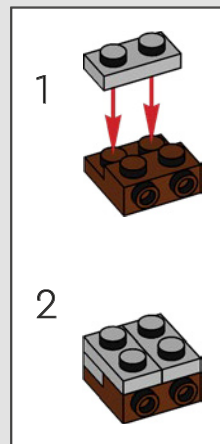
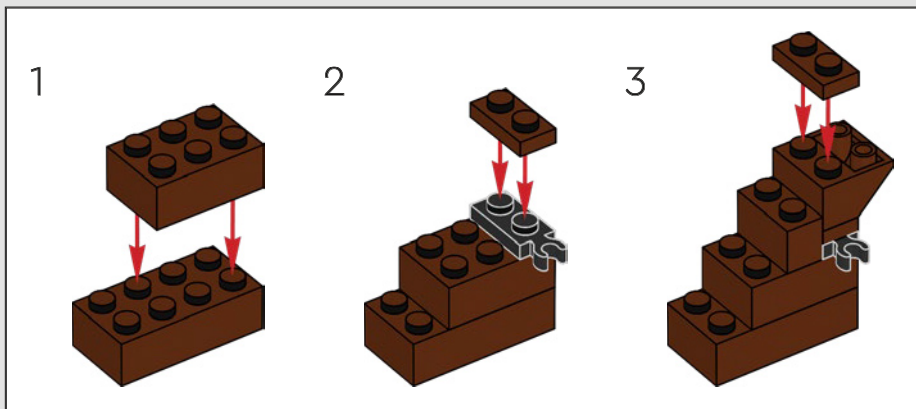

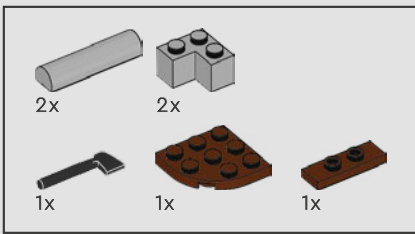

91

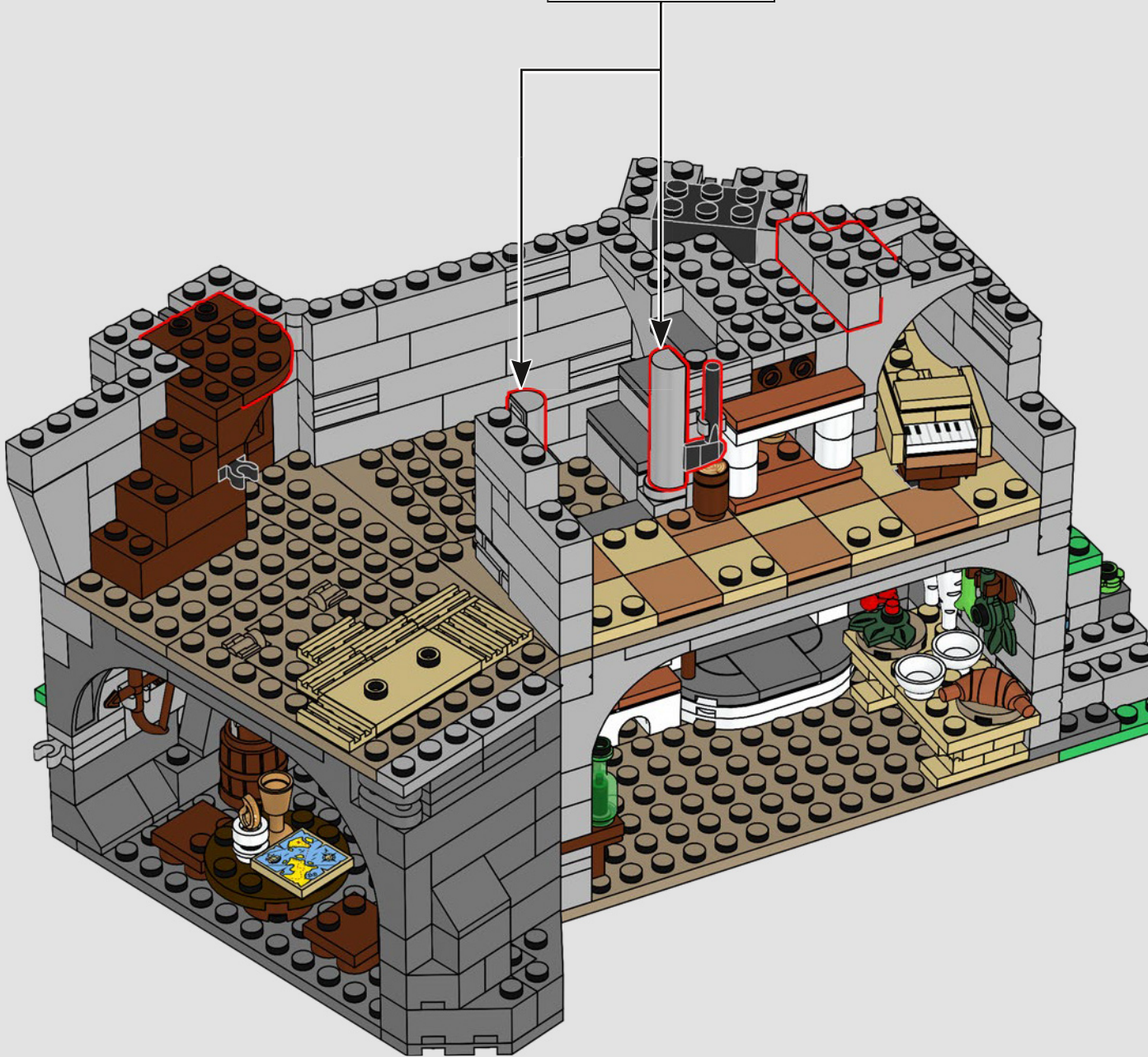
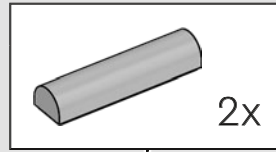

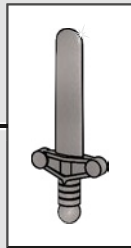
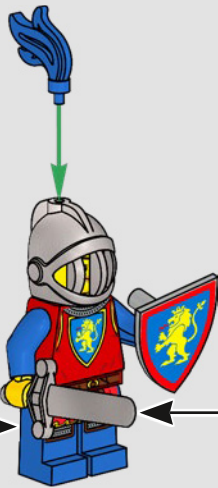
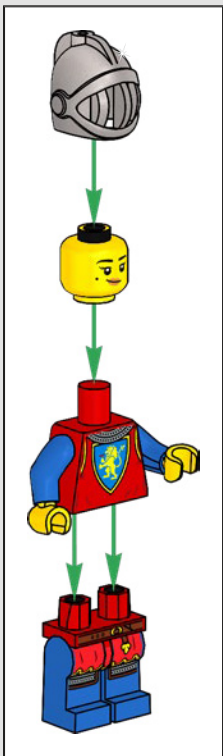

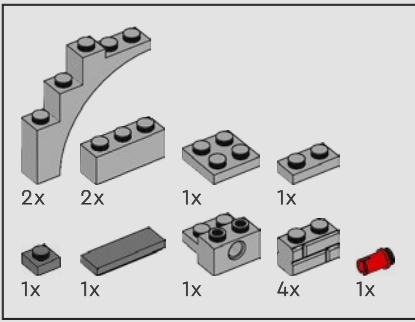

92

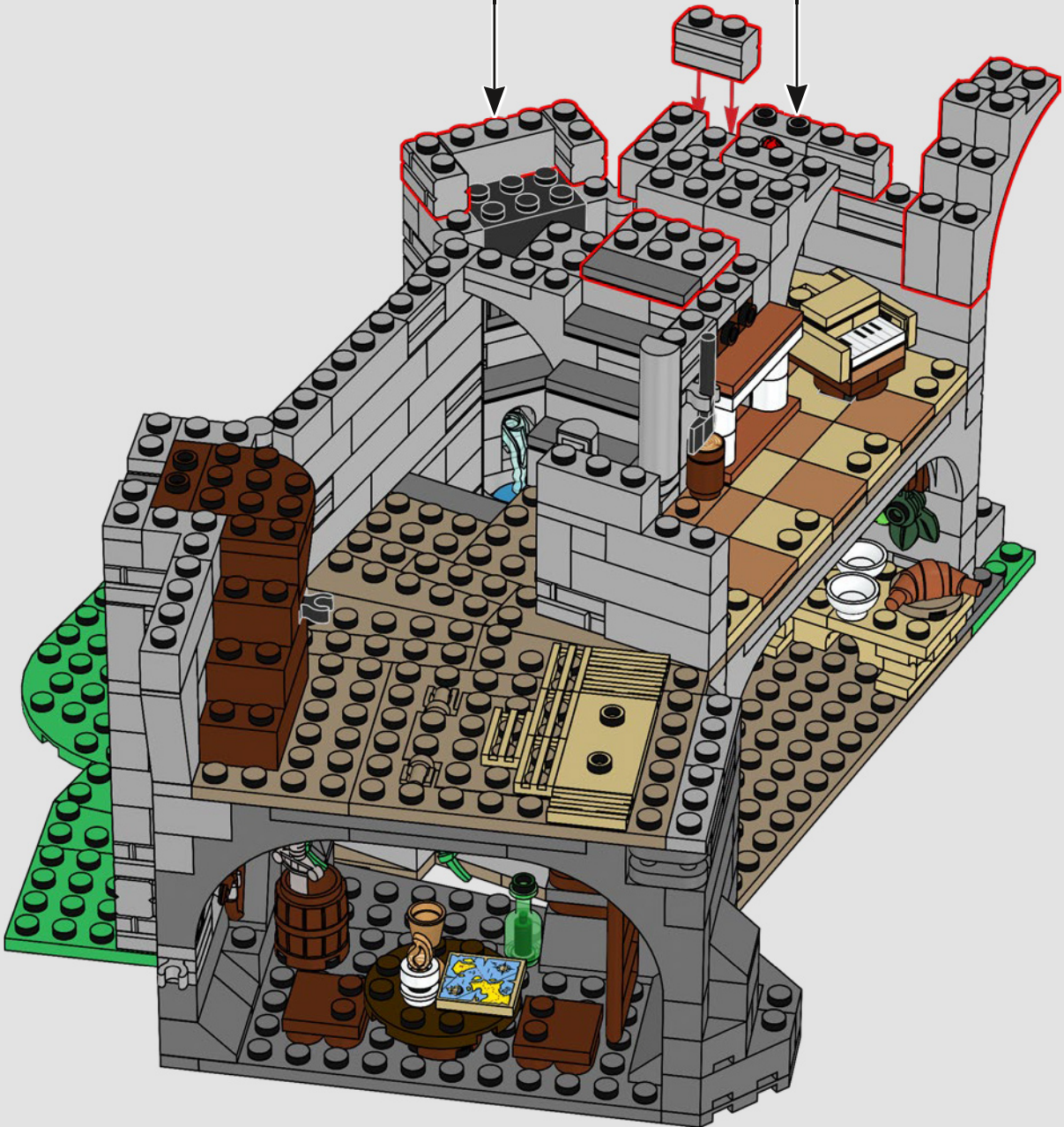
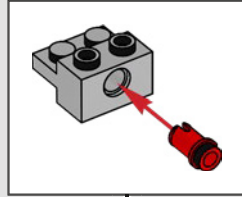
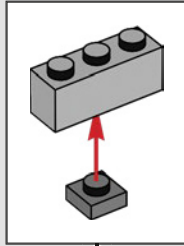

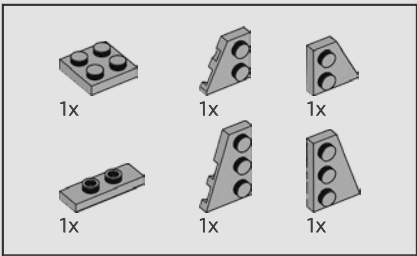

93

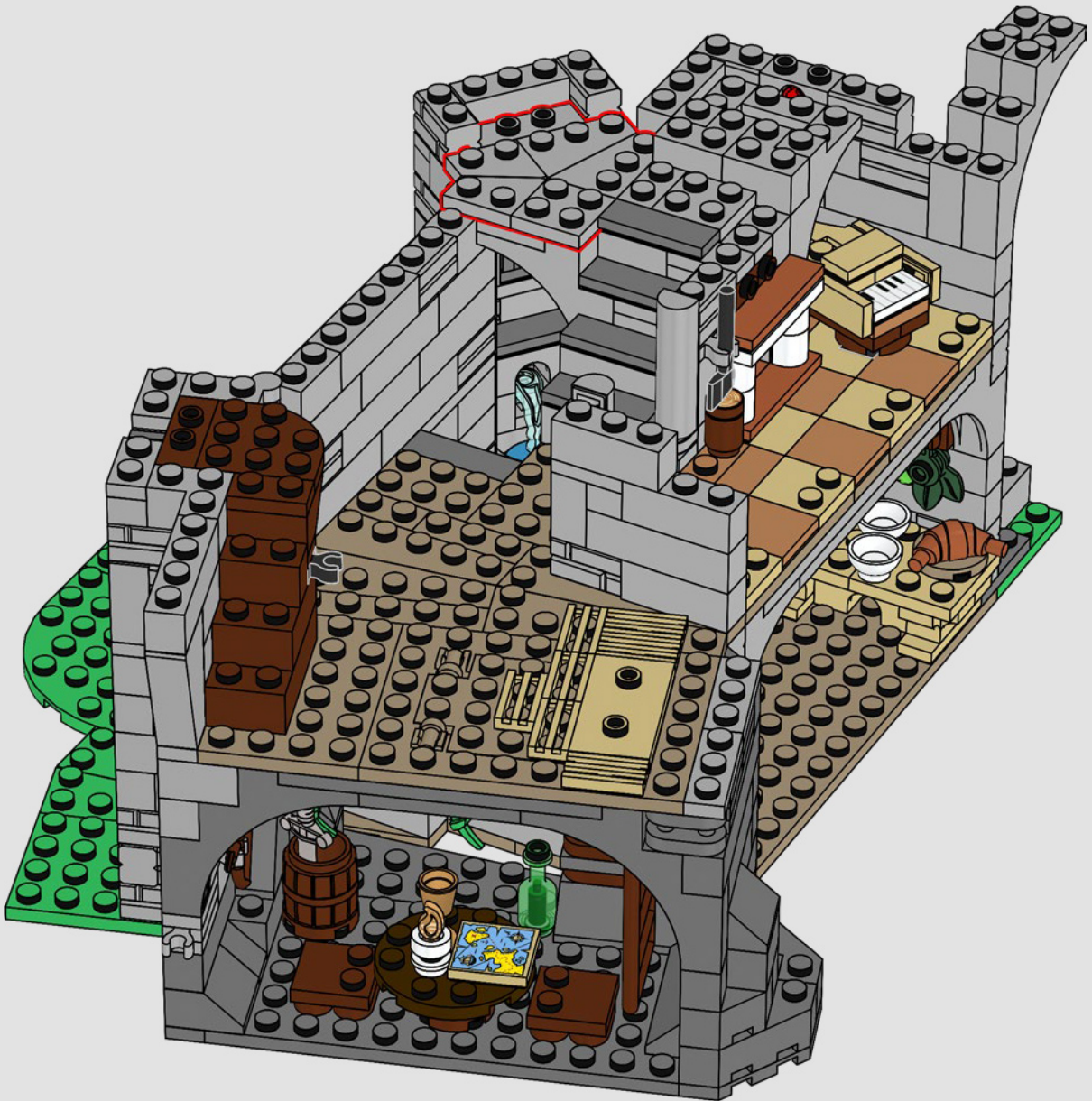

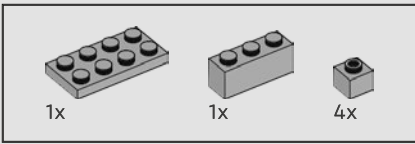

94

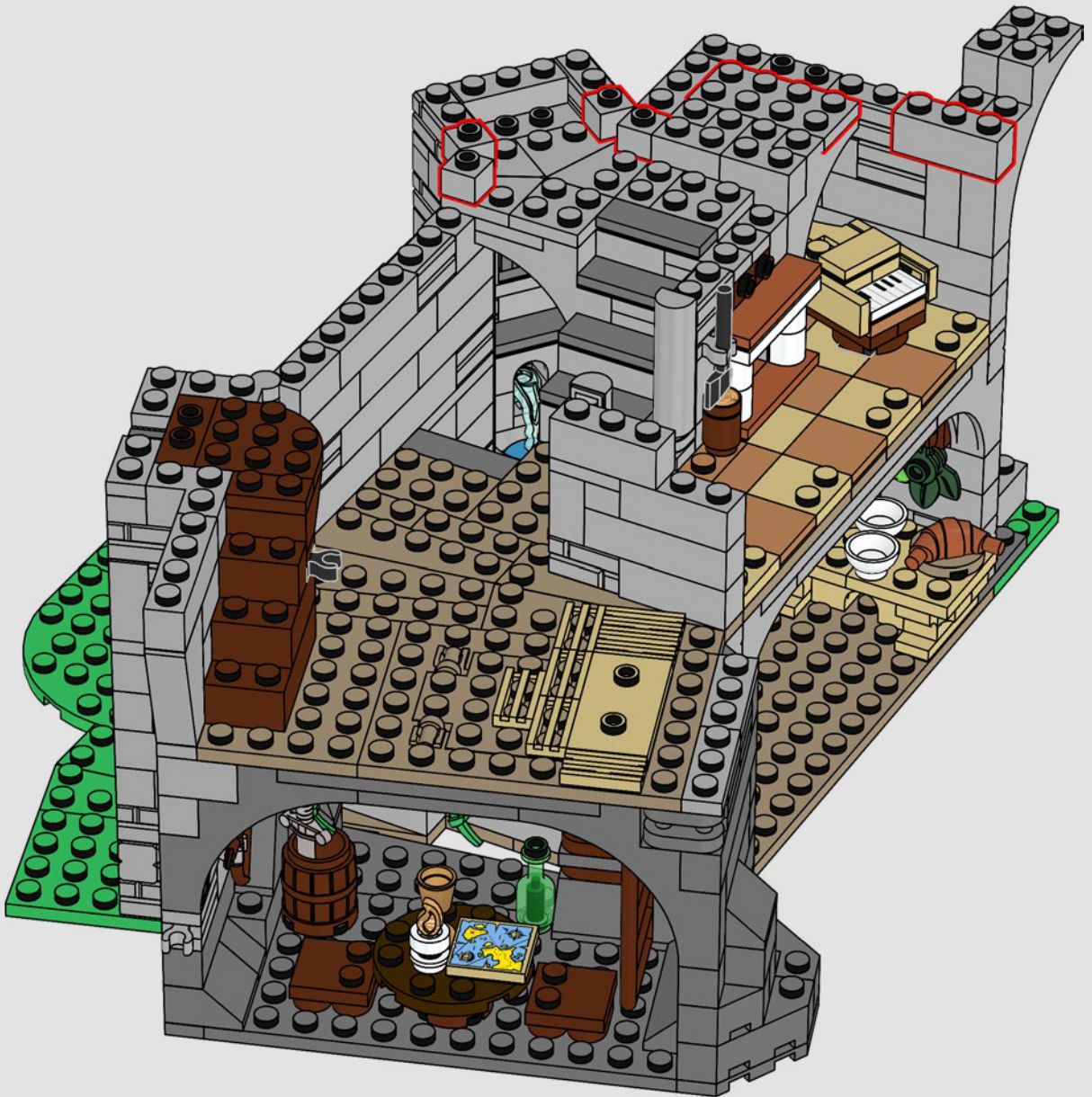

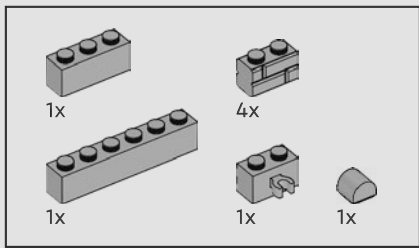

95

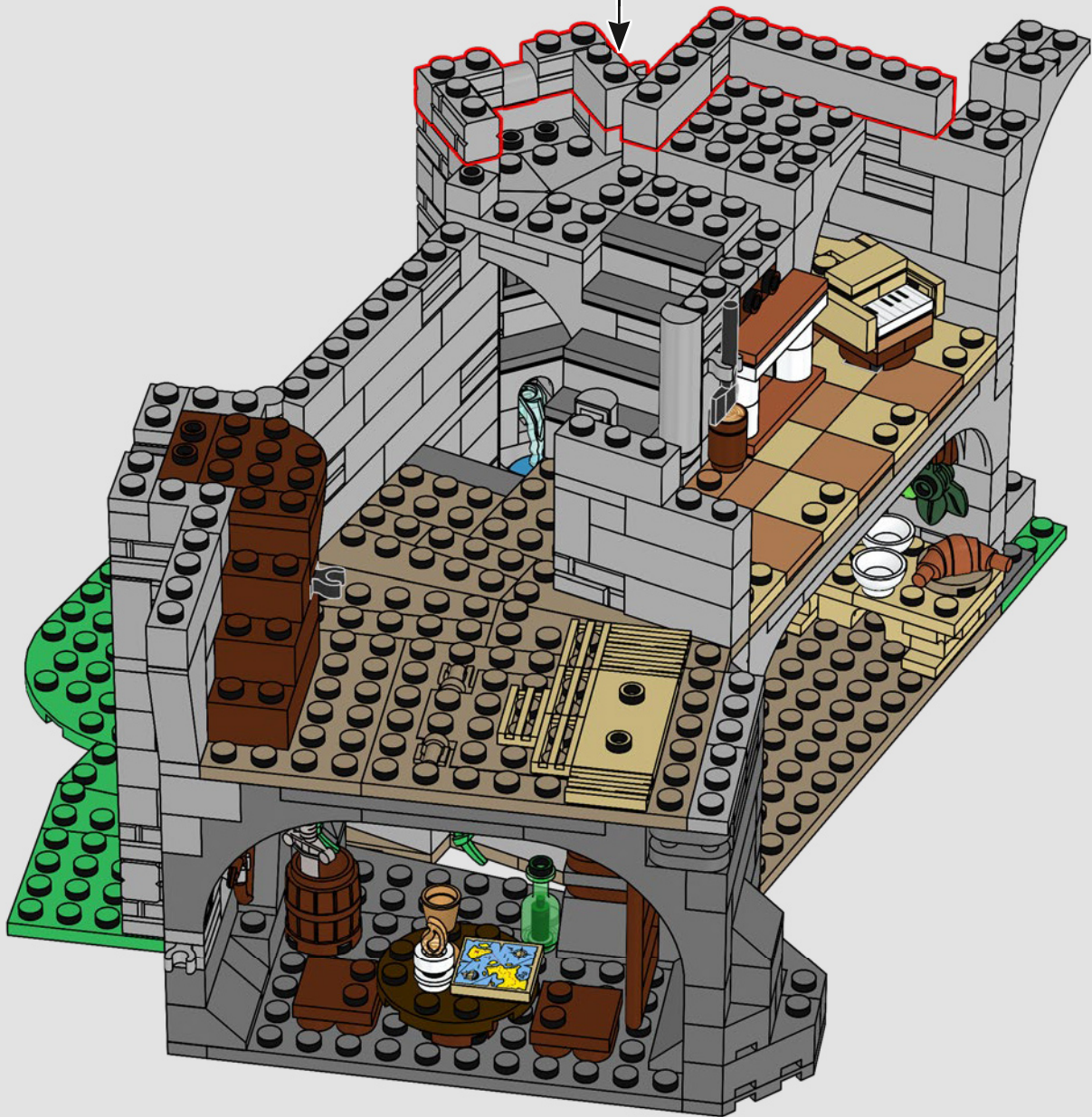
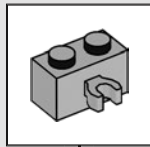

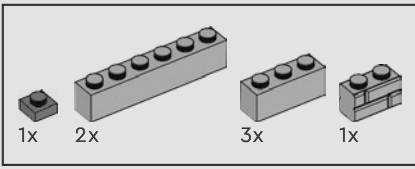

96

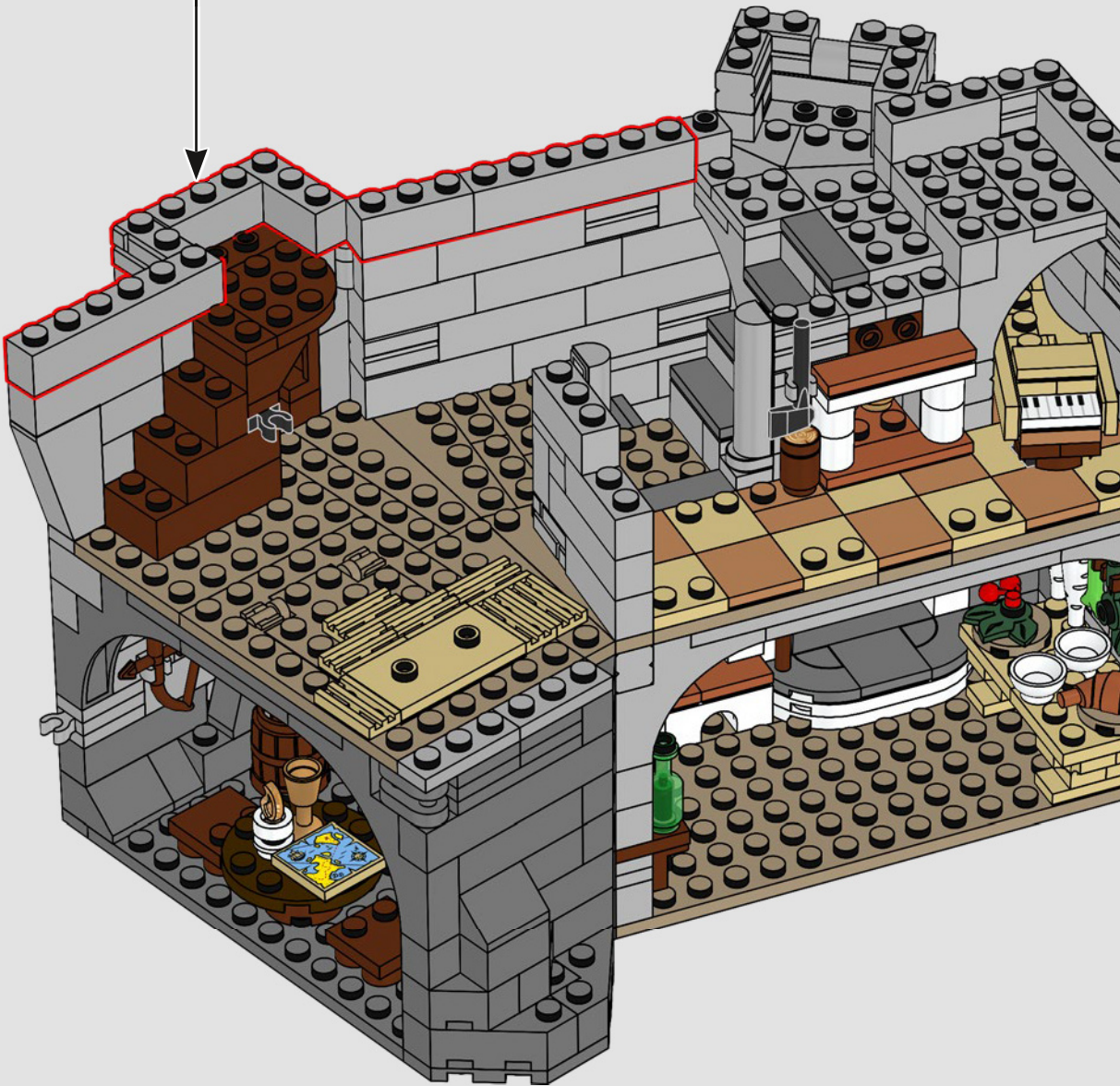
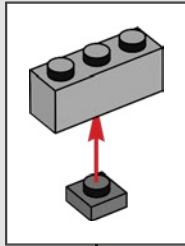

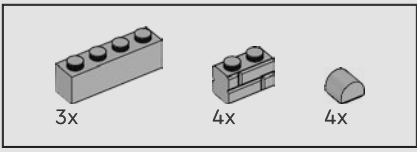

97





Le créneau au sommet de cette courtine est majestueux !

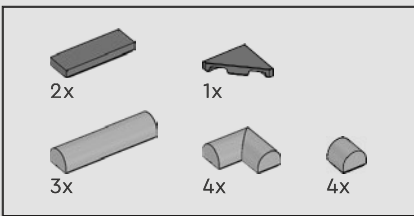

98



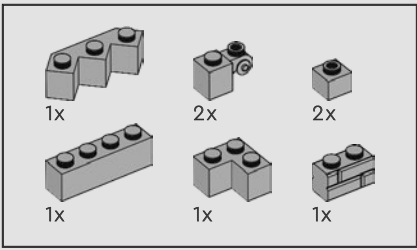

99

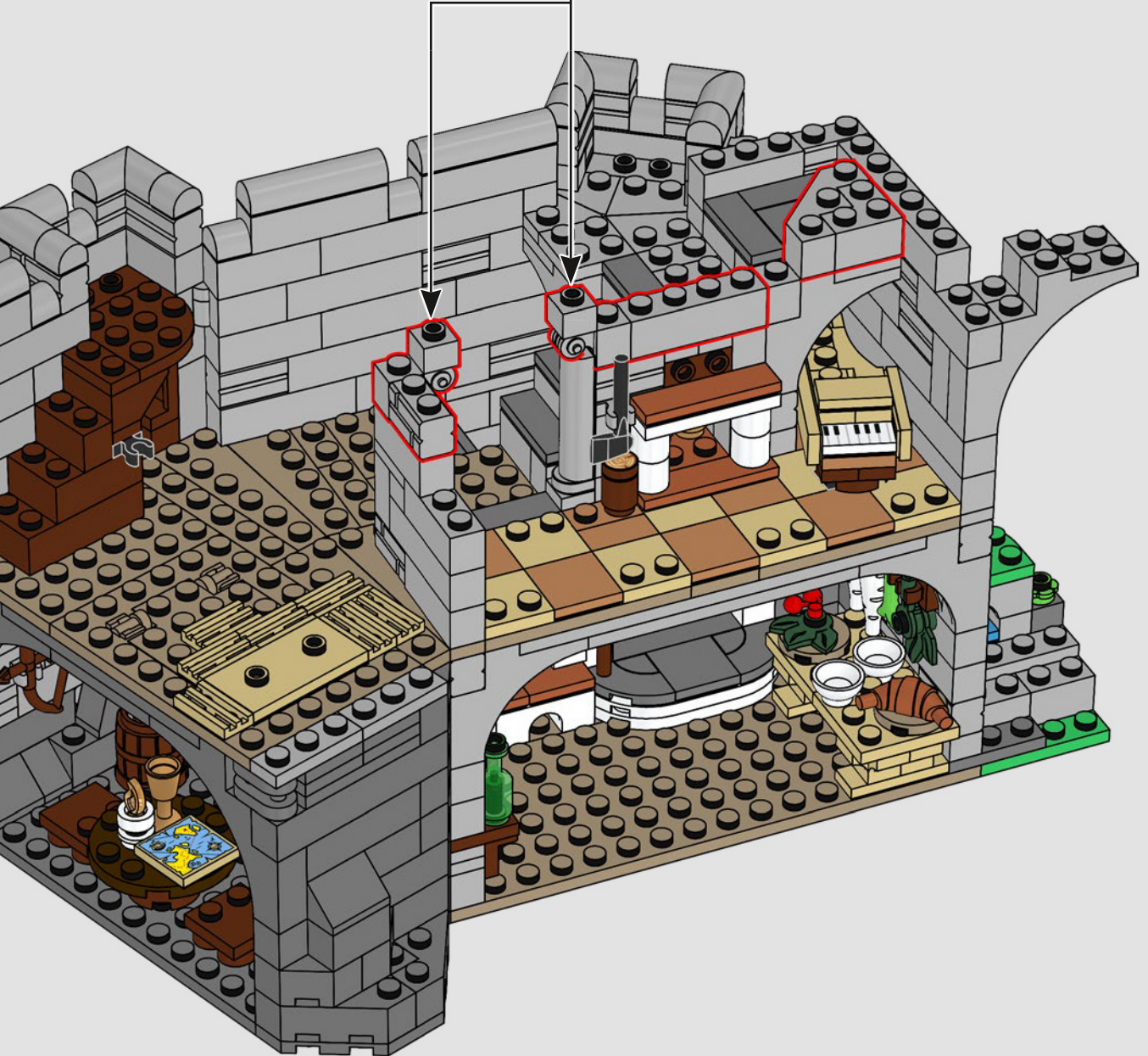
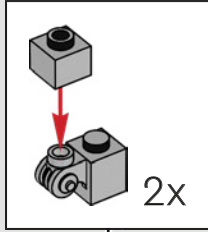

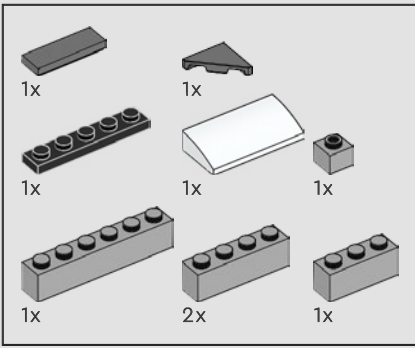

100

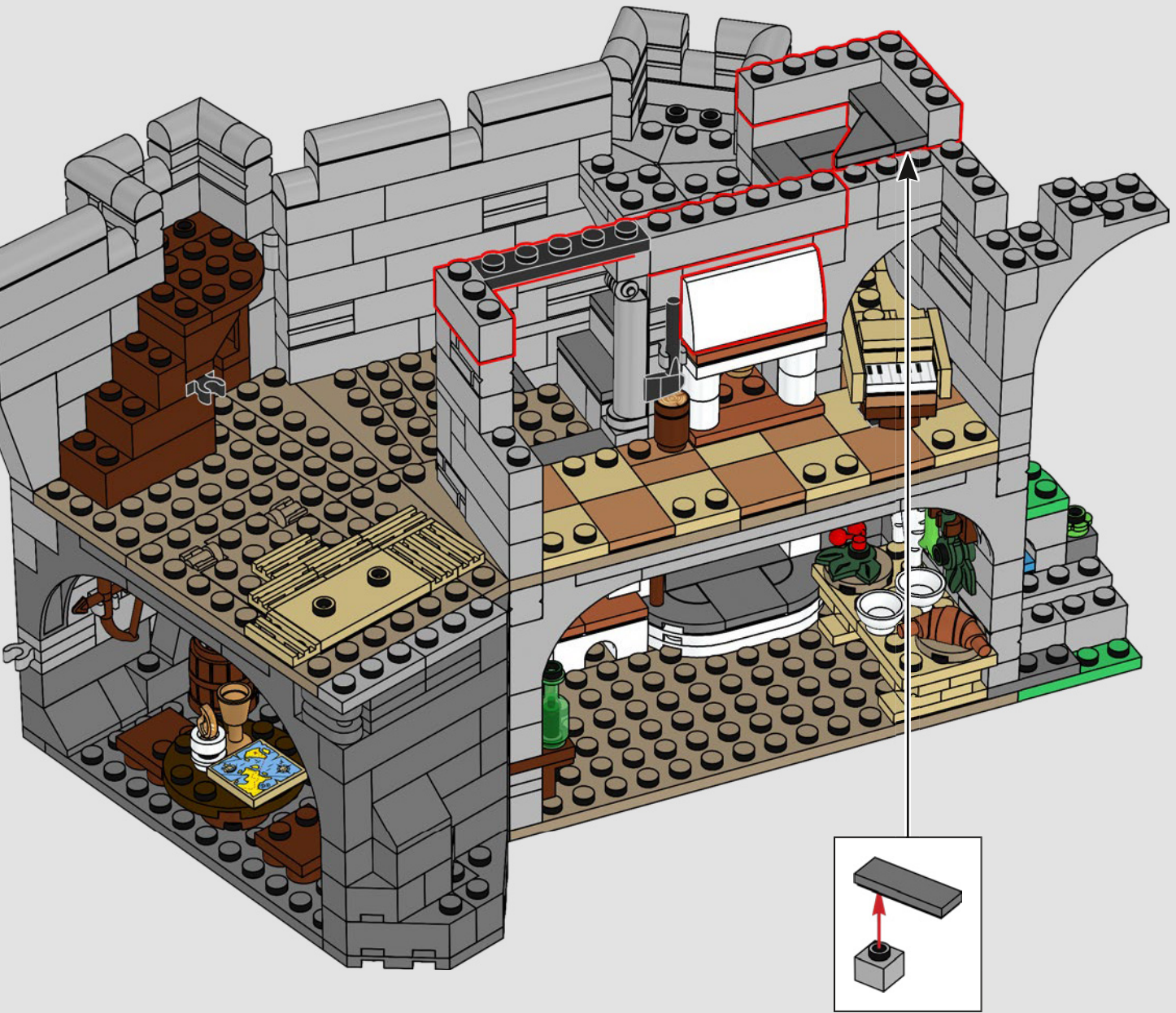

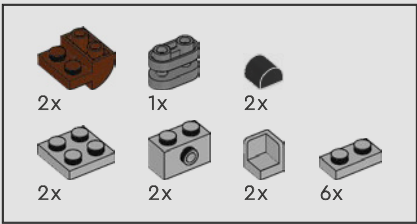

101

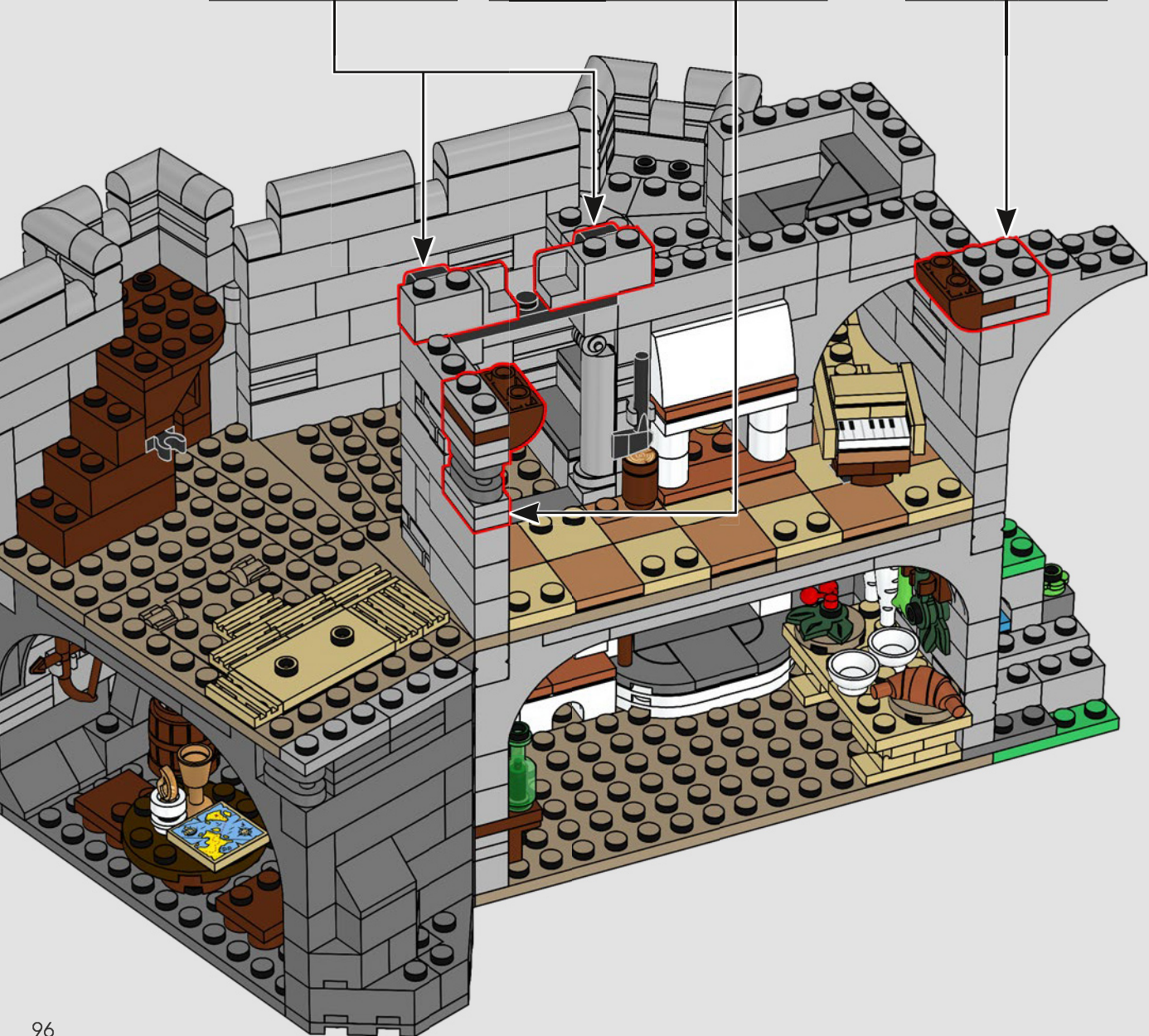
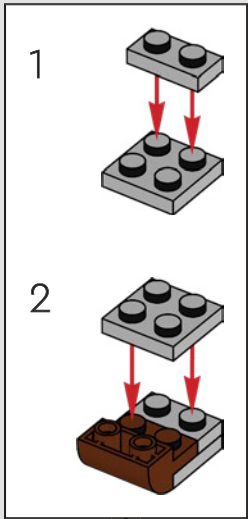
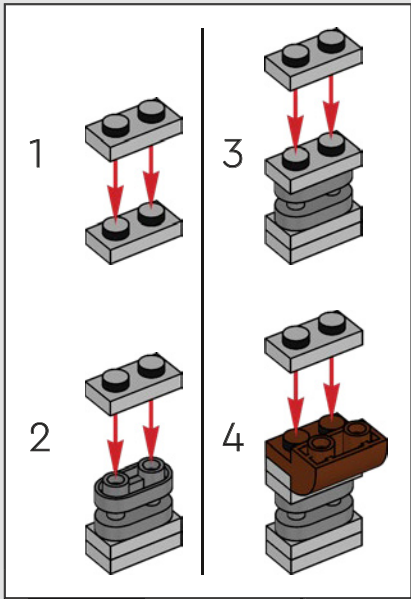
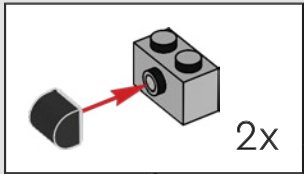

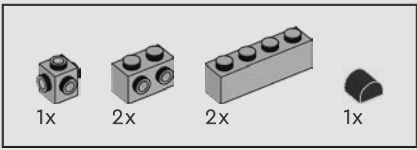

102

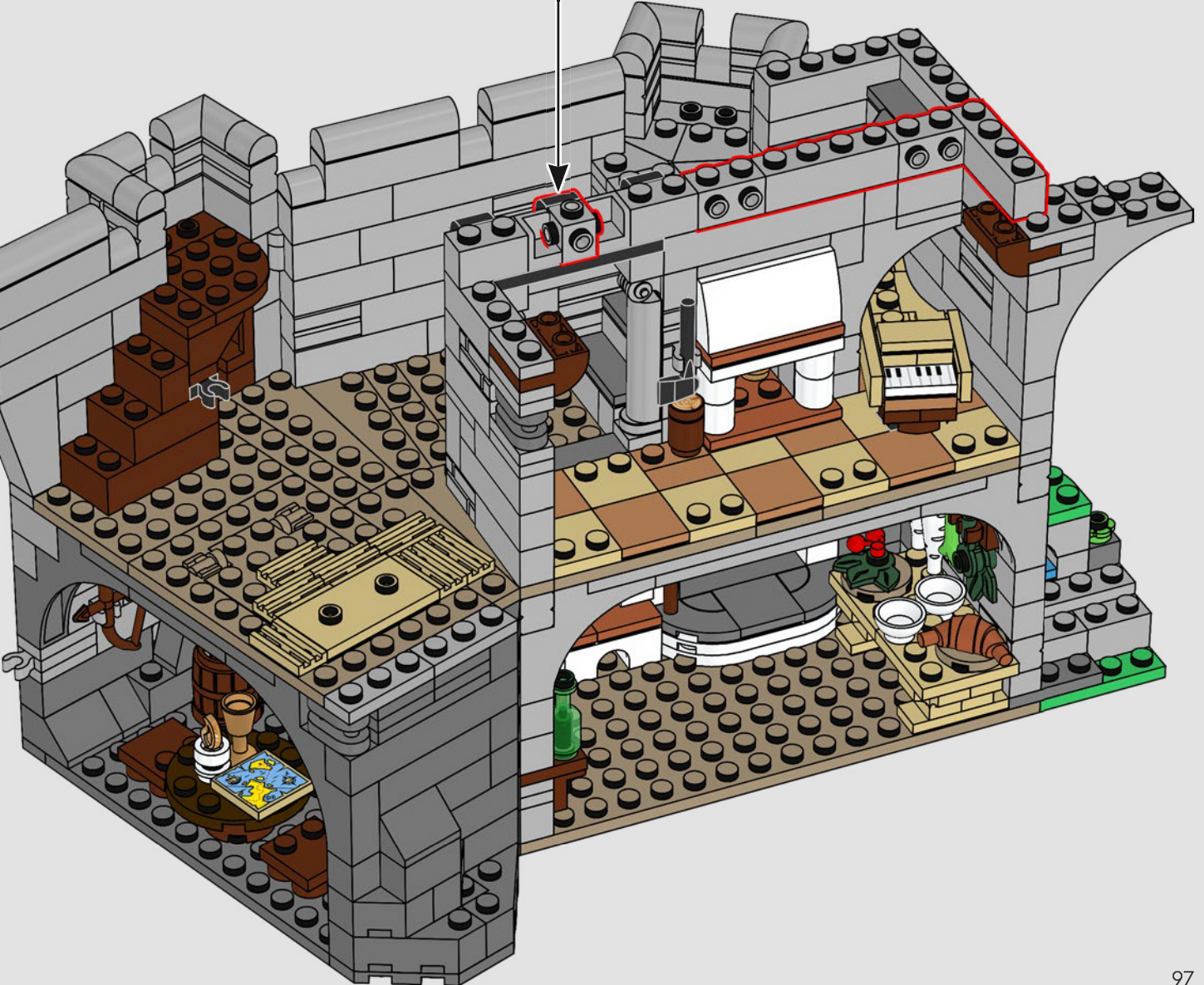
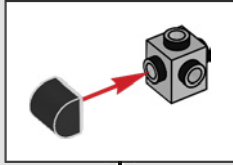

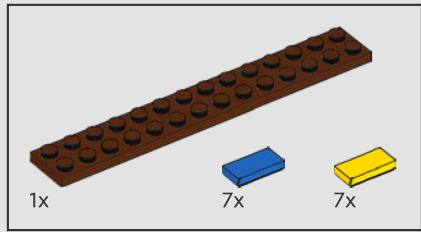

103

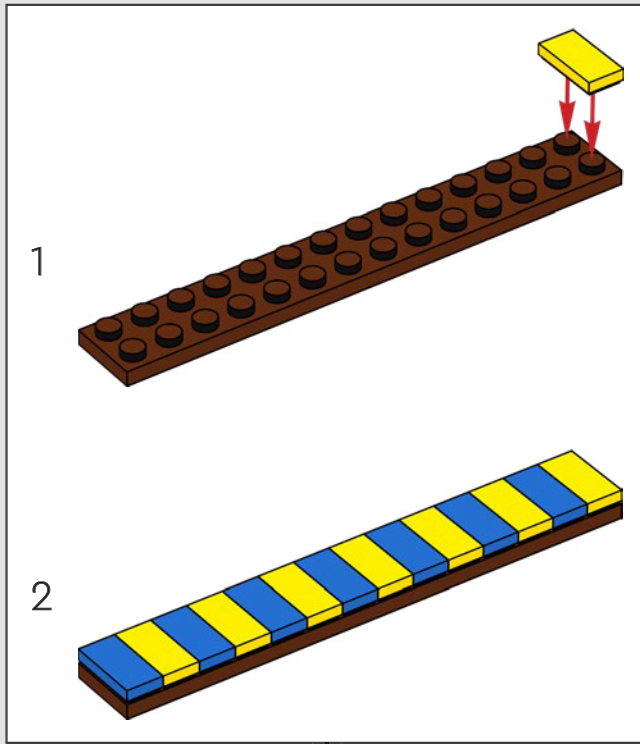

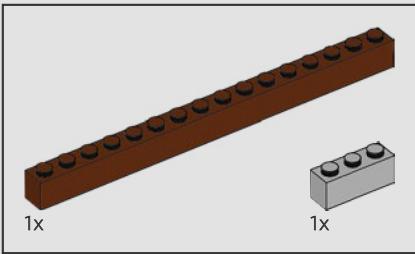

104



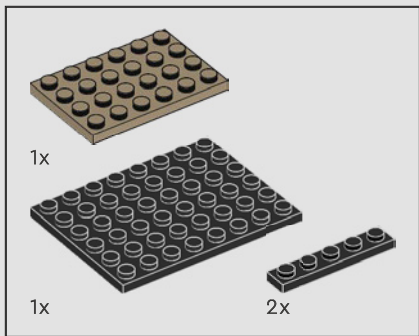

105

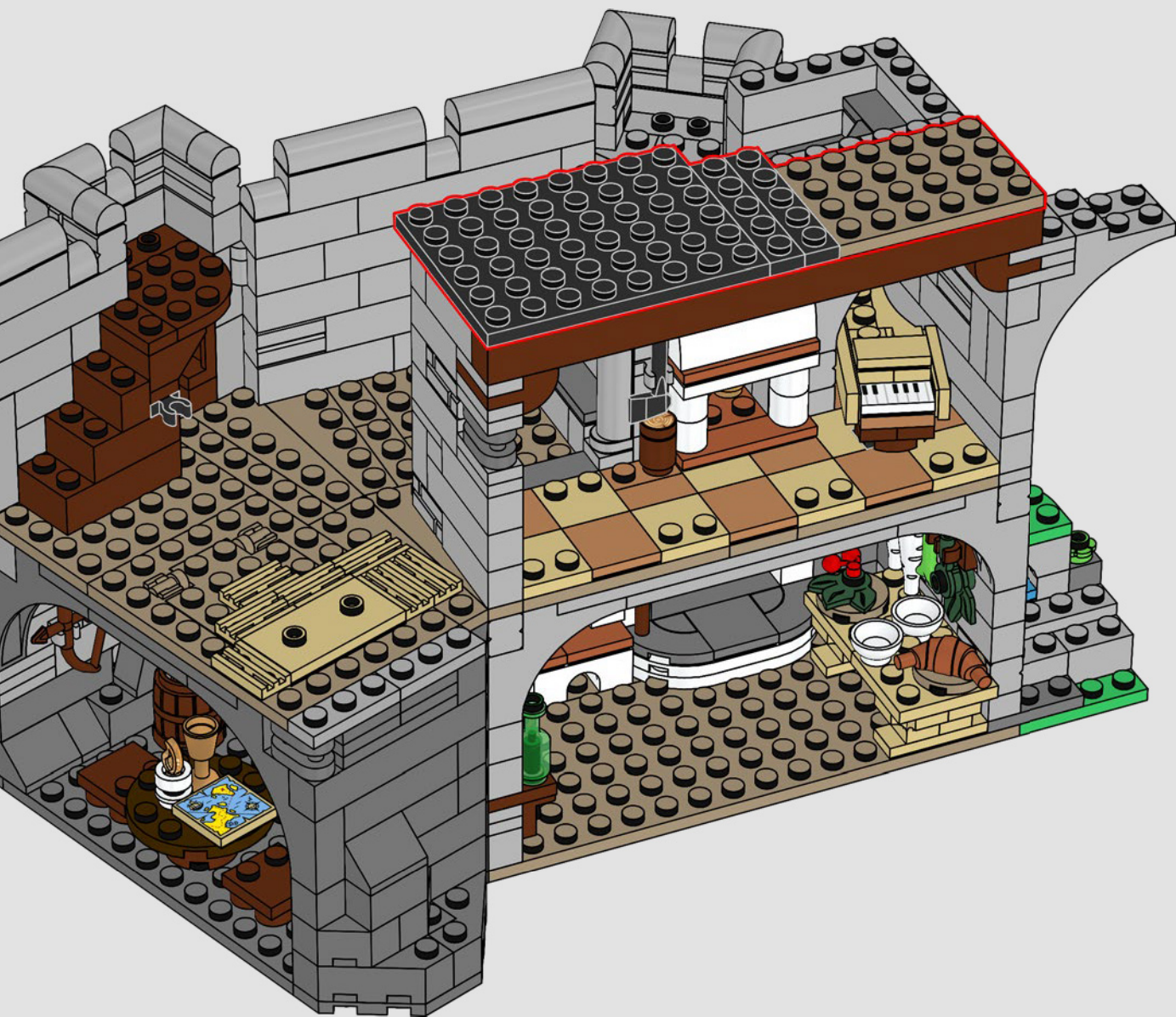

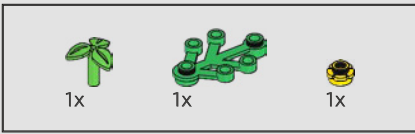

106

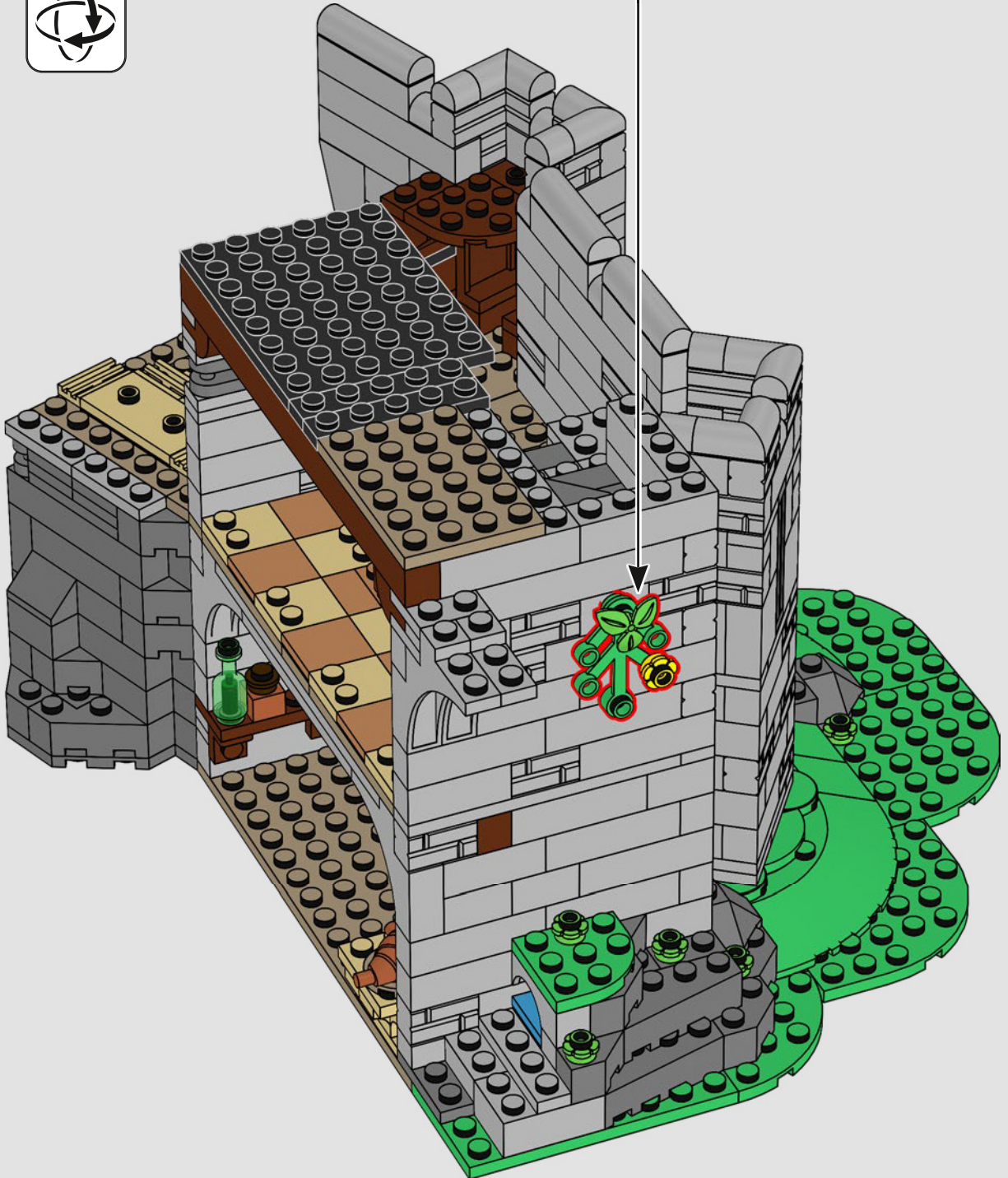
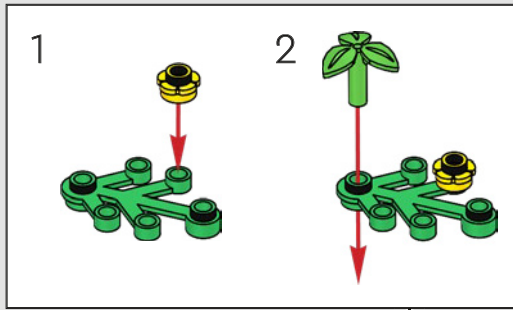

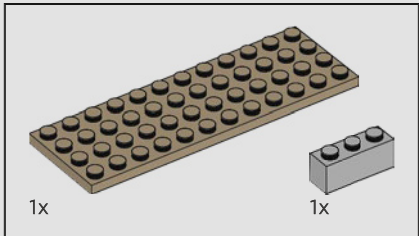
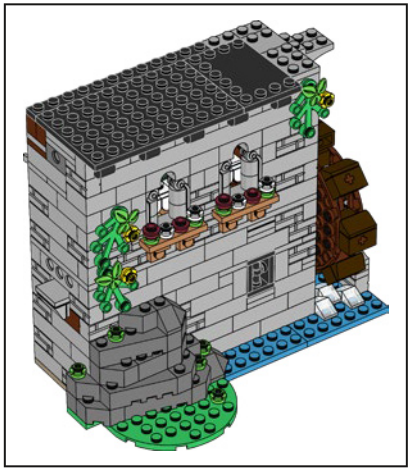

107

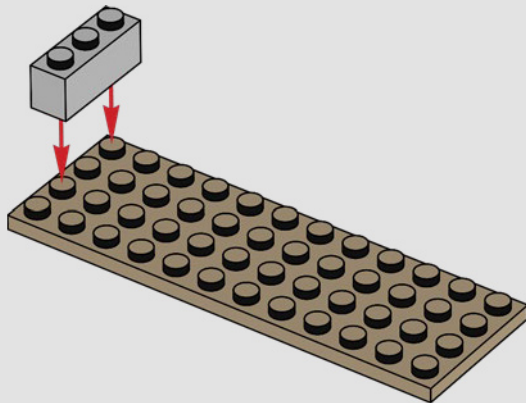

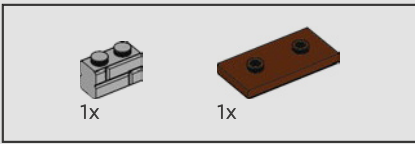

108

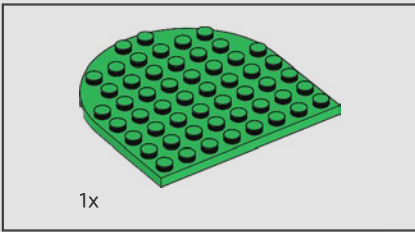
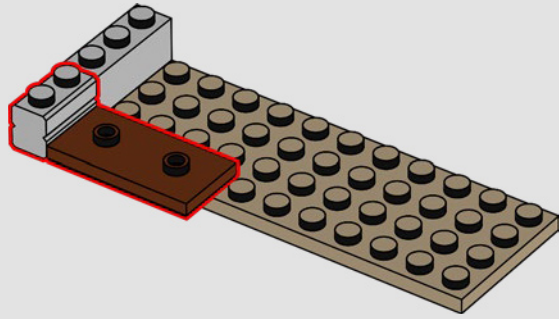

109

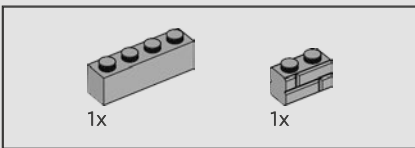
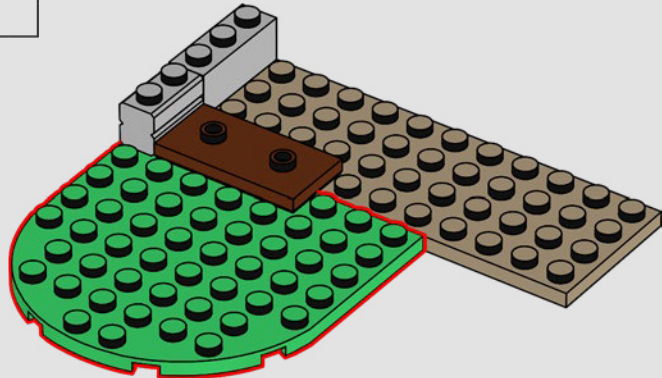

110

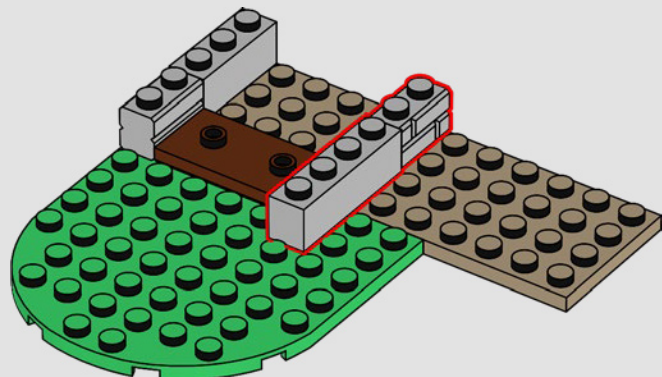

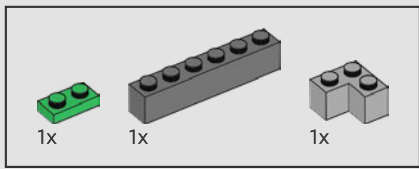

111

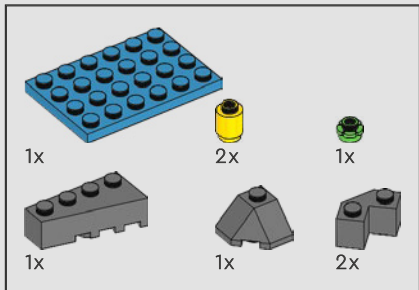
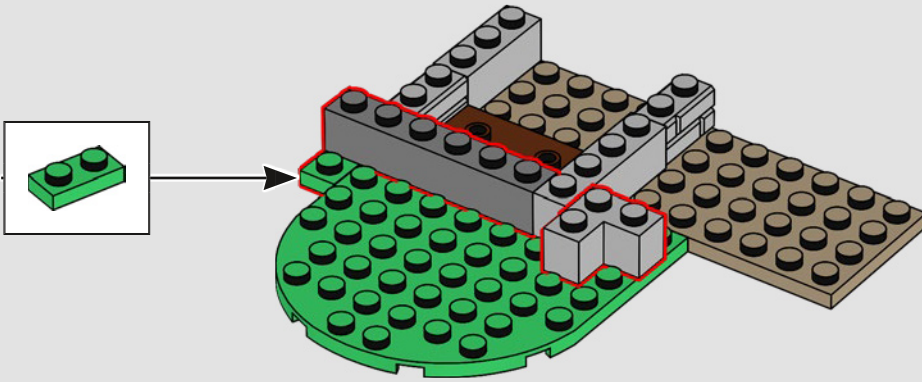

112

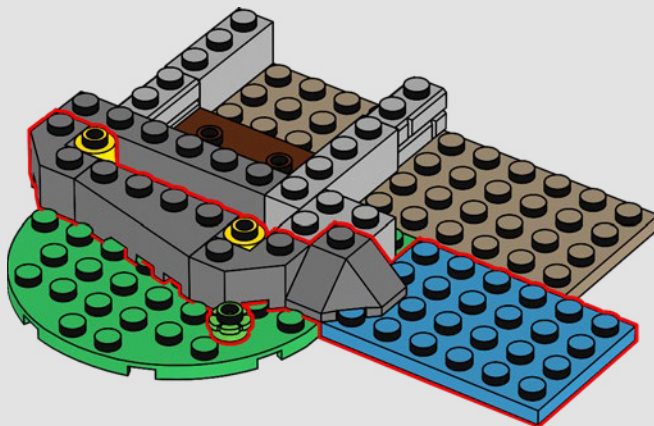

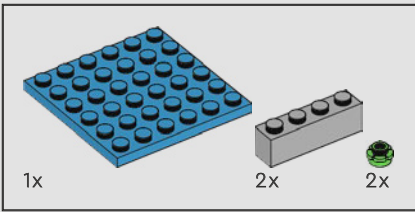

113

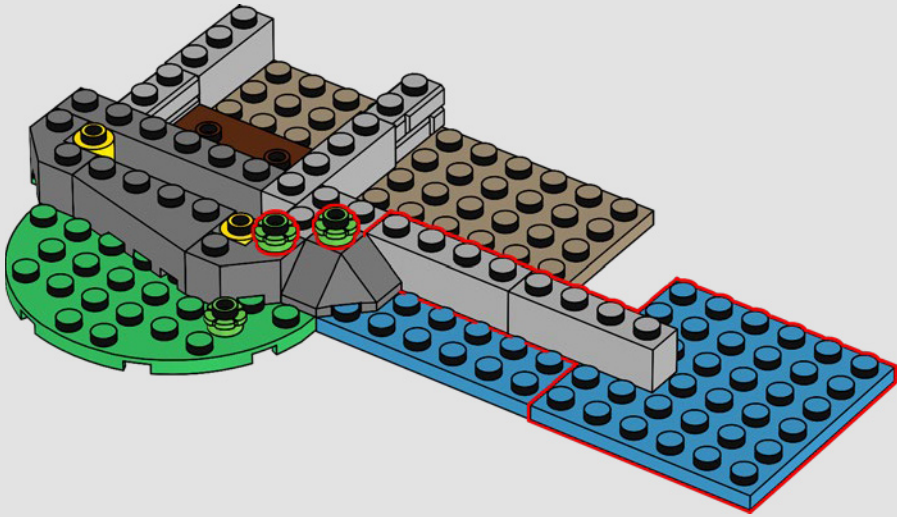

114

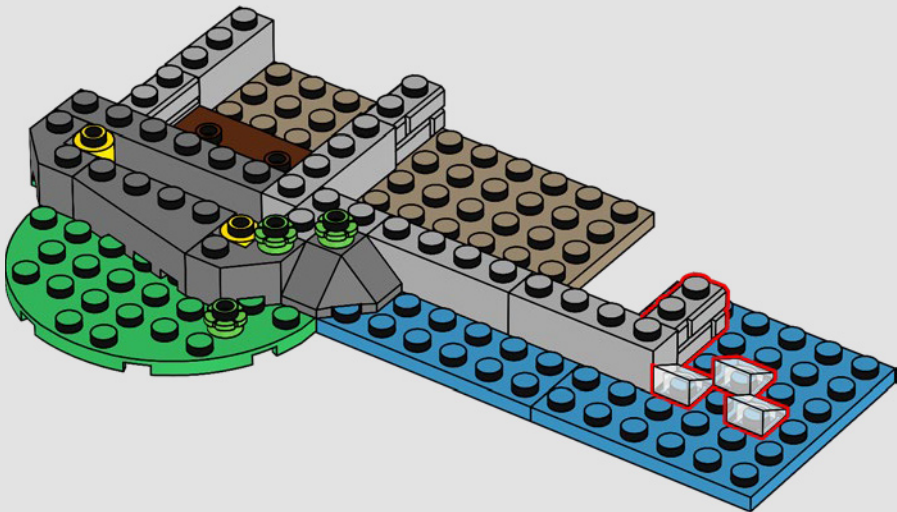

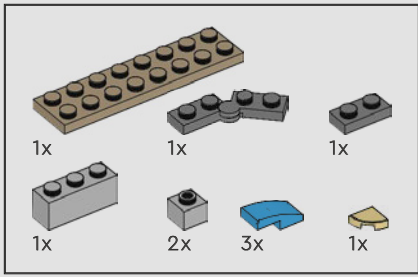

115

1

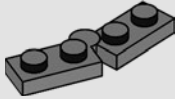

2

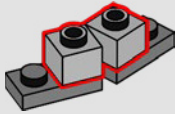

3

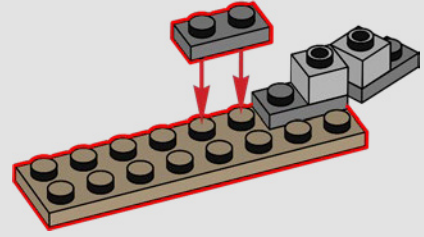

4

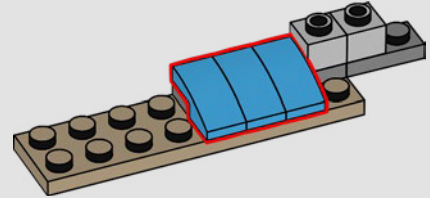

5

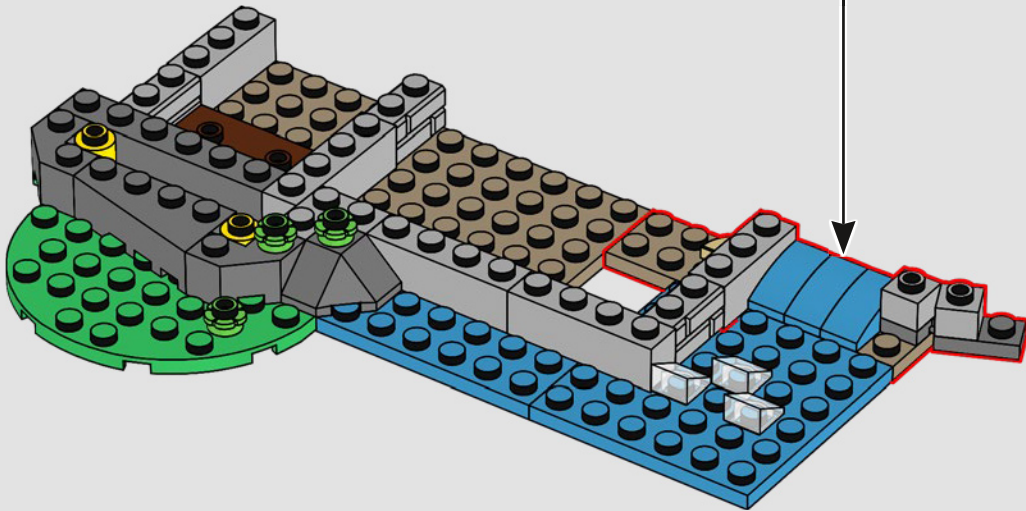
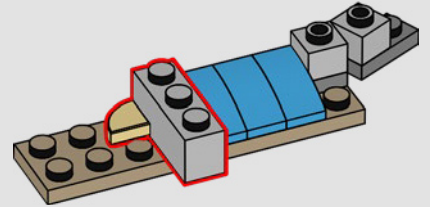

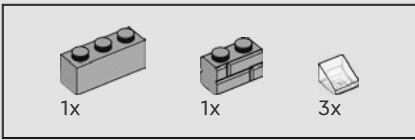

116

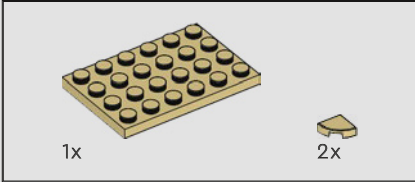
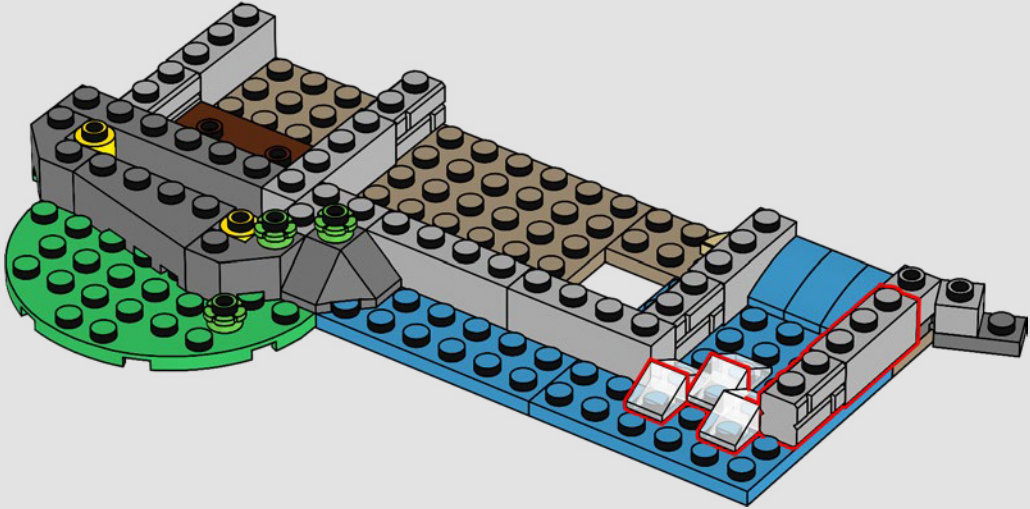

117

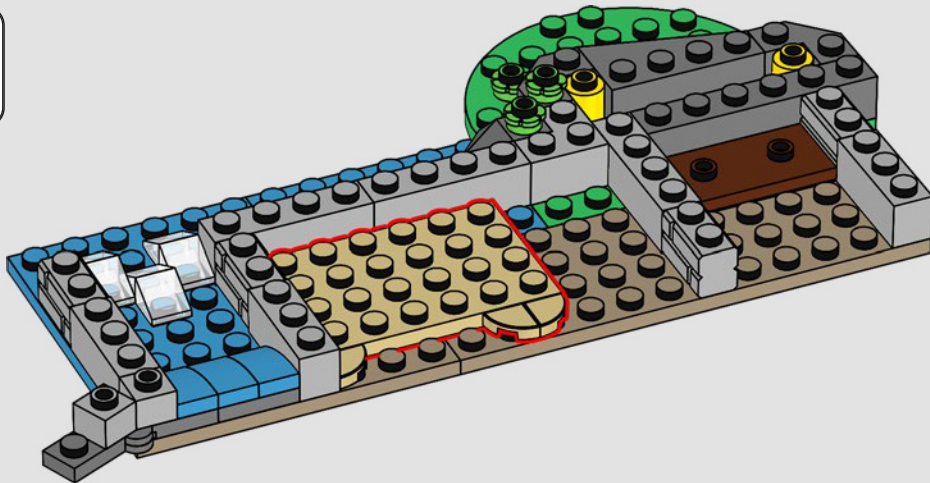



*Cet endroit semble idéal pour placer
une meule, qui pourrait même être
alimentée par le ruisseau...*

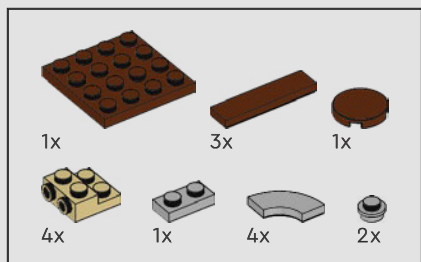

118

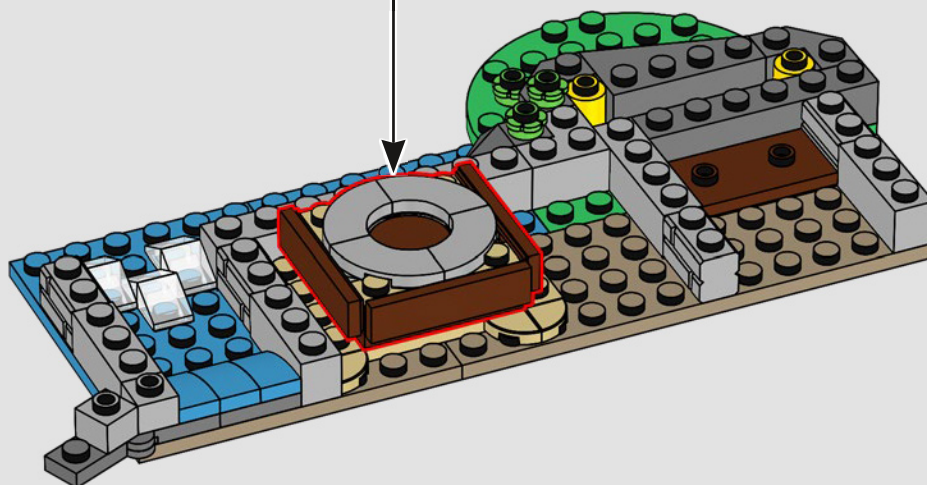
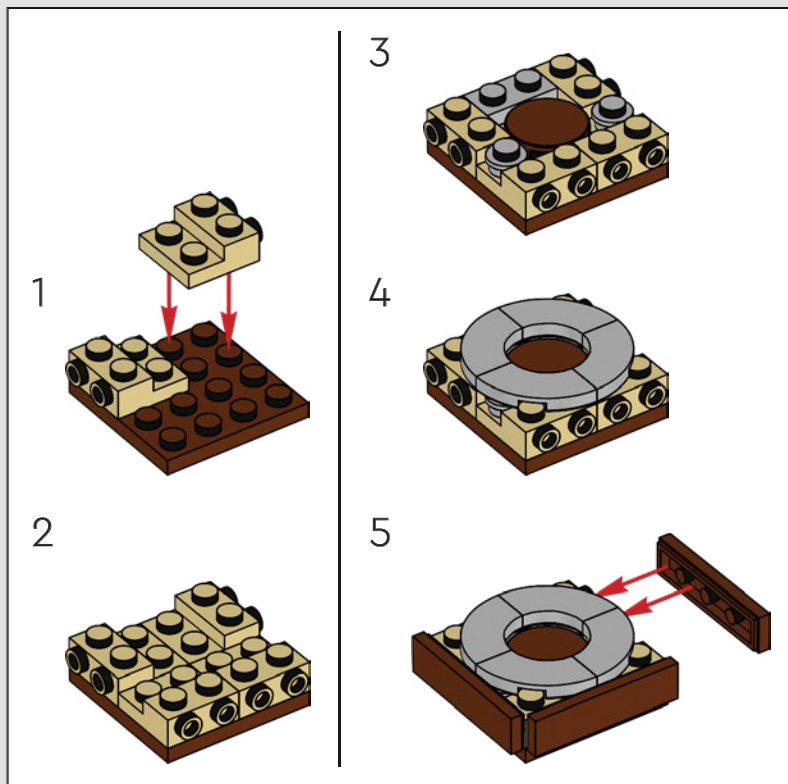

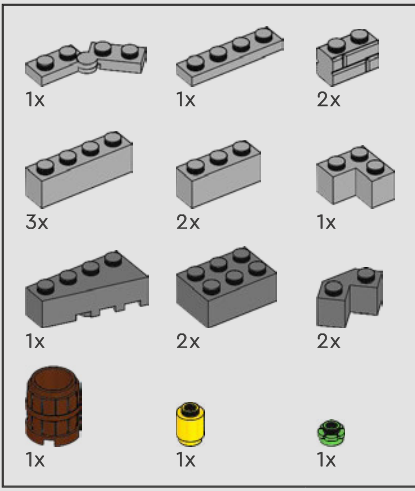

119

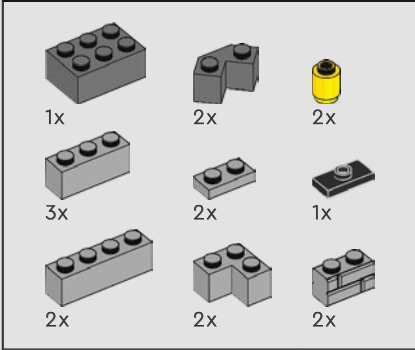
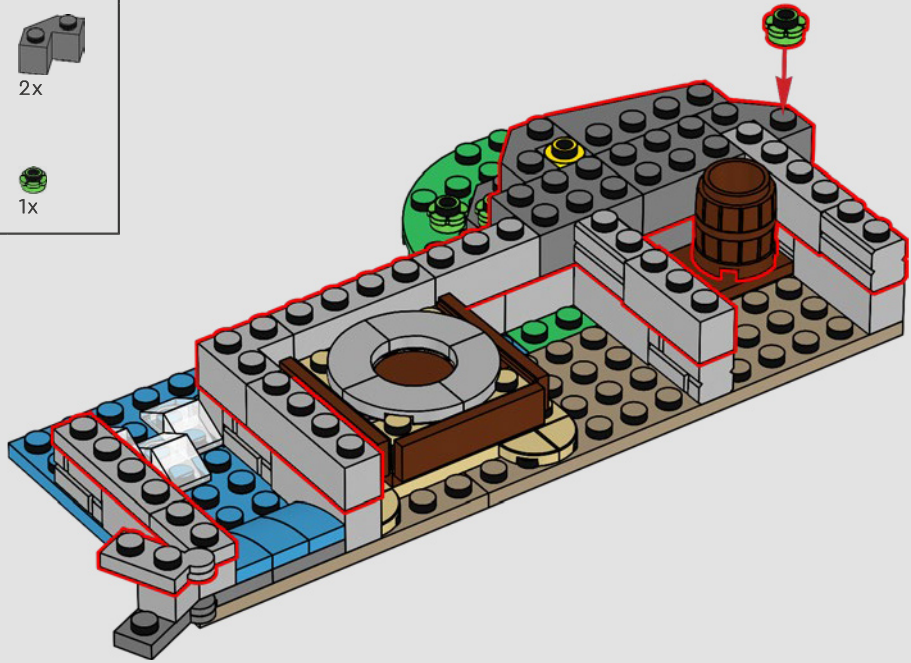

120

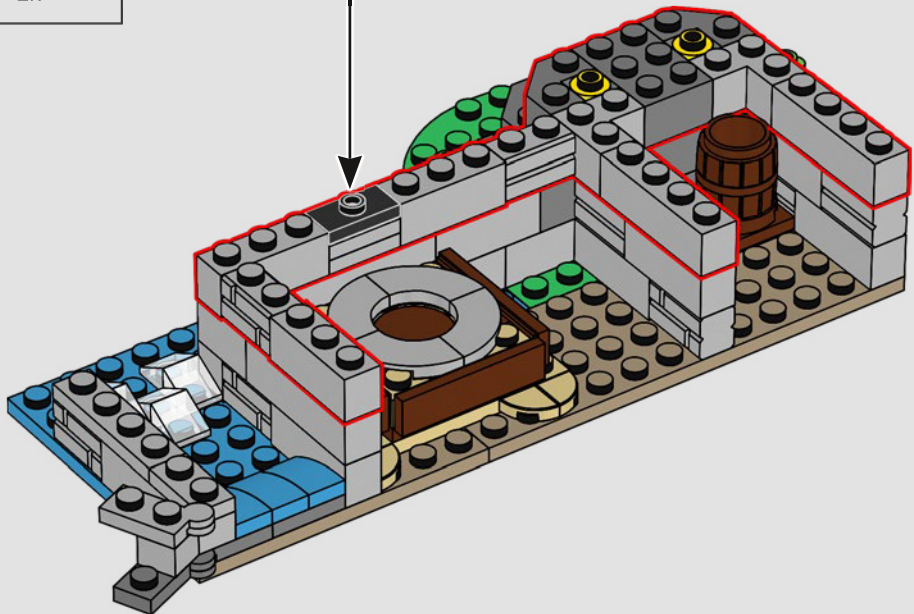
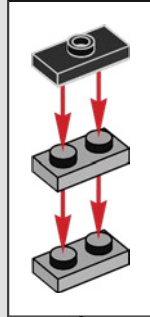

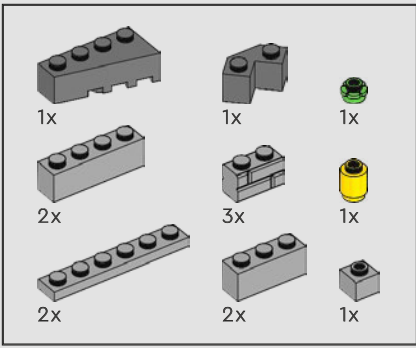

121

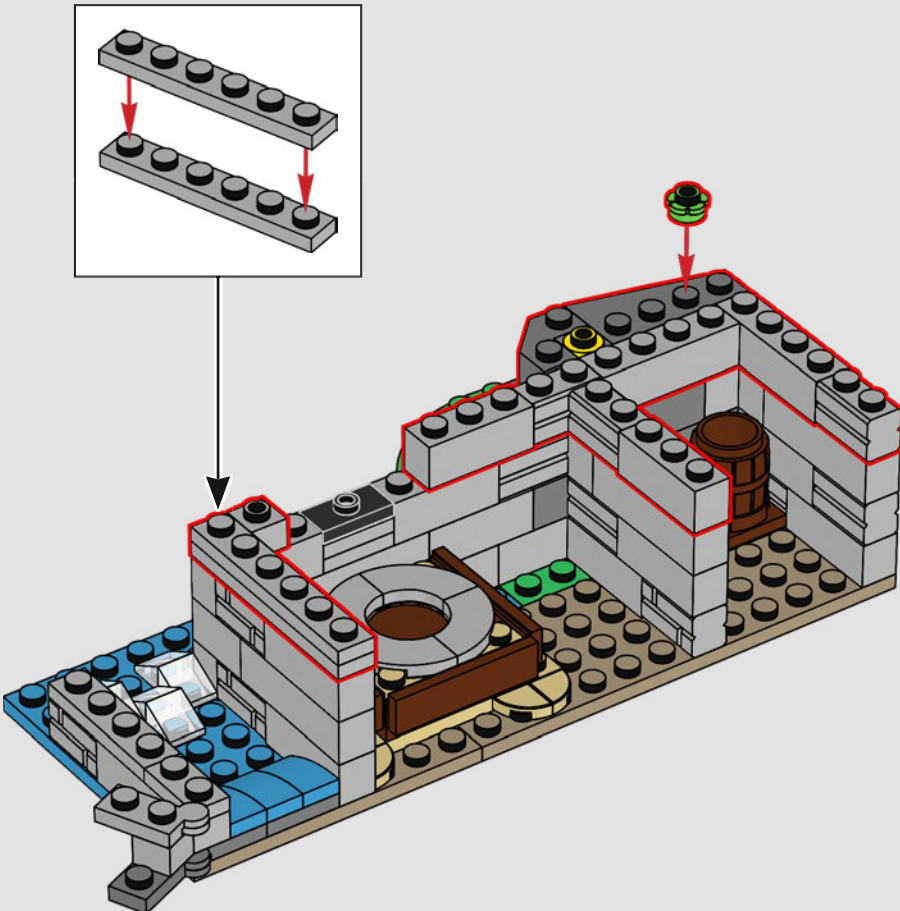

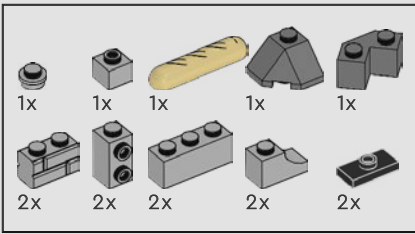

122

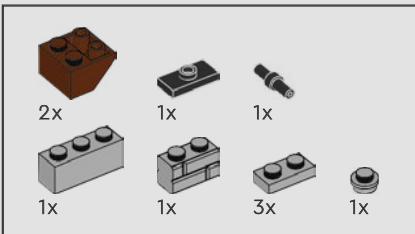
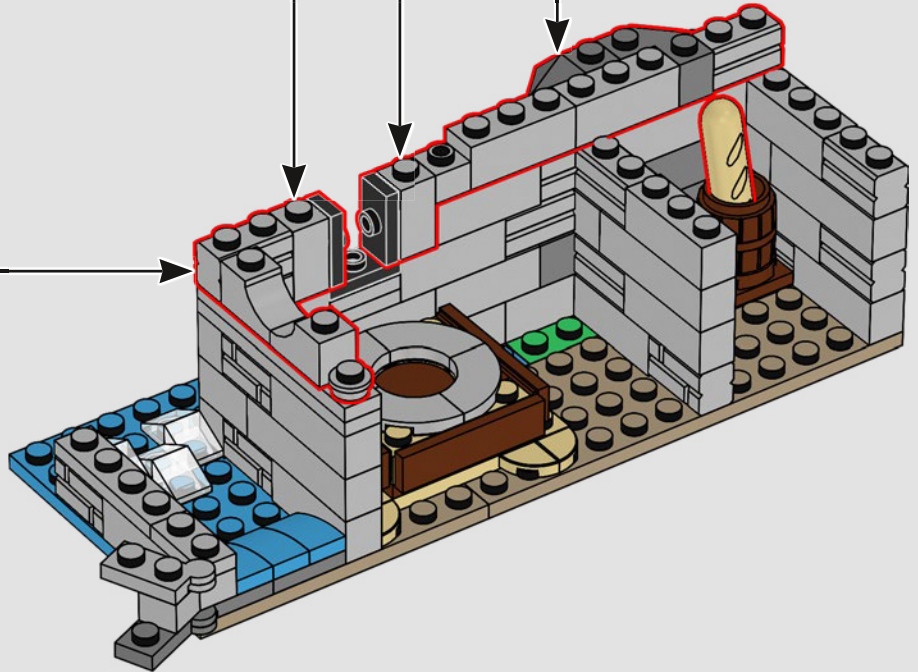
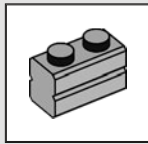
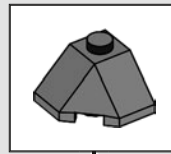
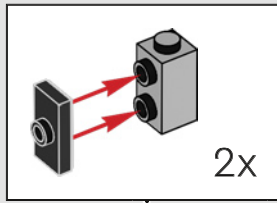

123

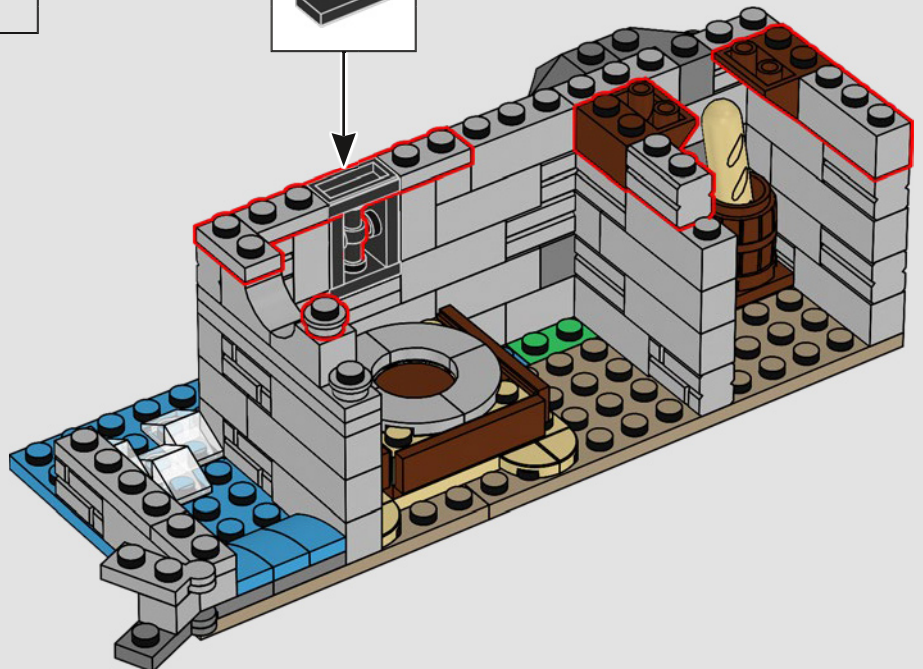
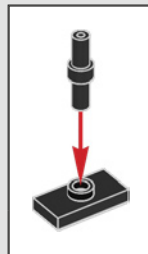

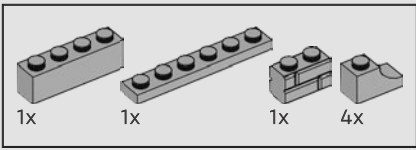

124

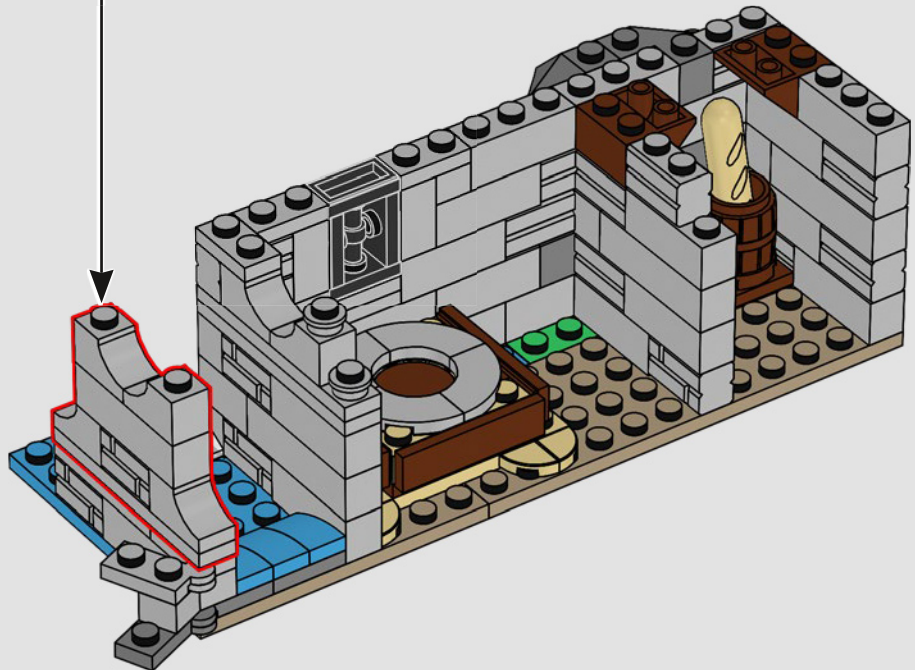
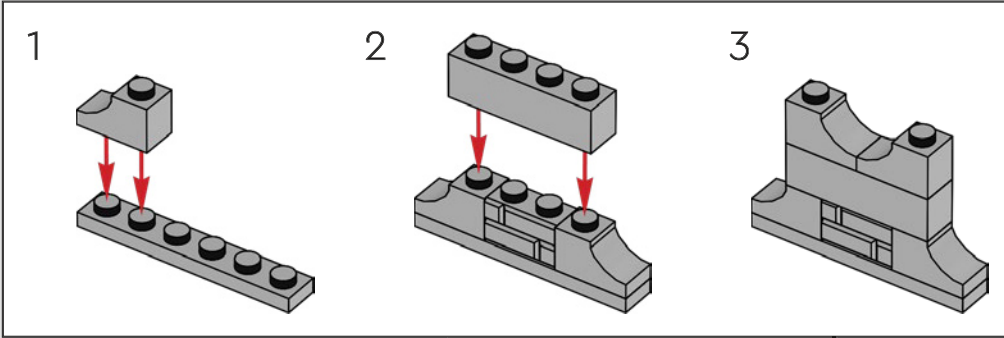

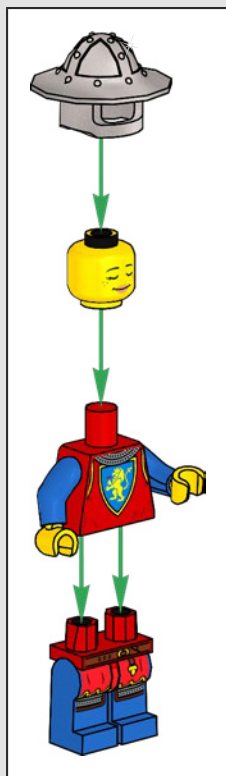

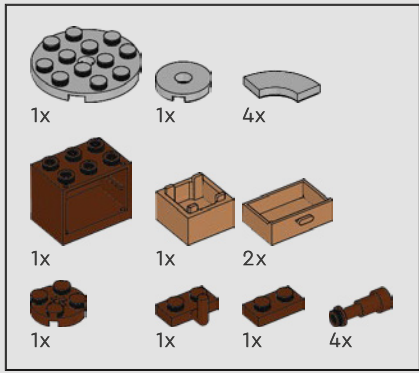

125

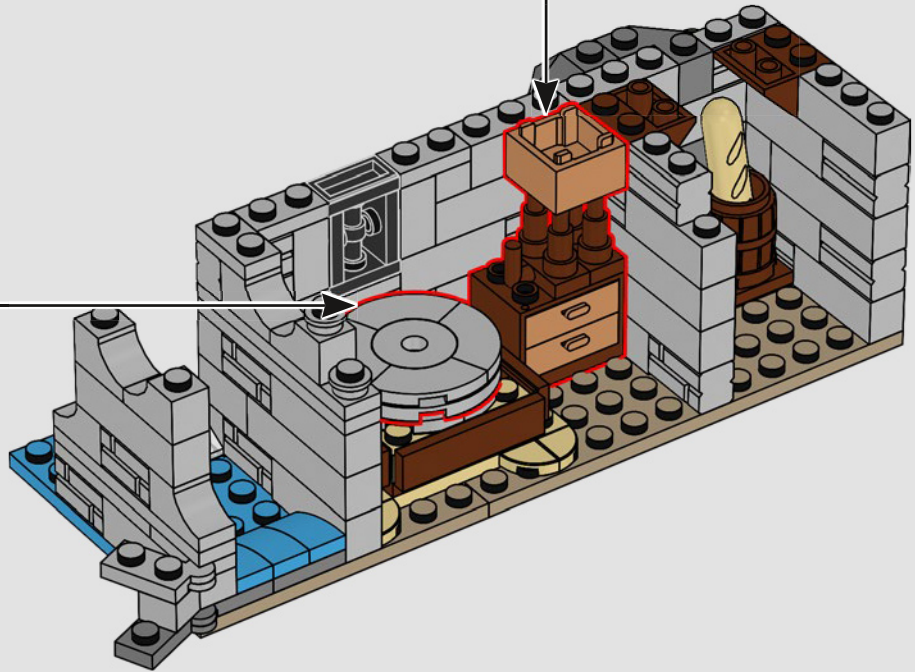
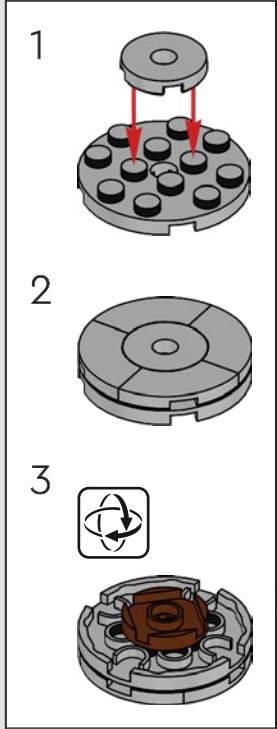
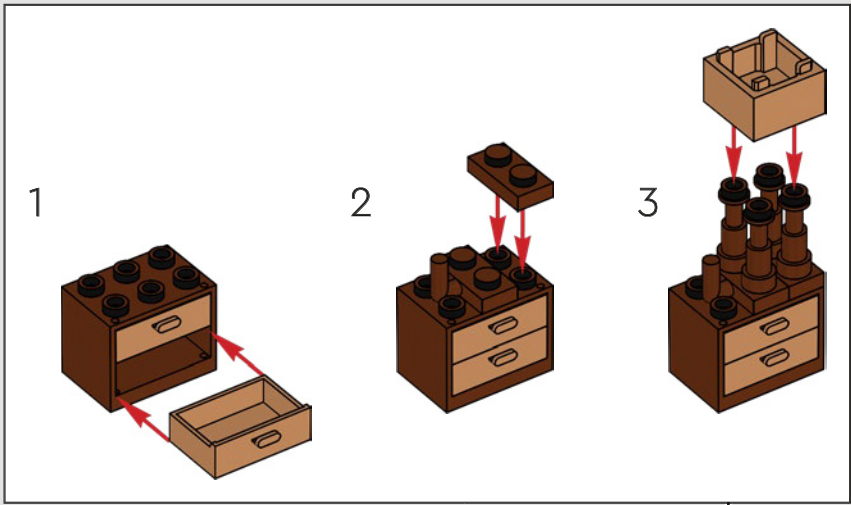

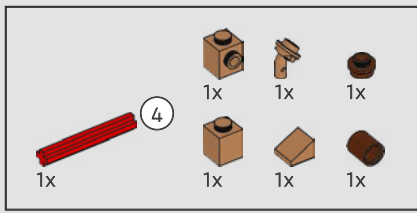

126

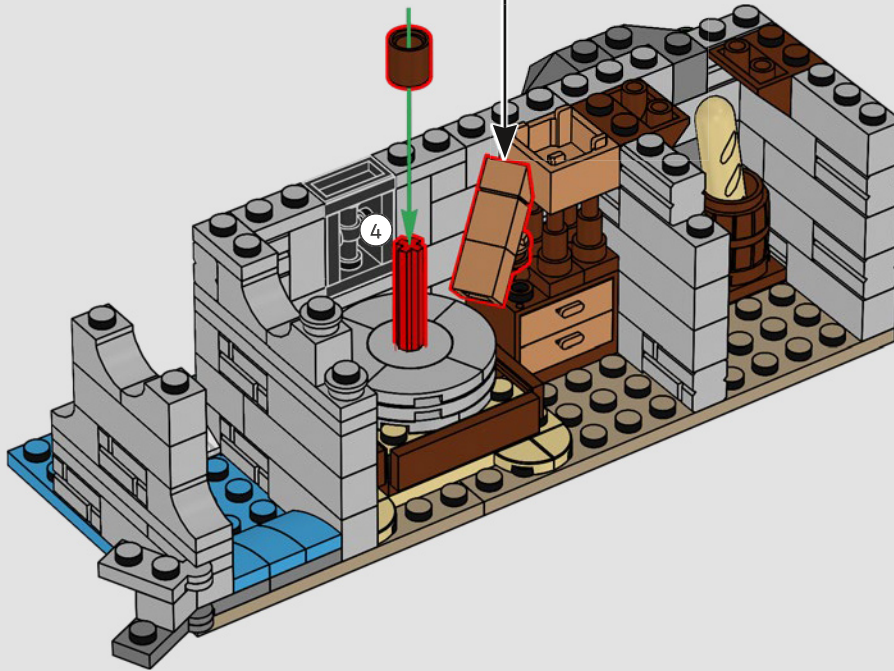
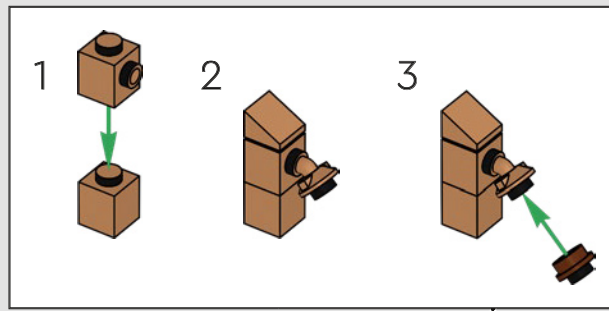

127

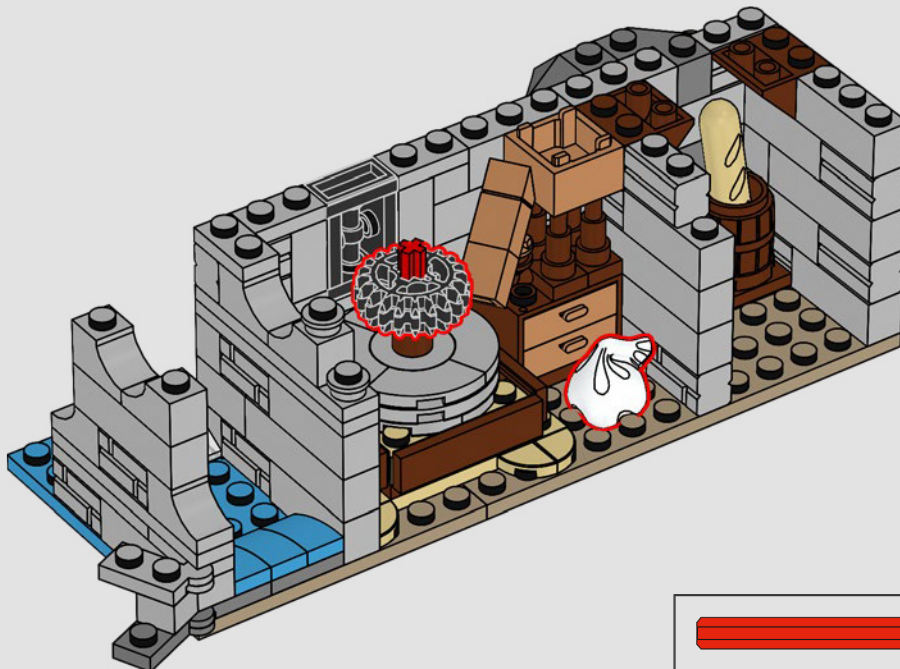

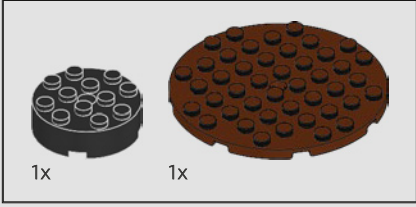
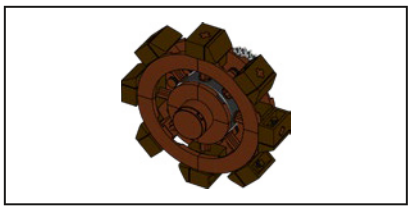

128

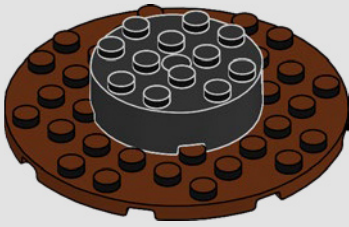

129

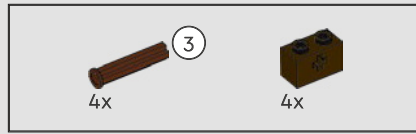
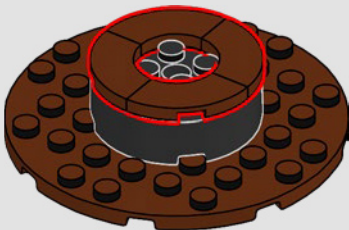

130

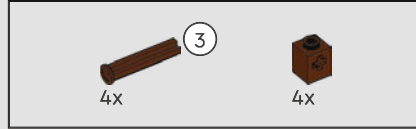
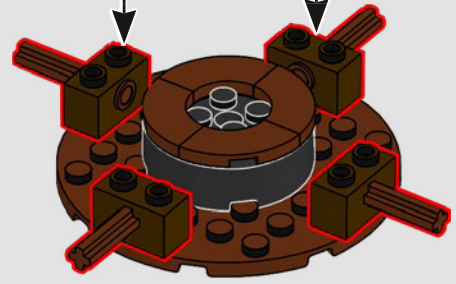
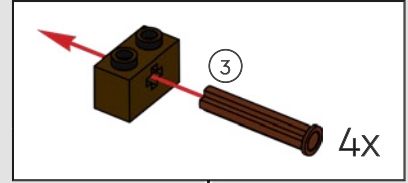

131

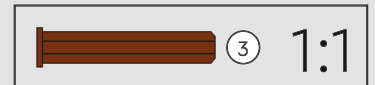
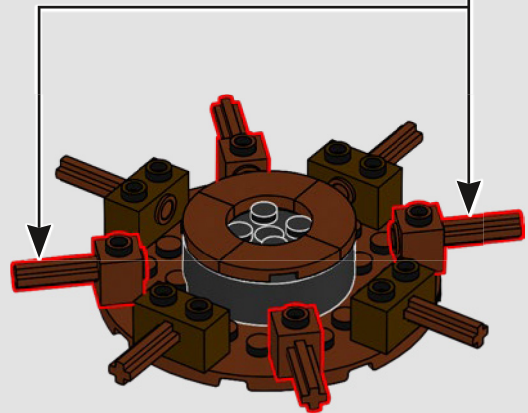
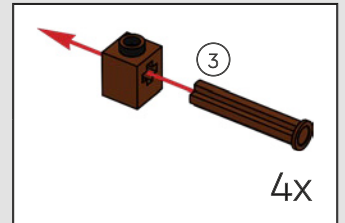

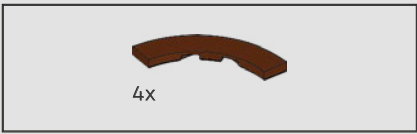

132

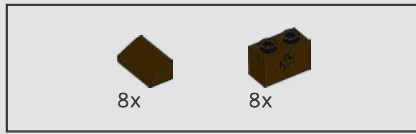
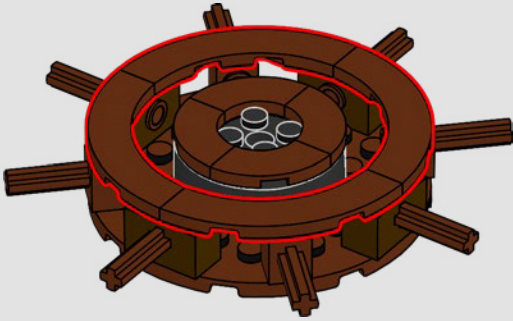

134

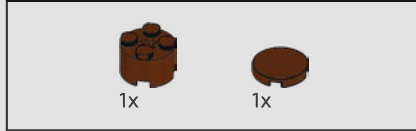
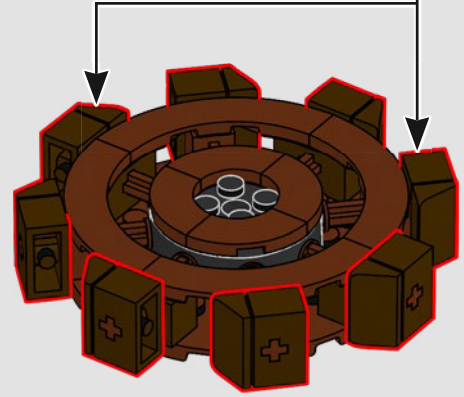
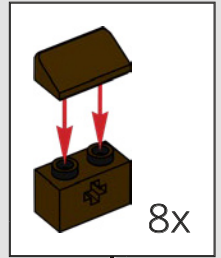

135

133

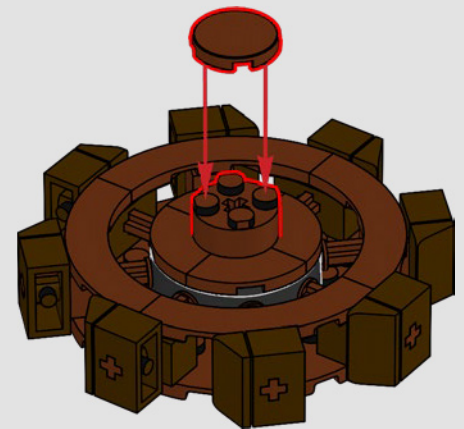
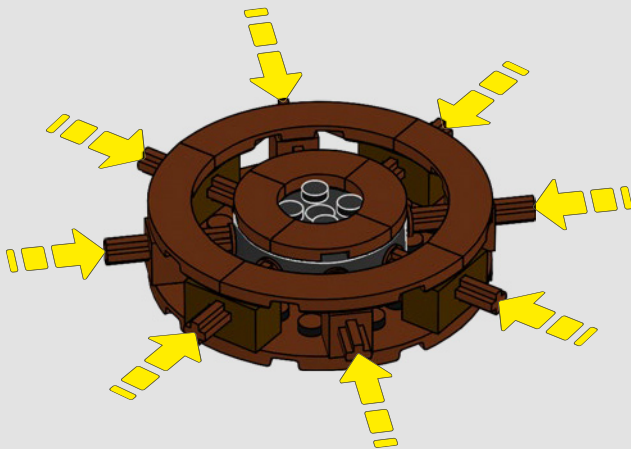

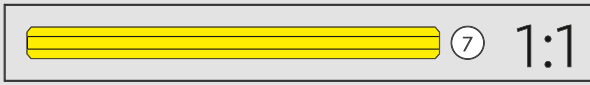
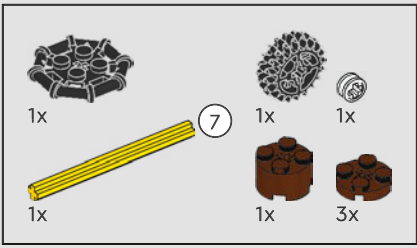

136

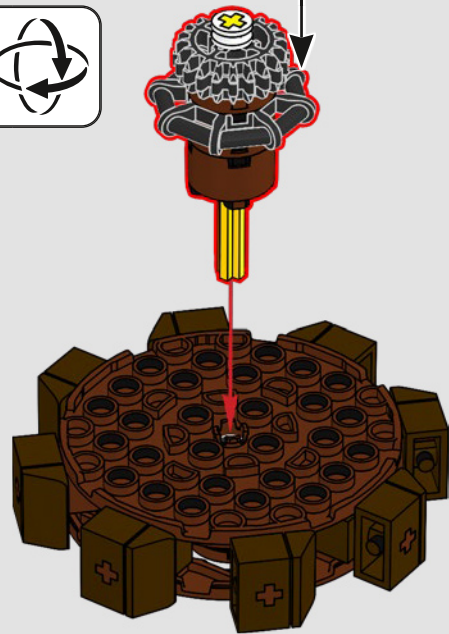
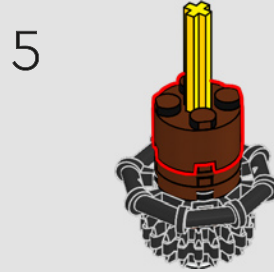
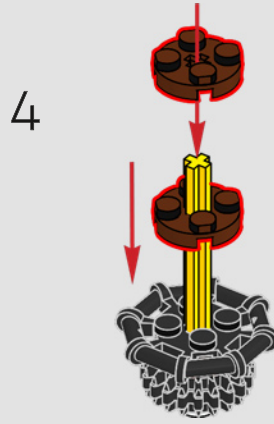
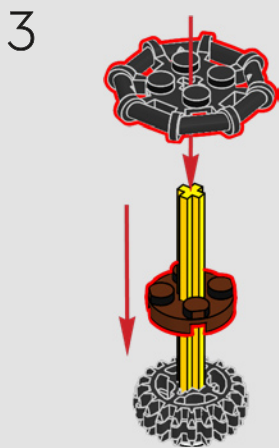
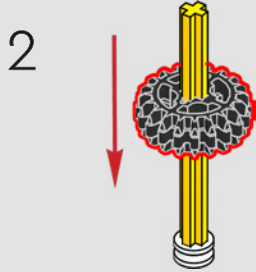
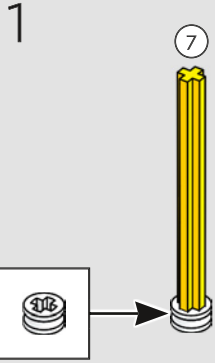



*Cette roue à aubes est vraiment puissante !
Elle sera parfaite pour faire tourner la meule !*

137

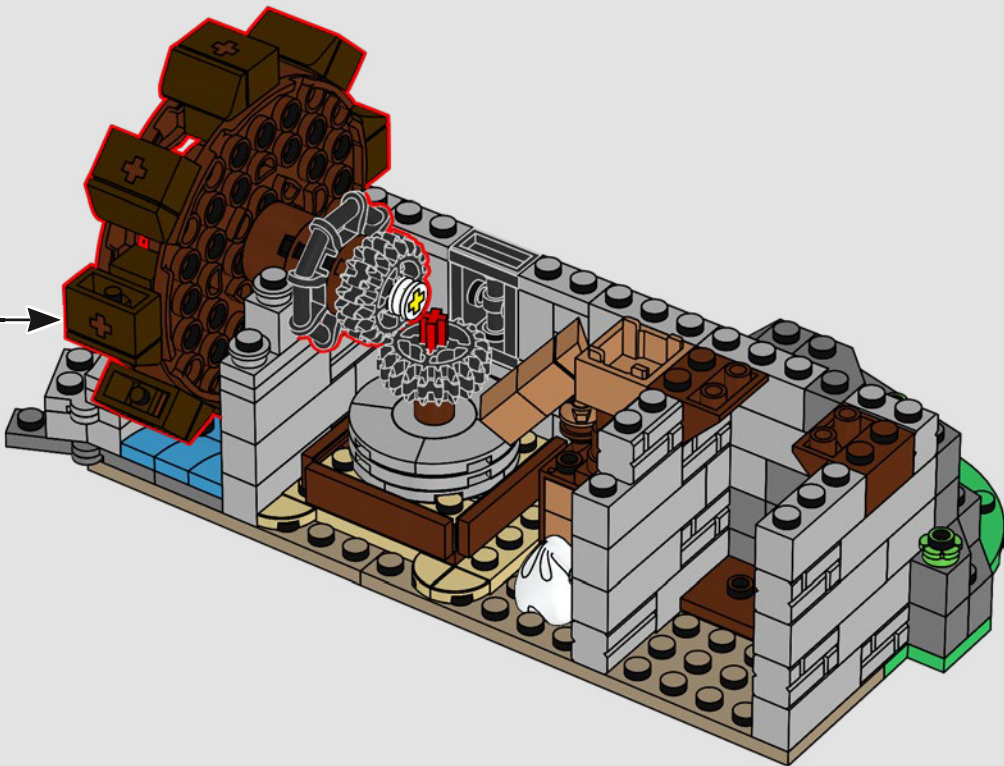

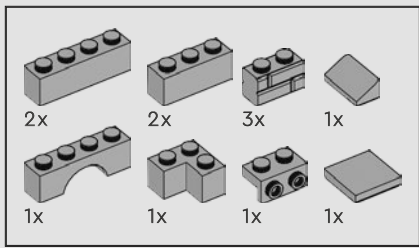

138

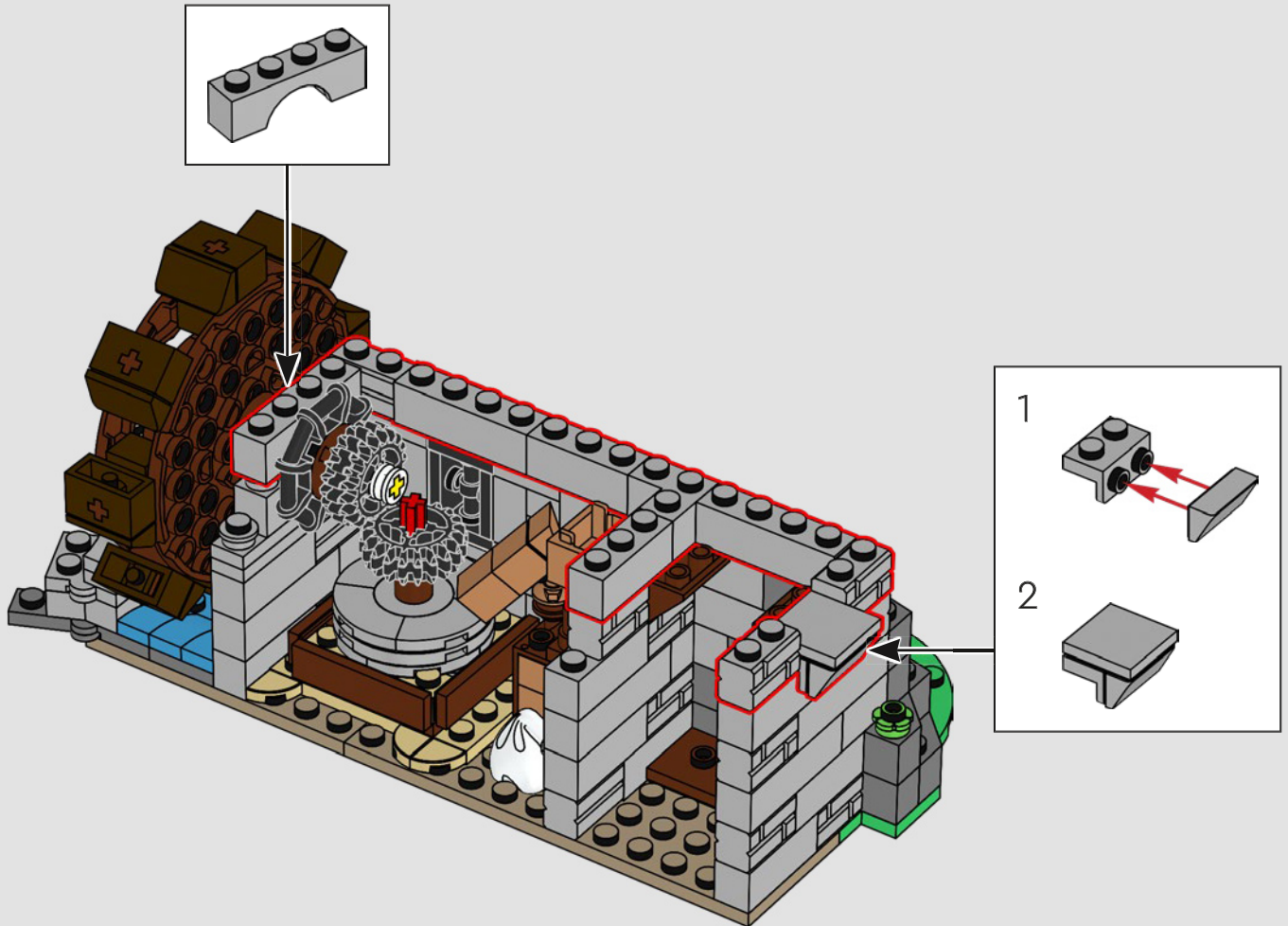



Un nid d'oiseau !

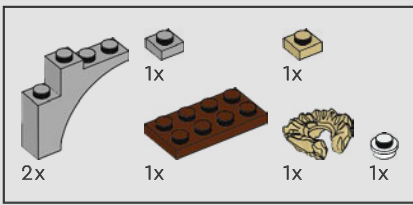

139

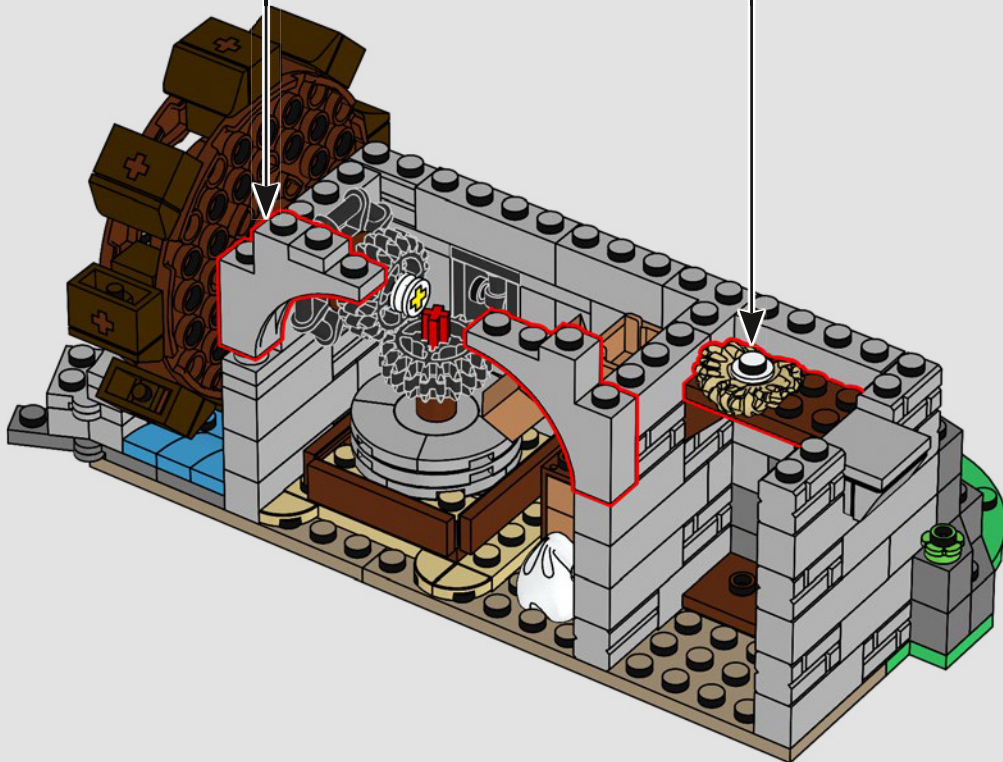
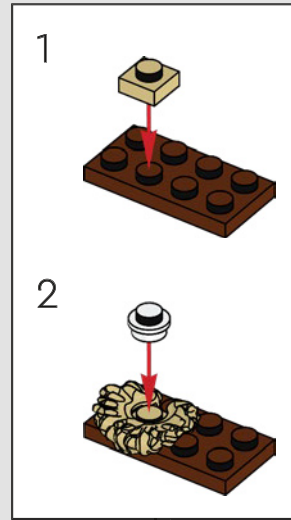
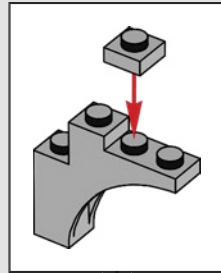

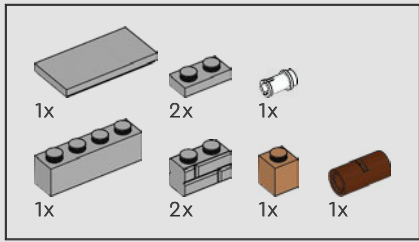

140

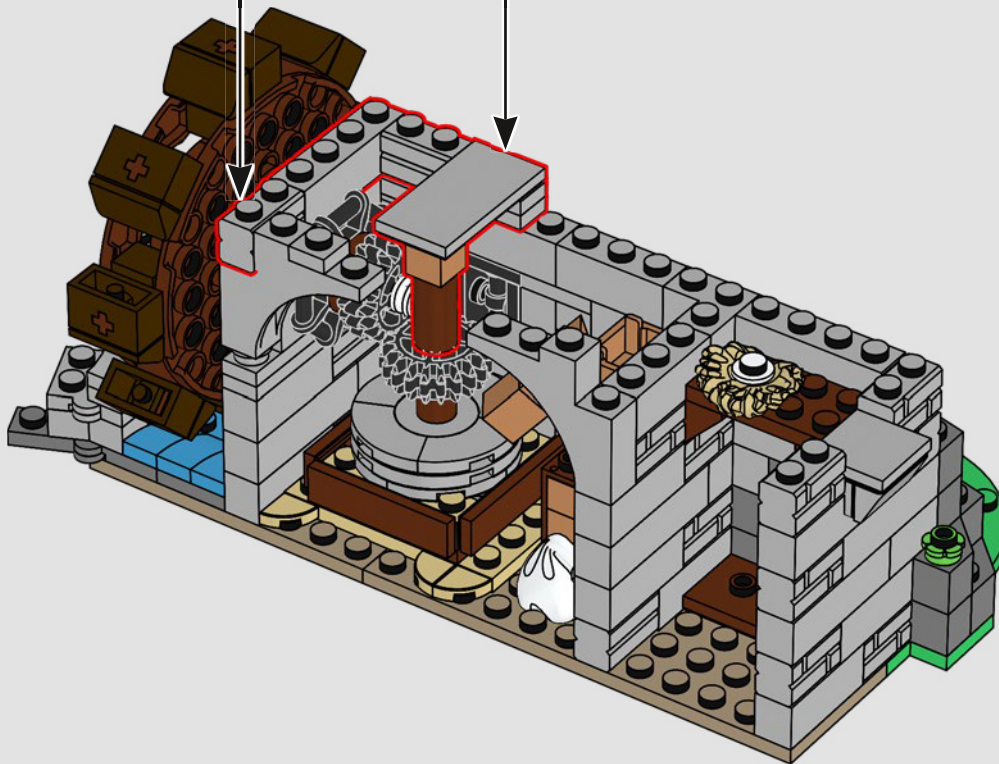
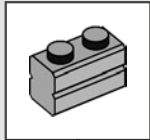
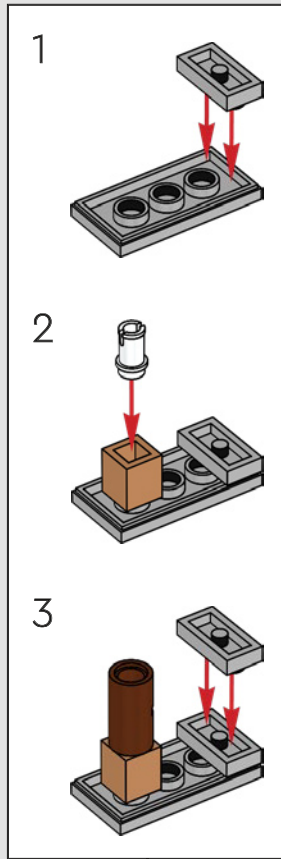

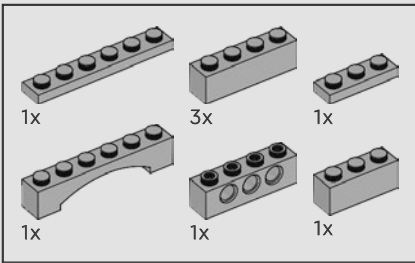

141

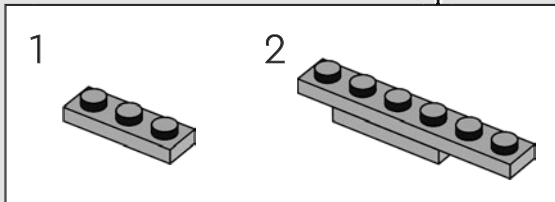
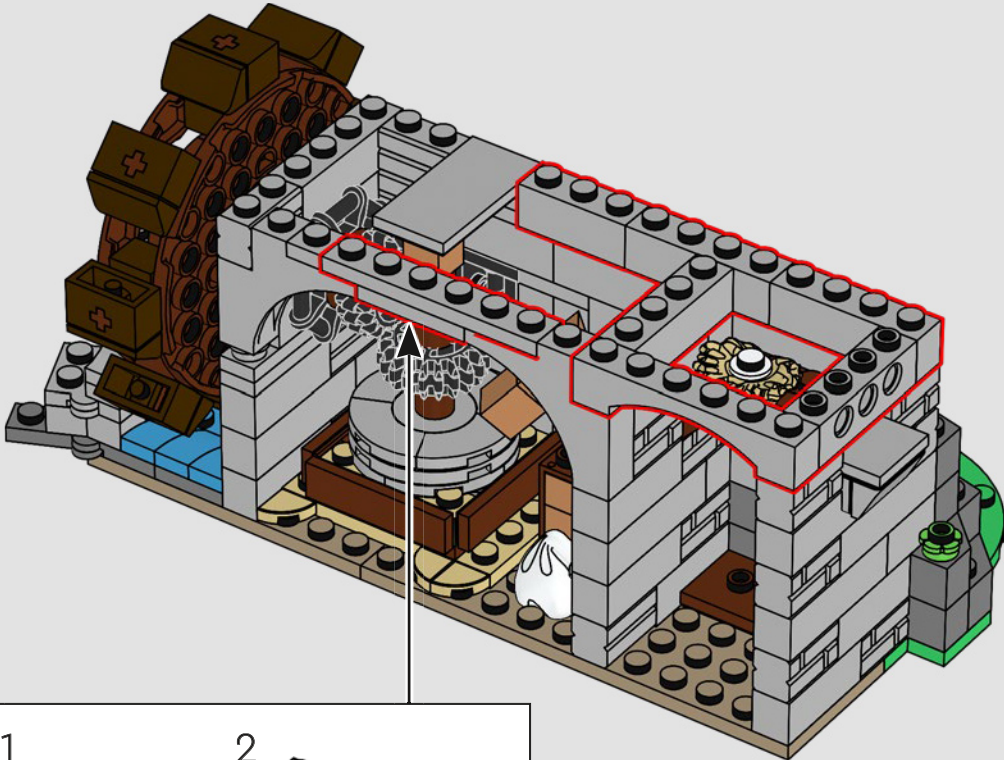

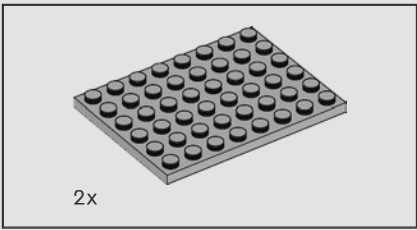

142

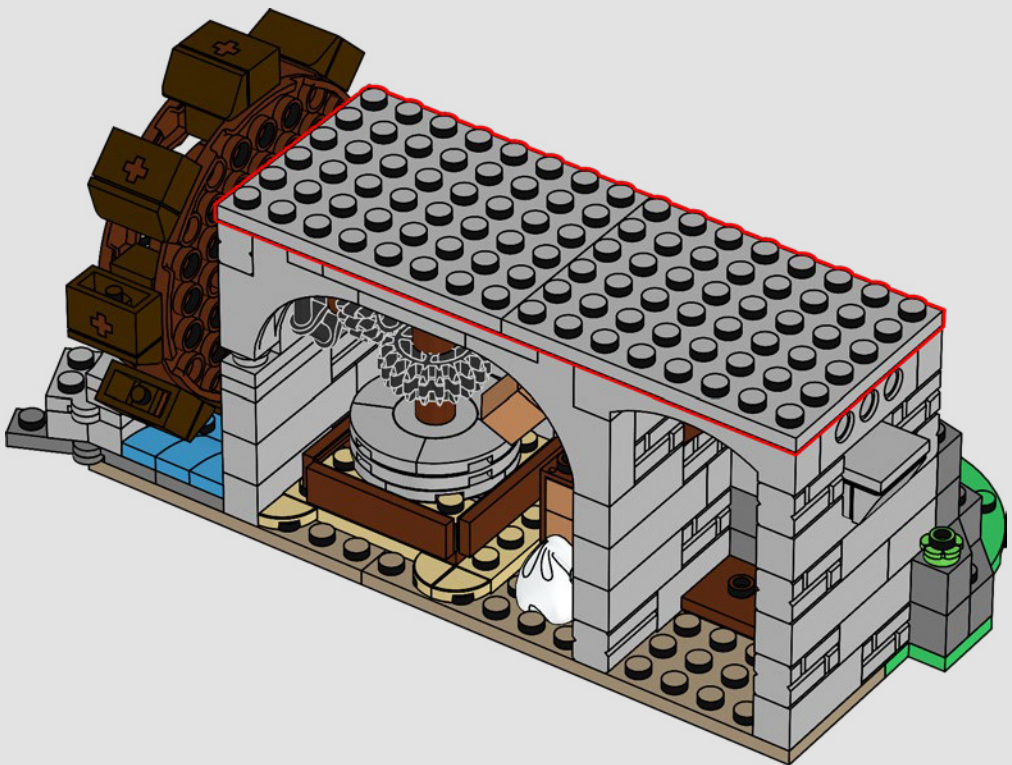

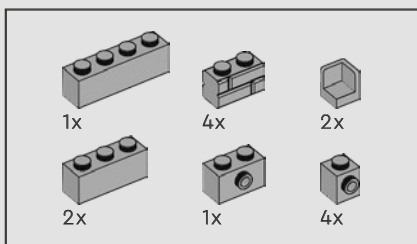

143

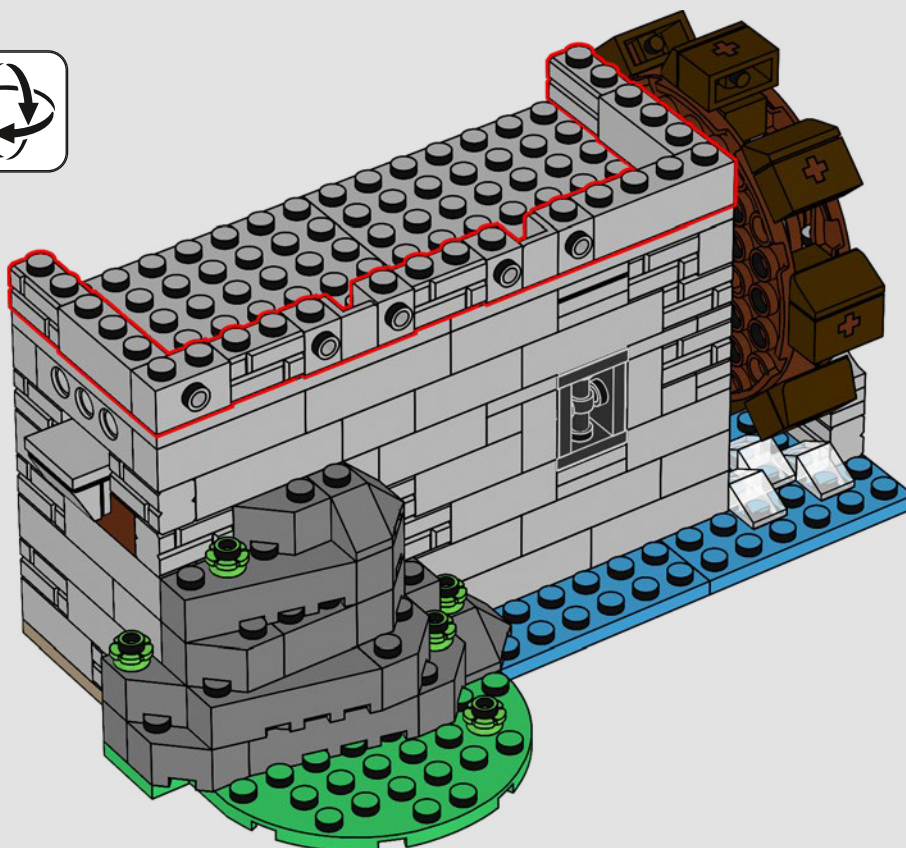

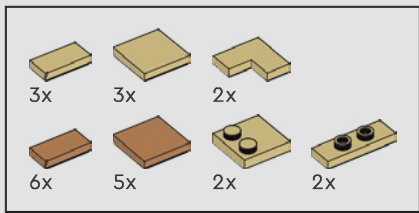

144

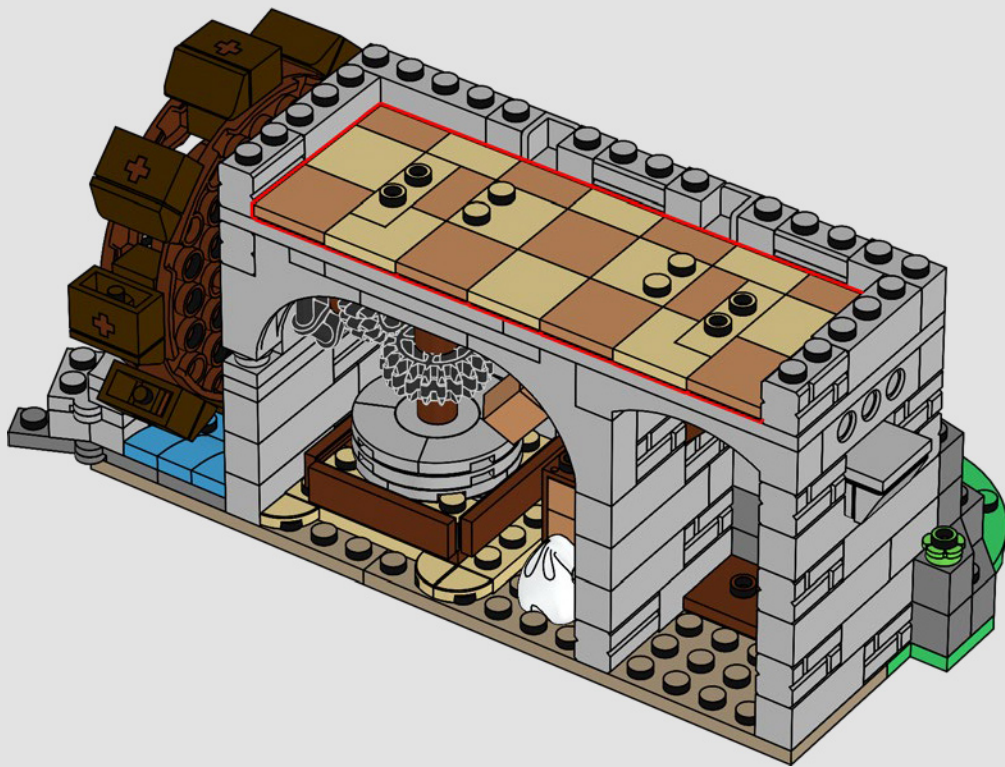

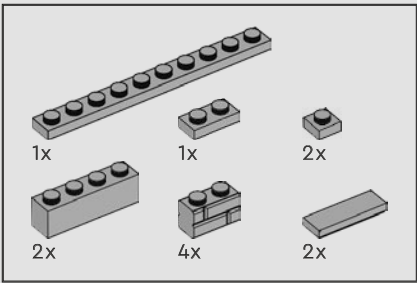

145

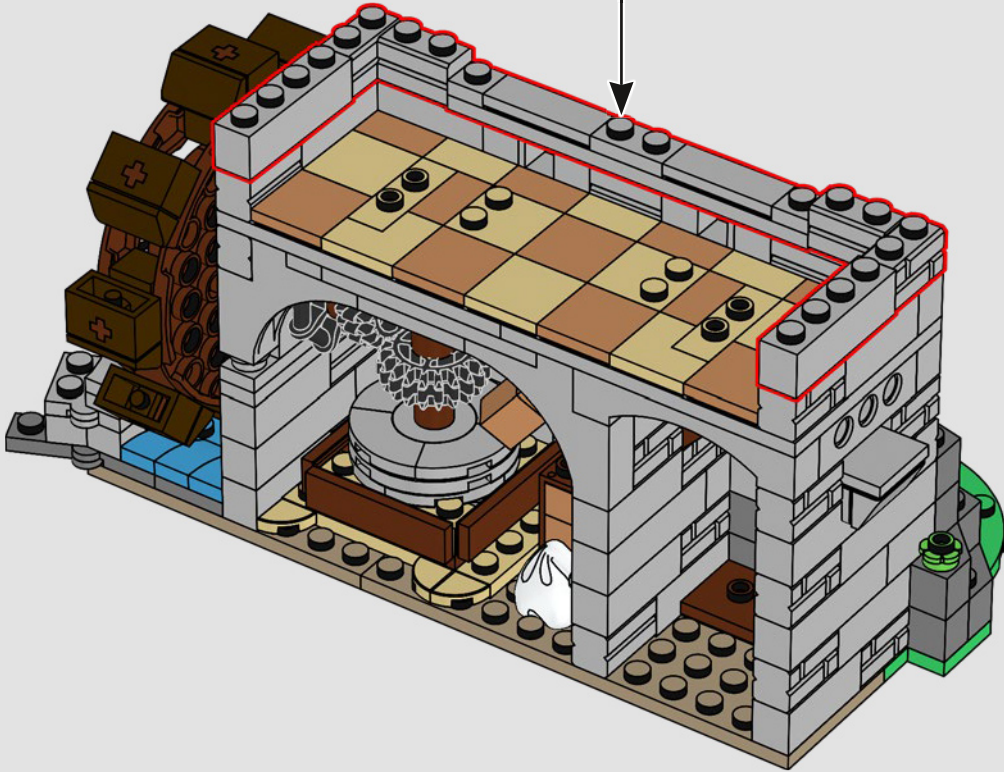
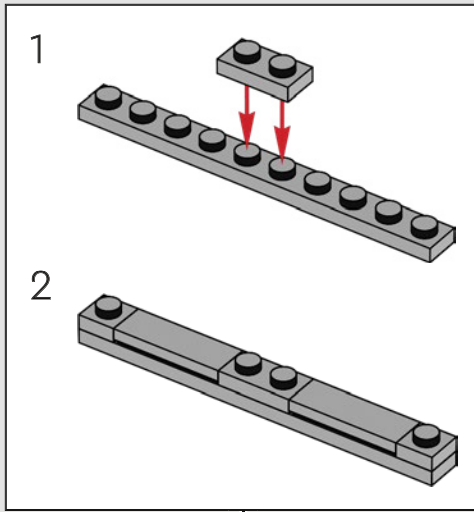

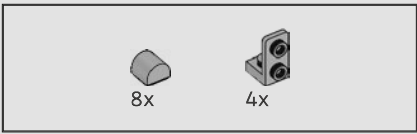

146

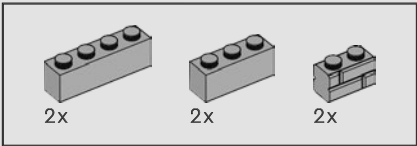
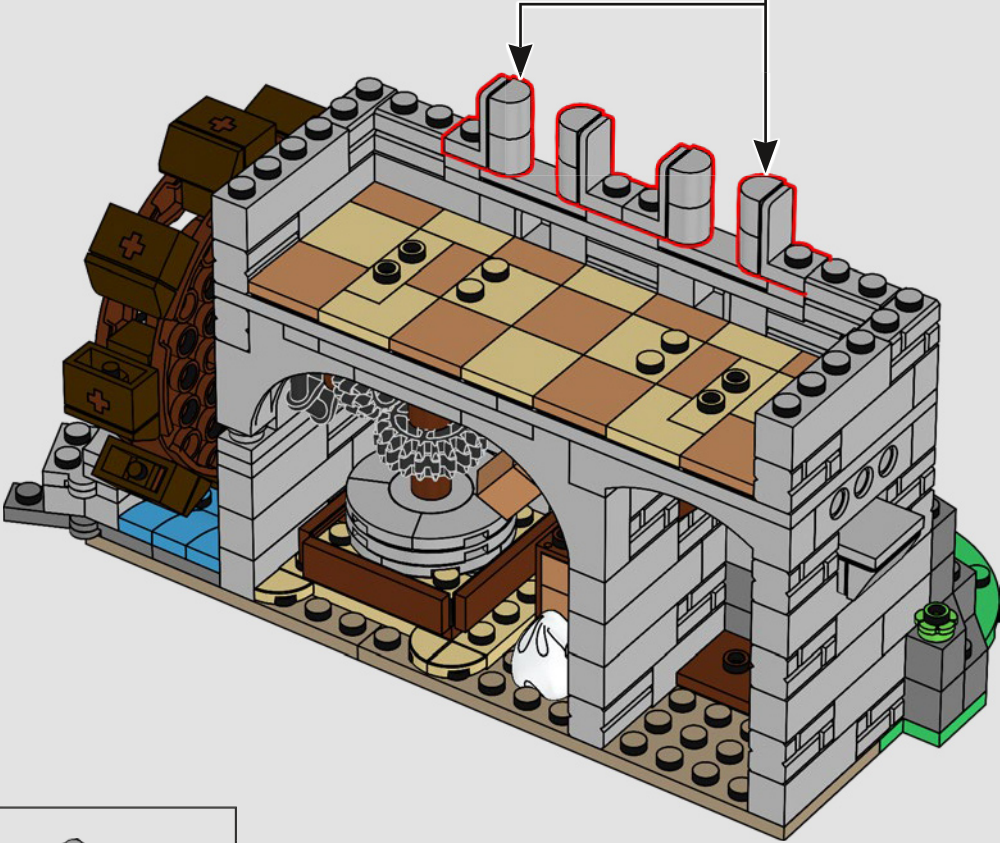
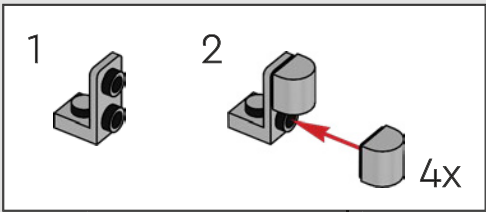

147

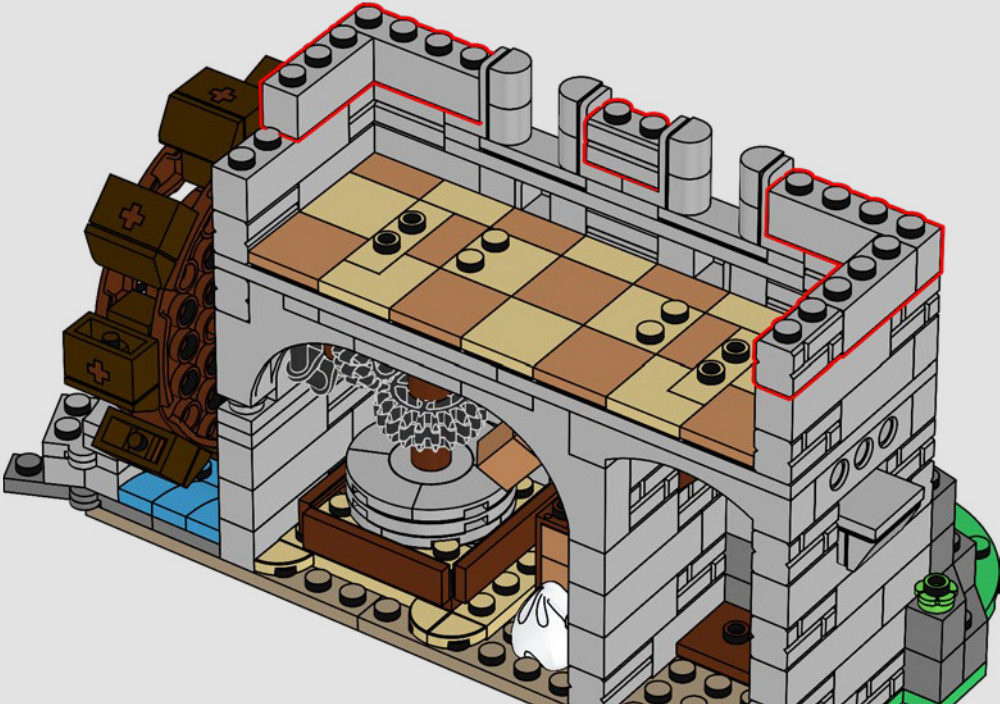

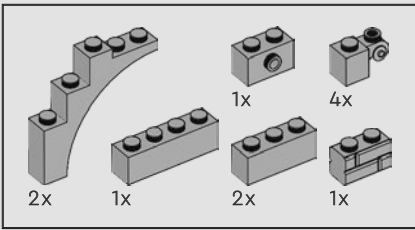

148

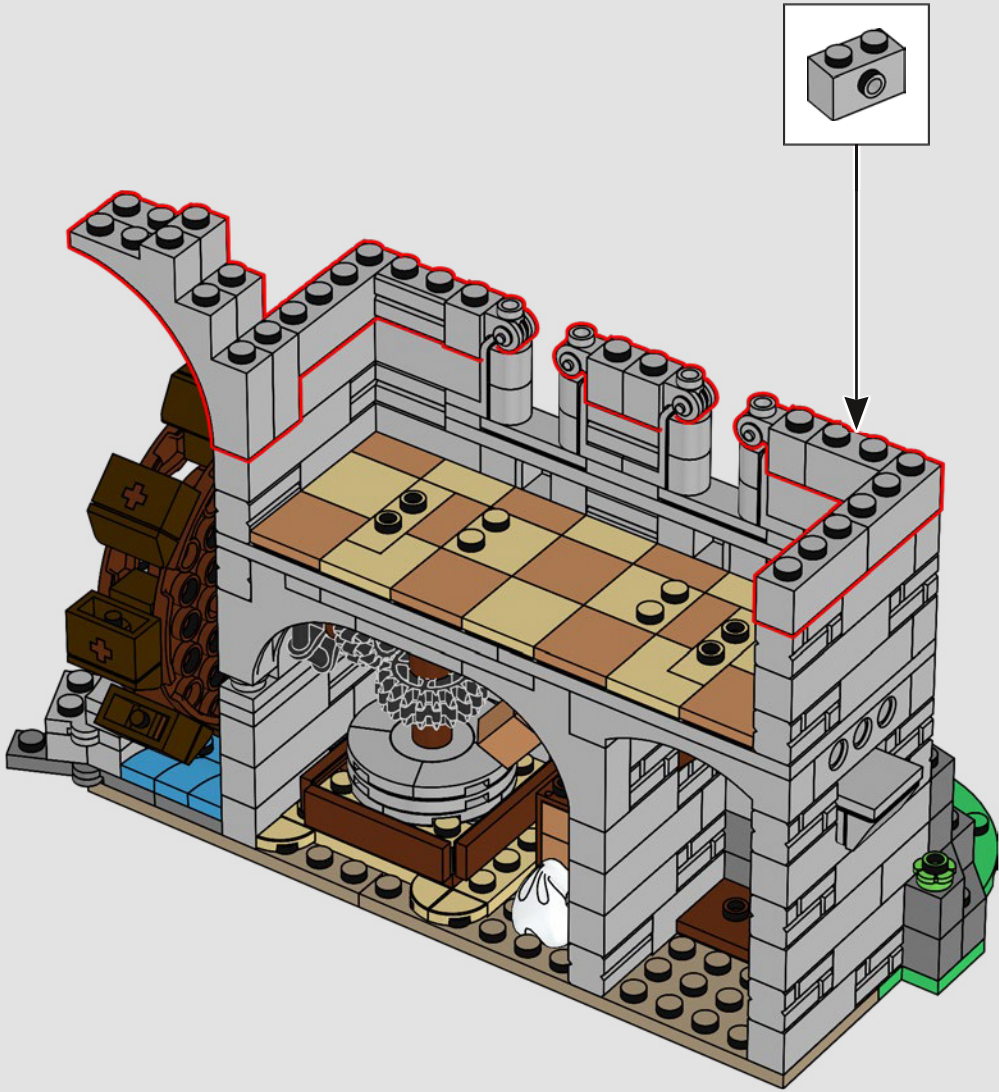

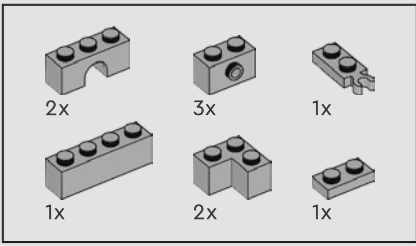

149

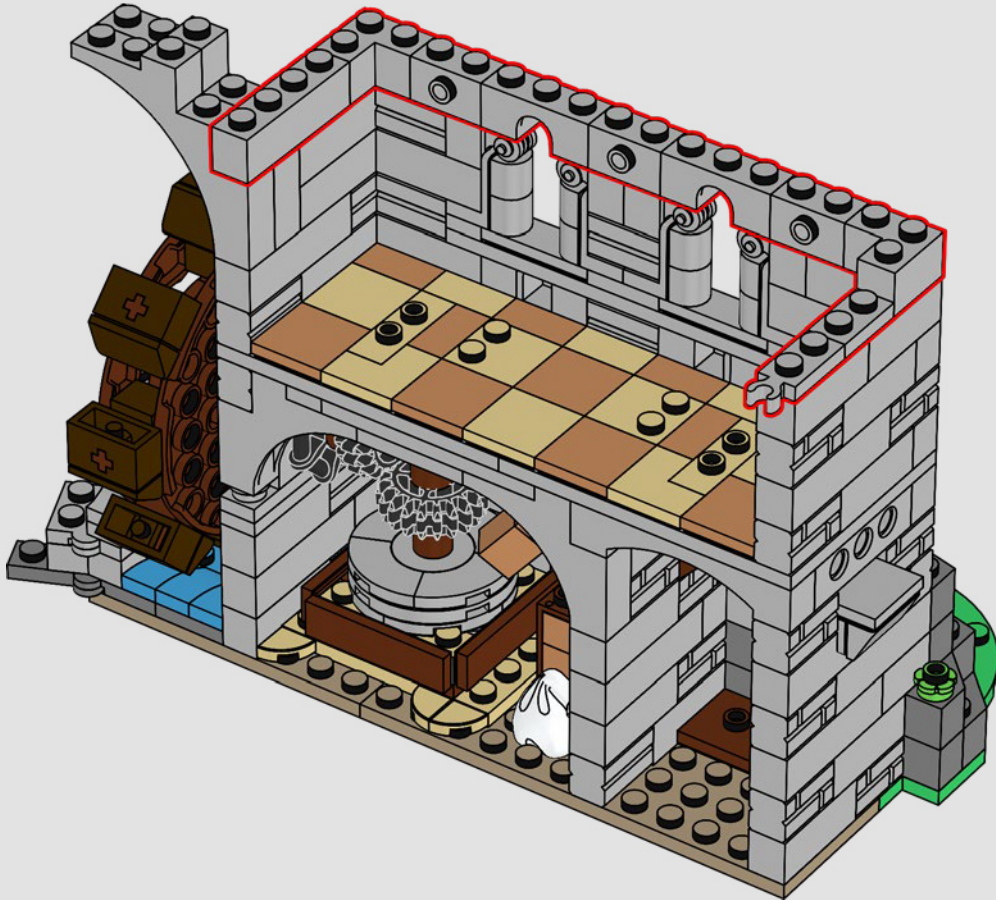

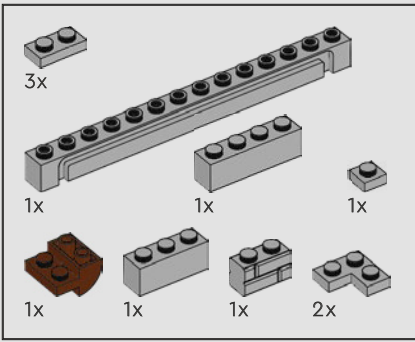

150

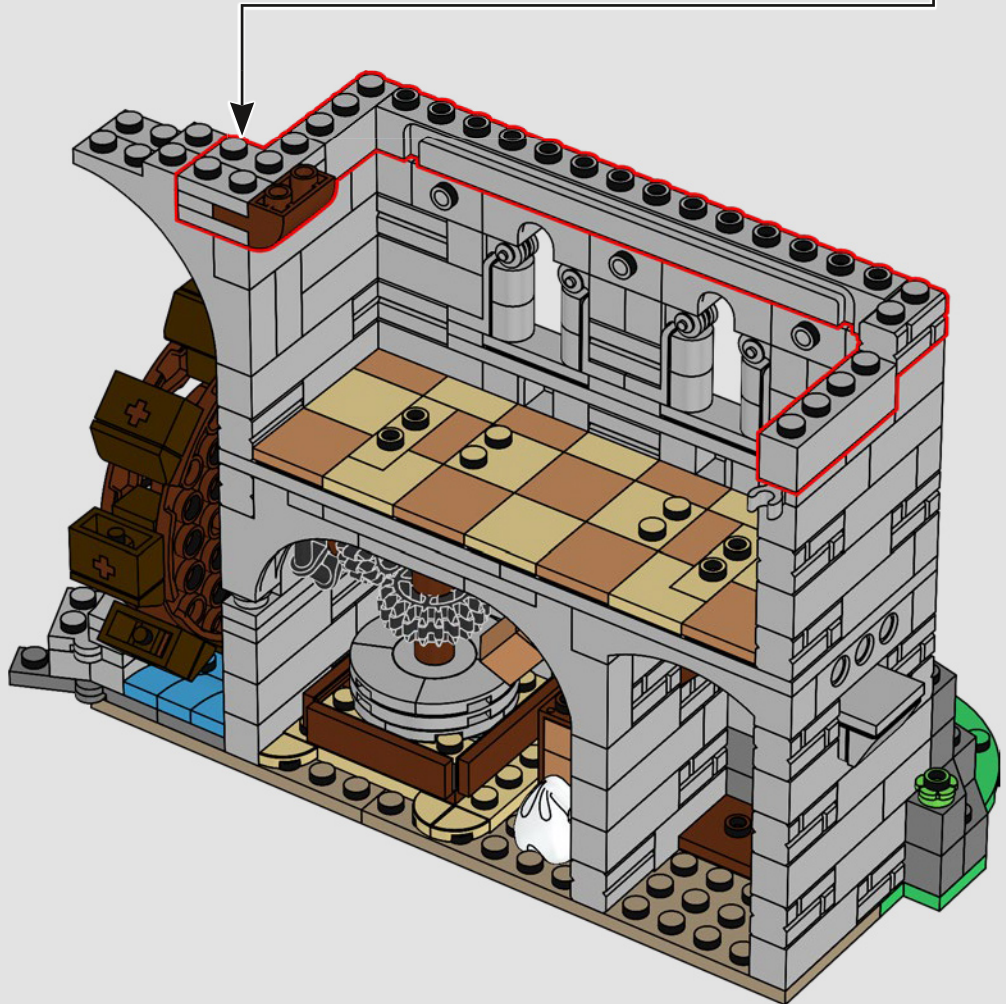
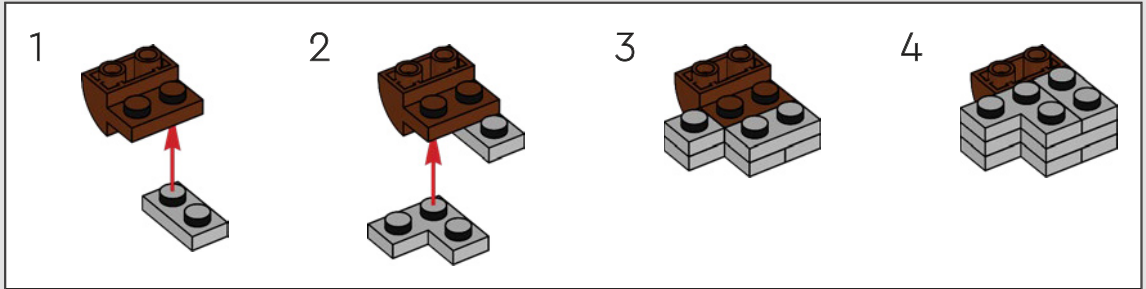

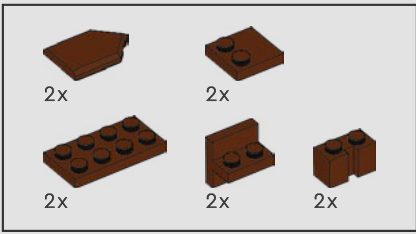

151

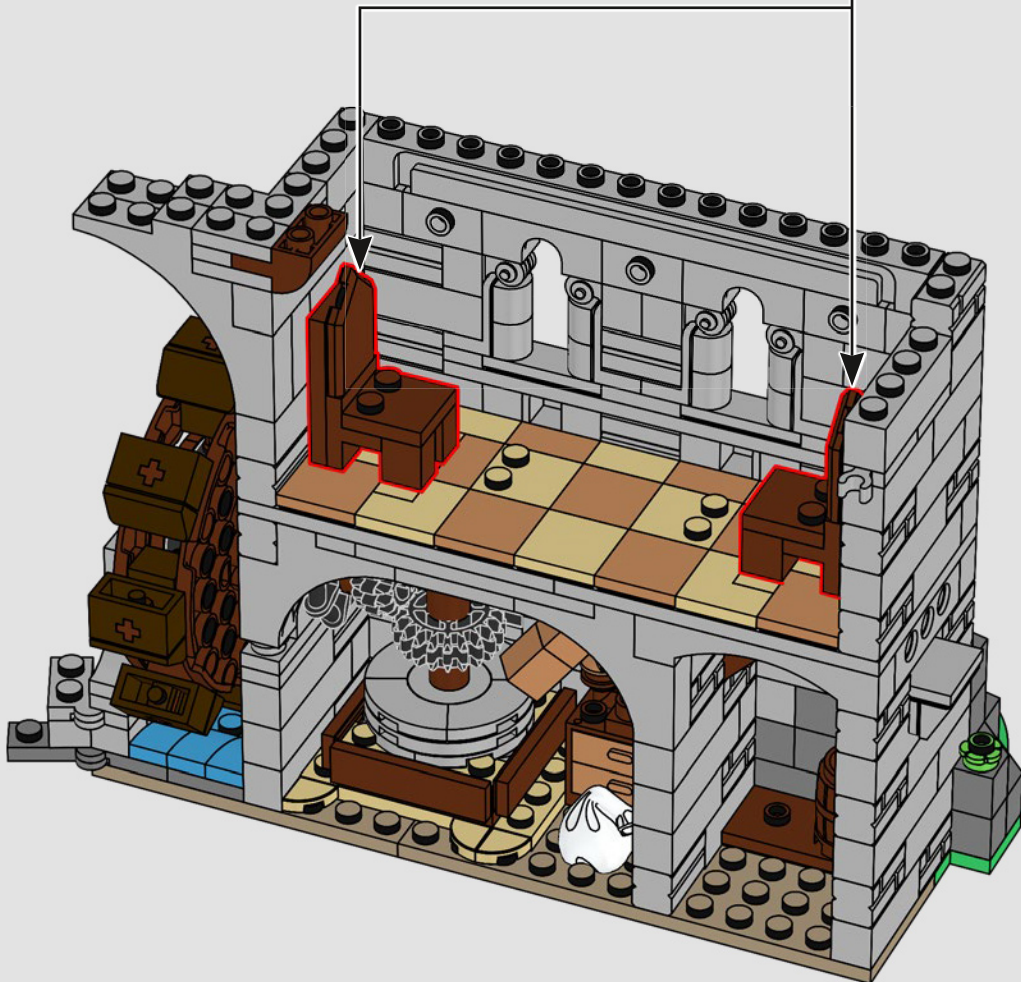
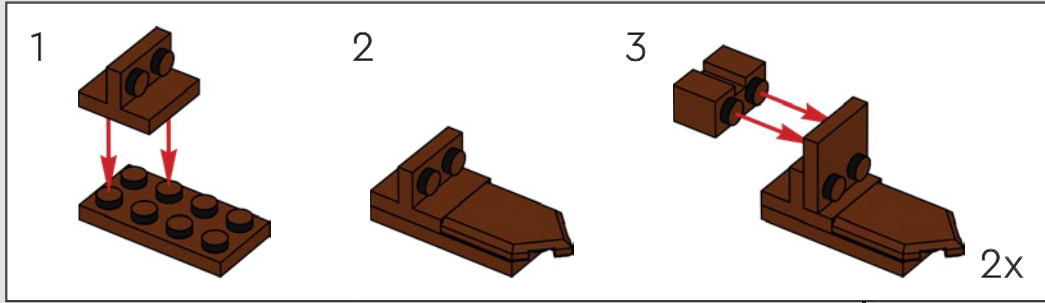



Le buffet est prêt, mais où est le festin ?

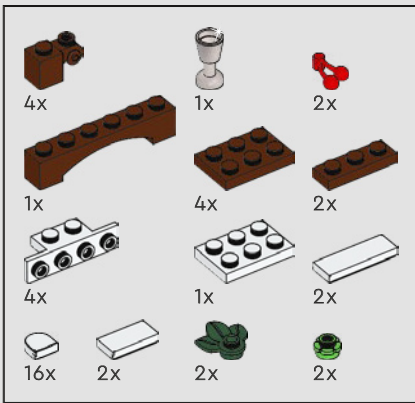
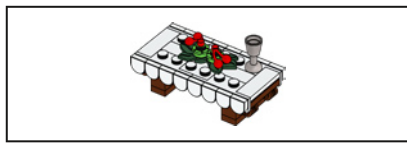

152

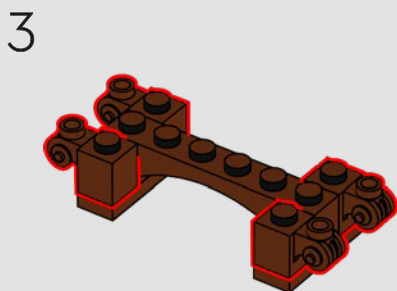
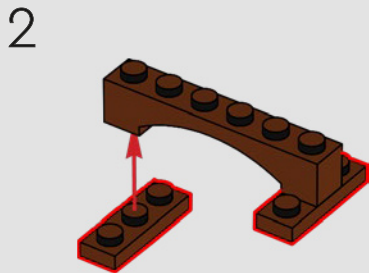
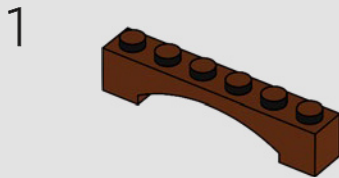

4

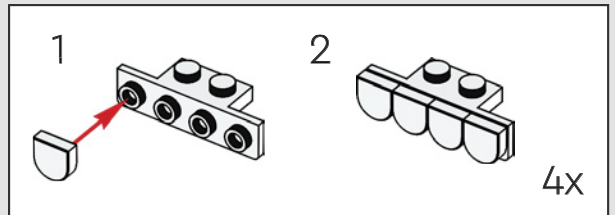
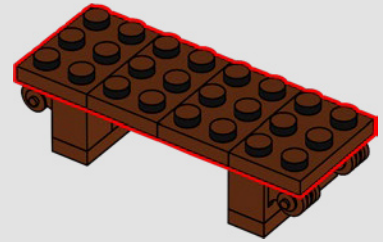

5

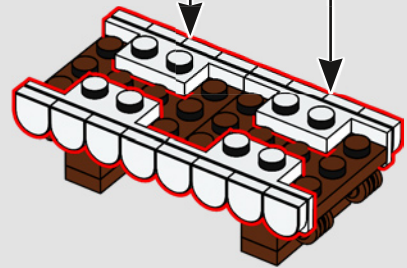

6

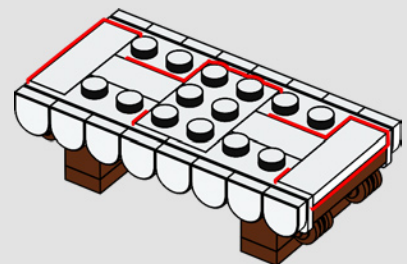

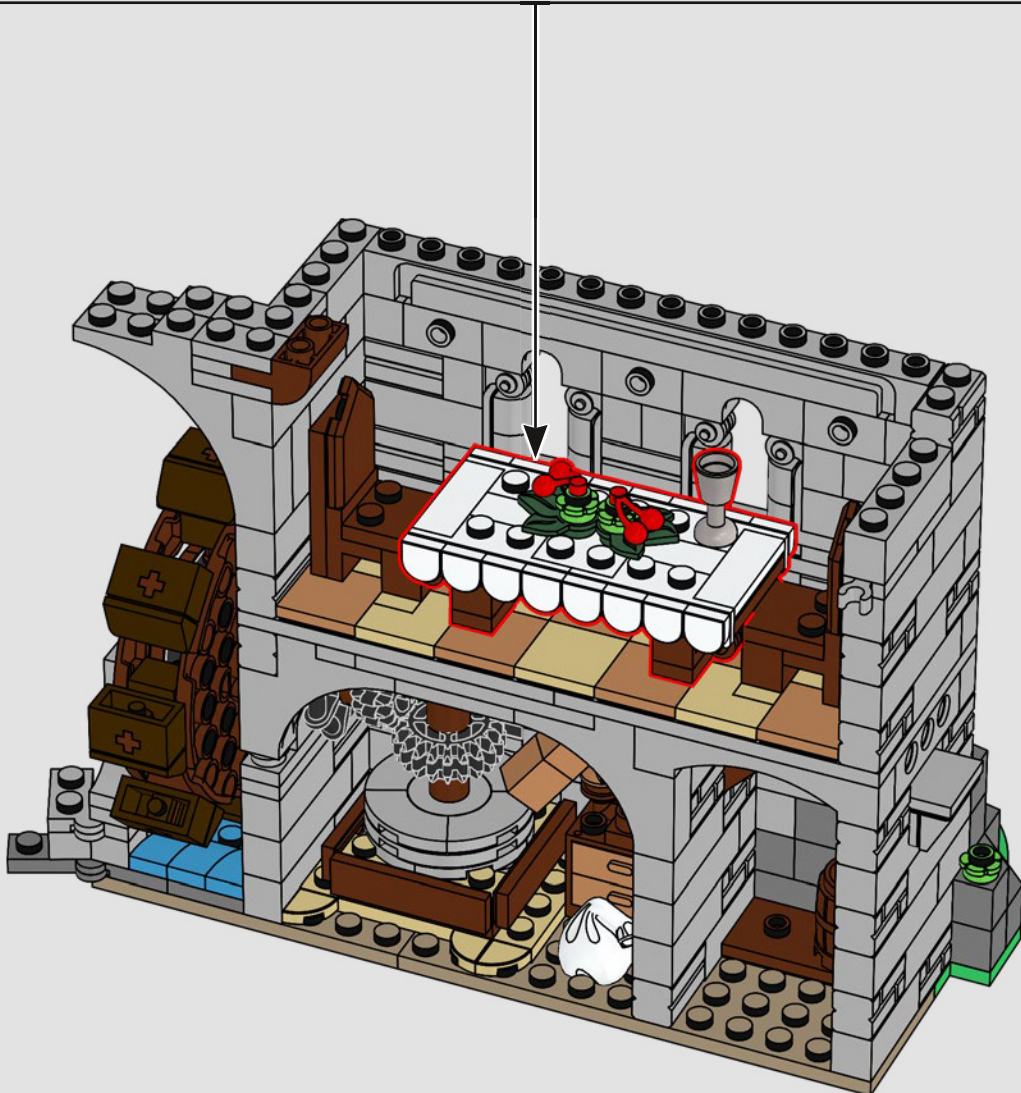
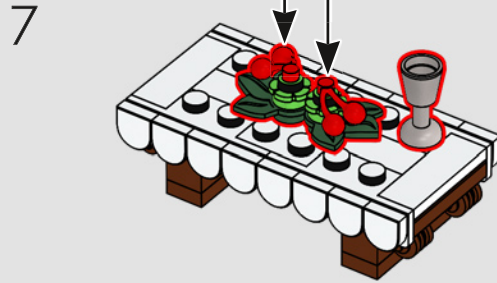
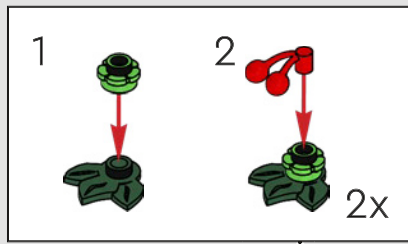

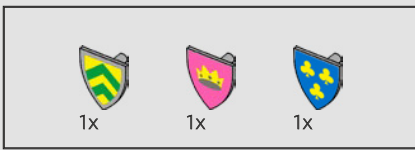

Quelle belle teinte de rose. Cette armoire d'antan évoque une époque plus simple...

153



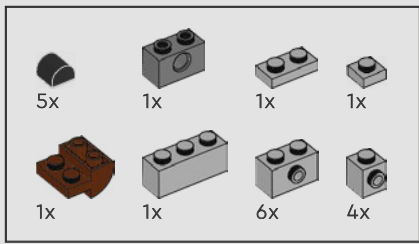

154

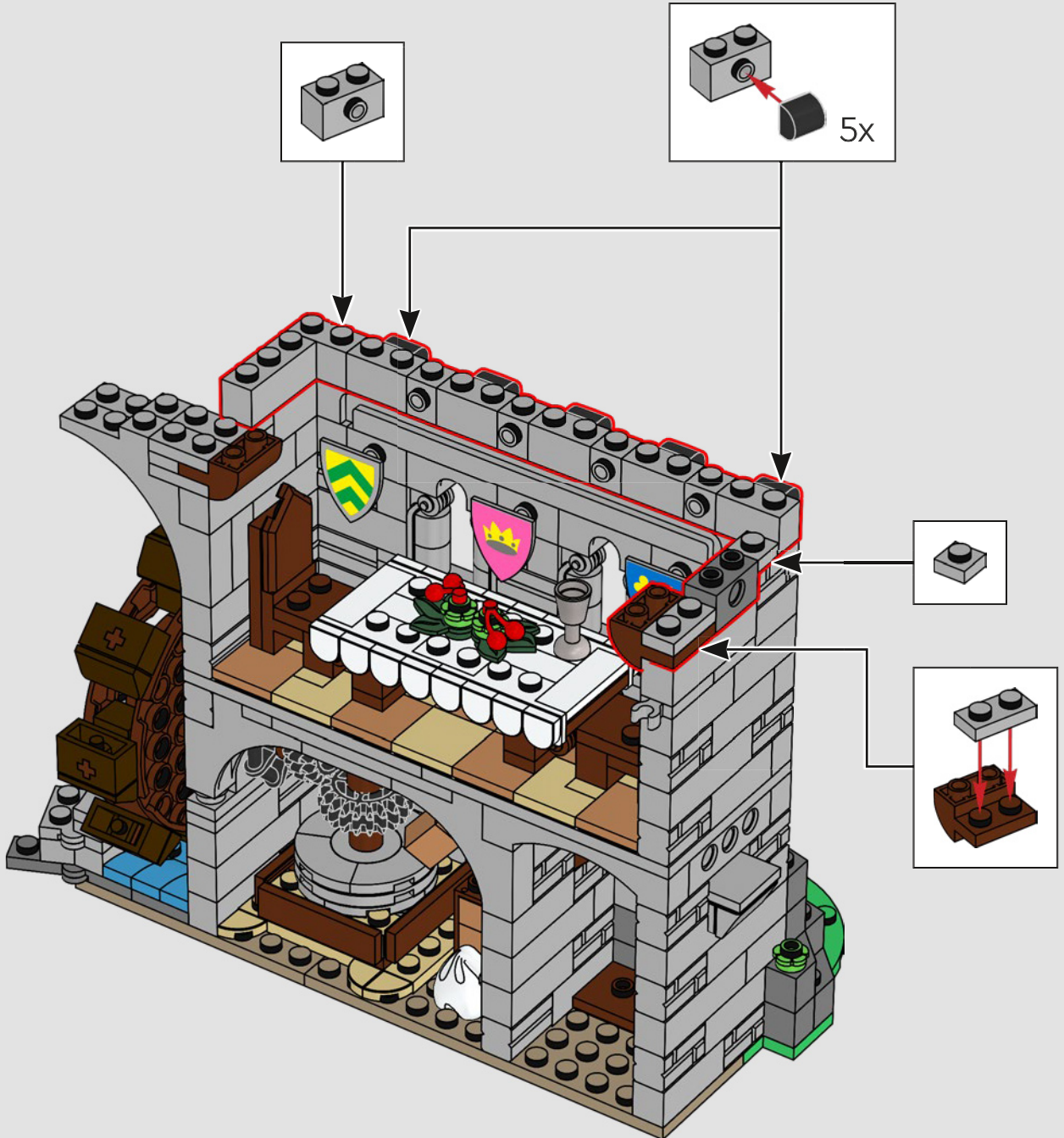

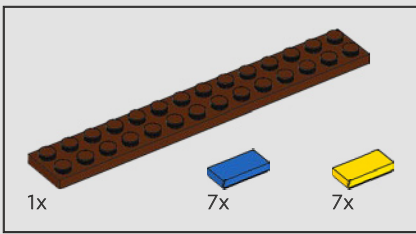

155

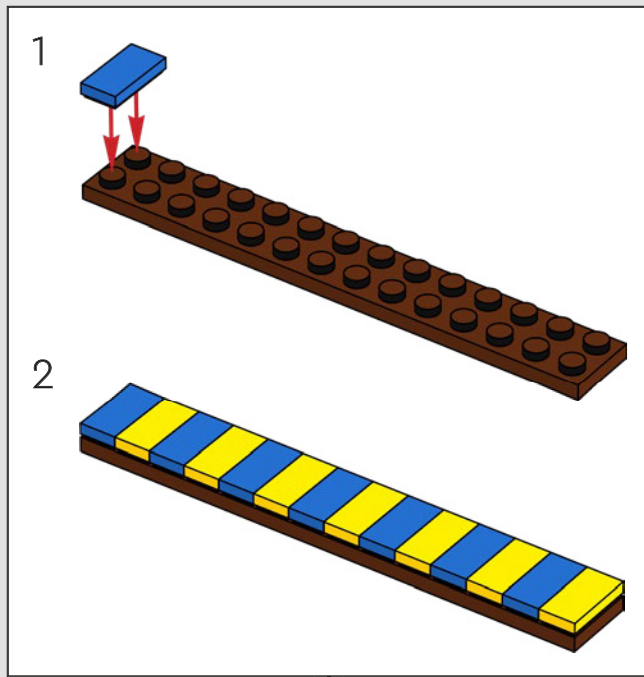

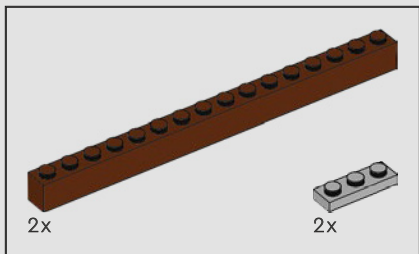

156

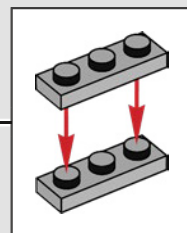

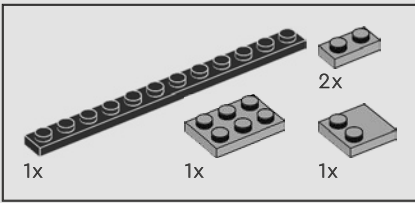

157

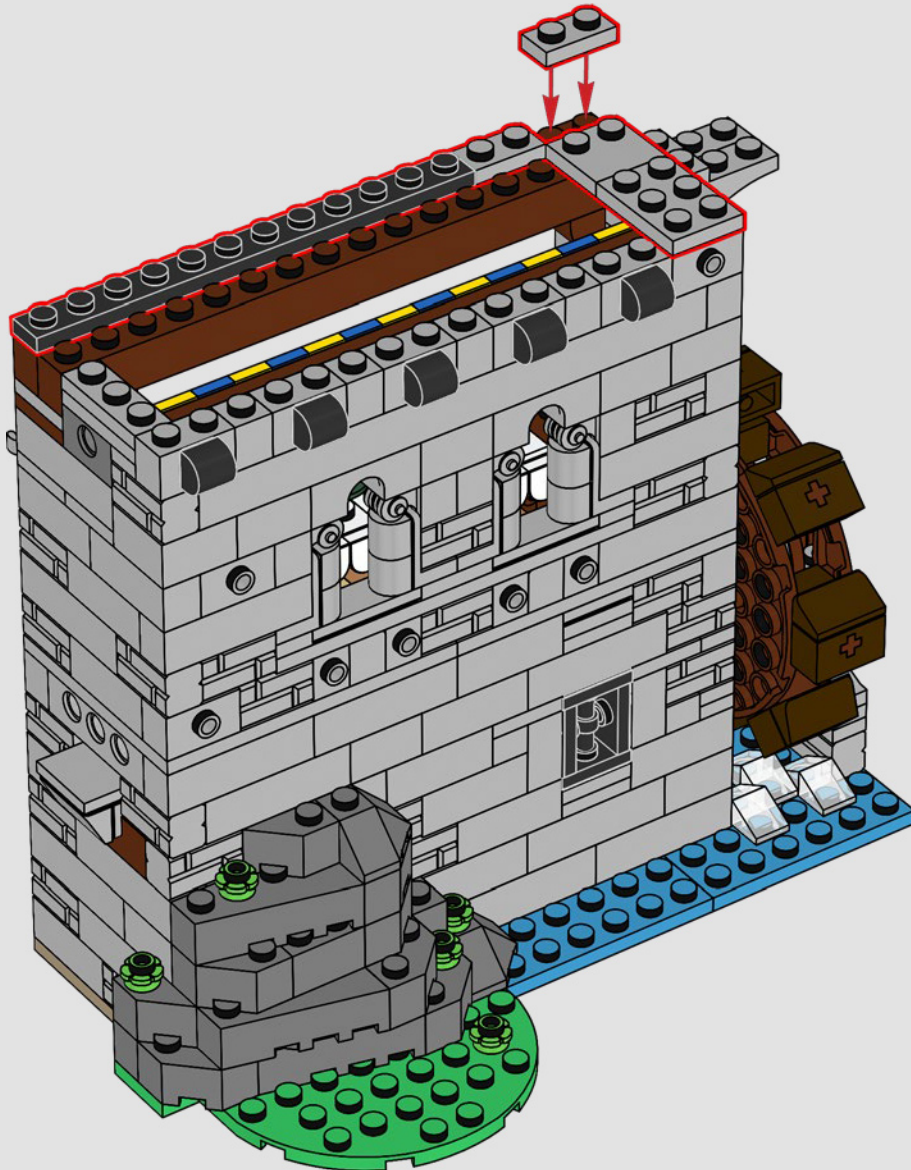

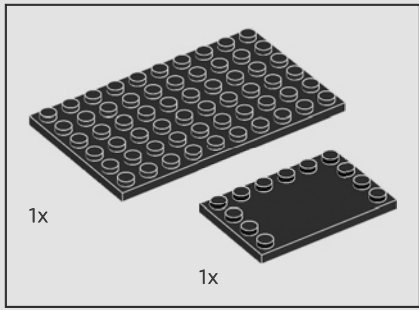

158

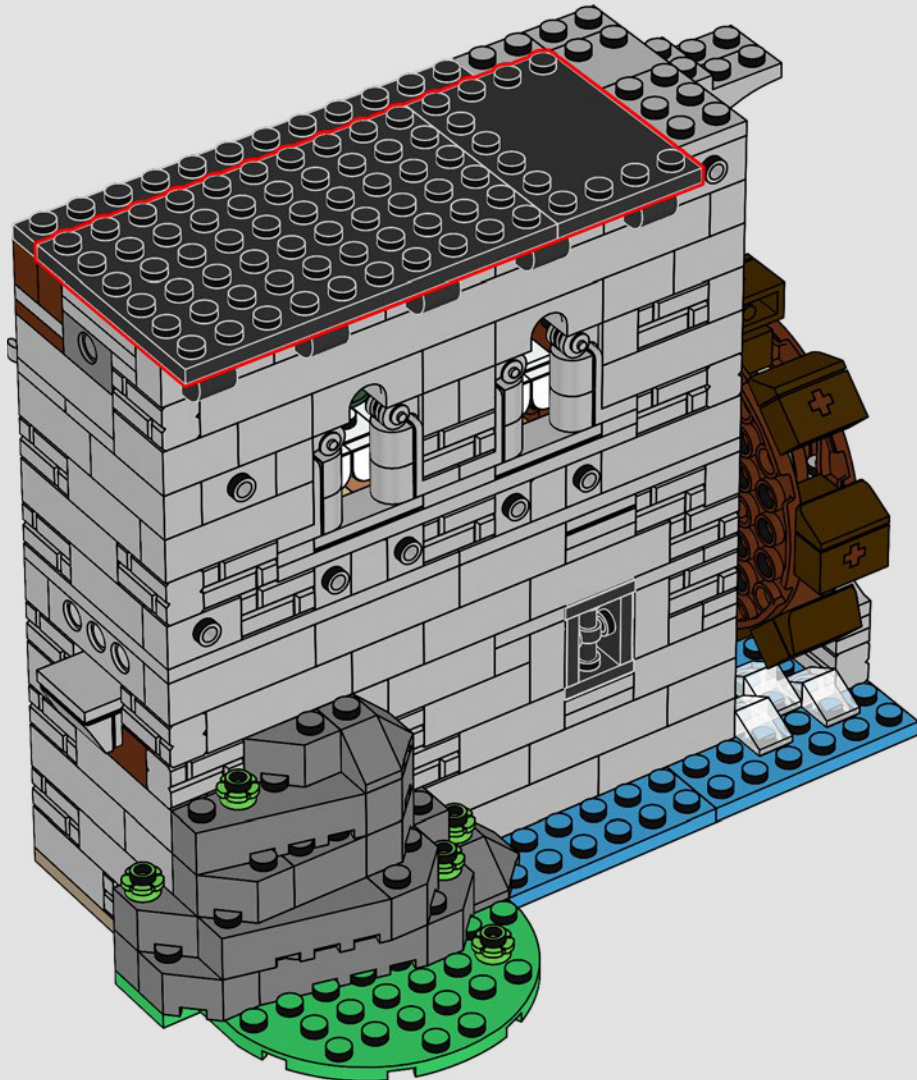



159

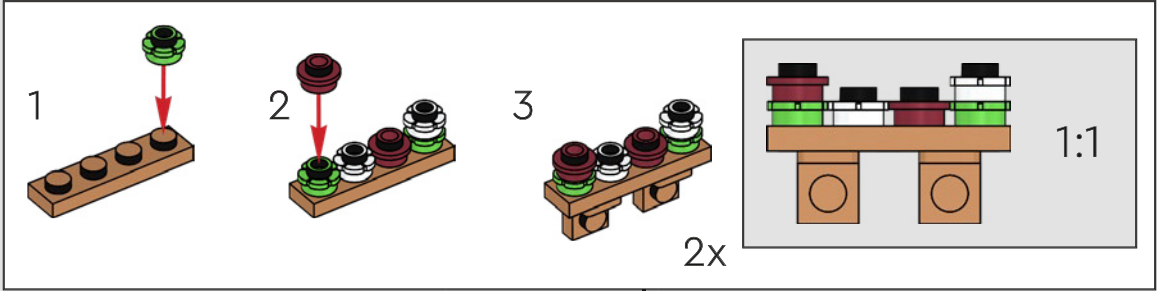

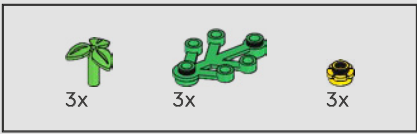

160

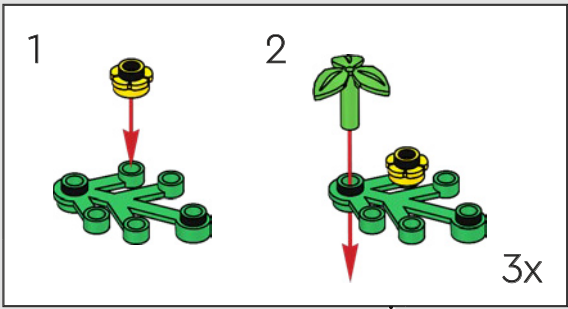

161

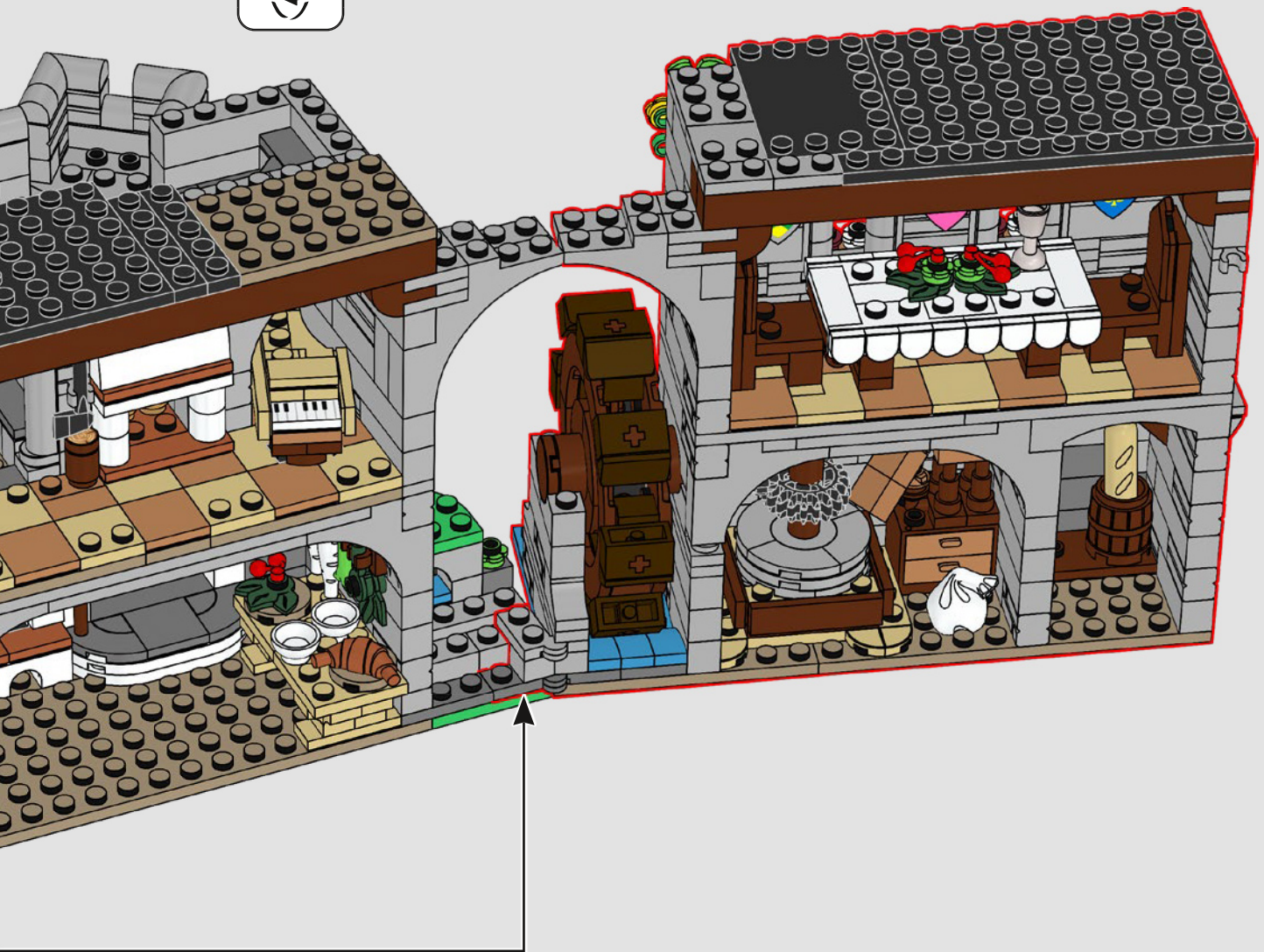

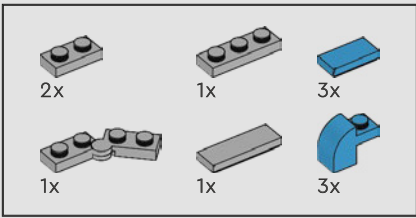

162

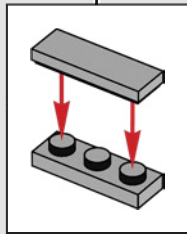
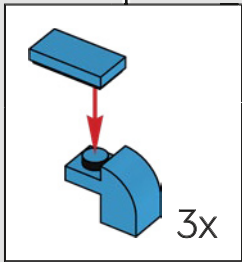
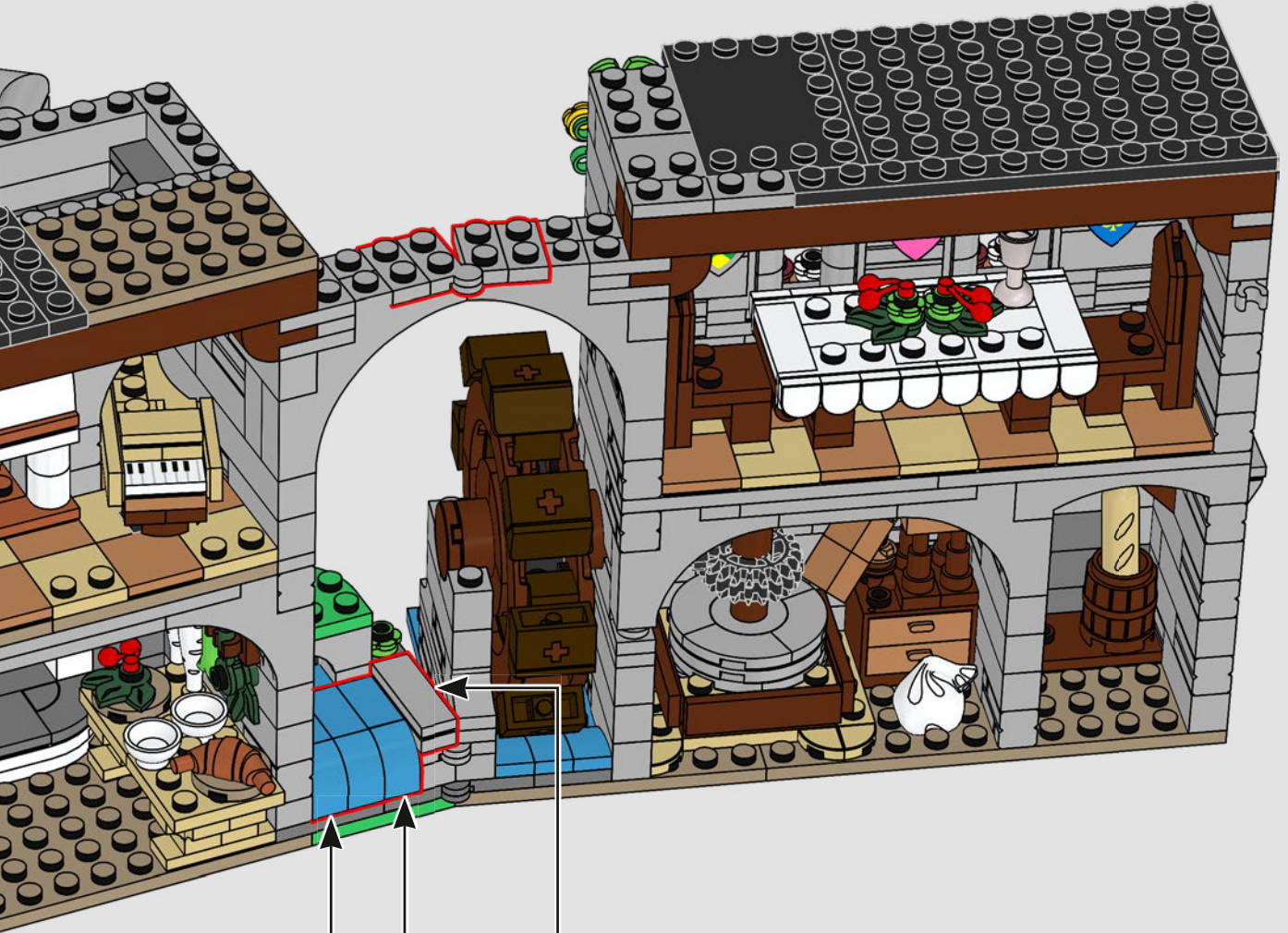

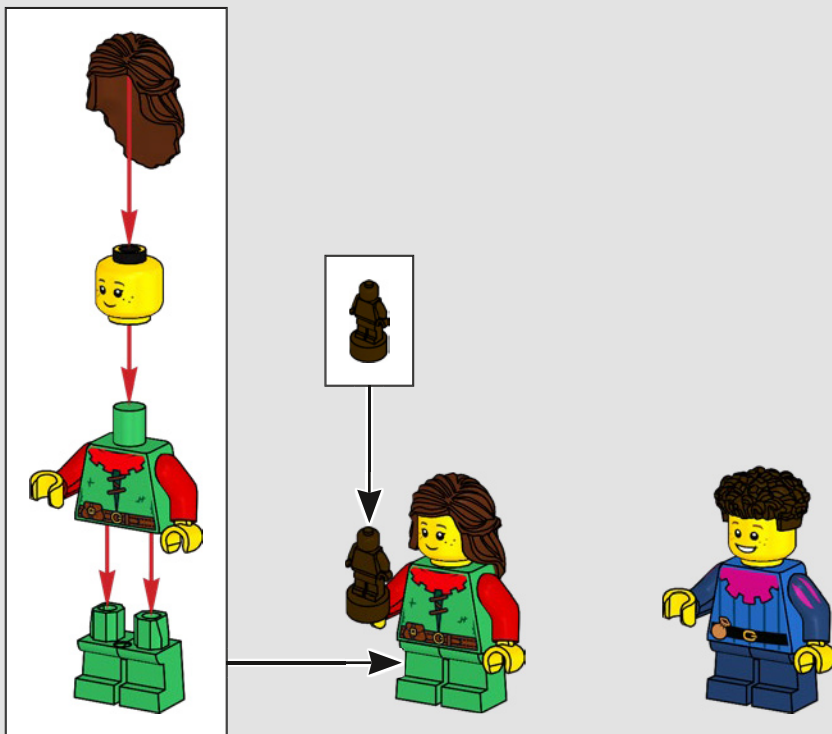

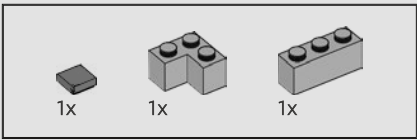

163

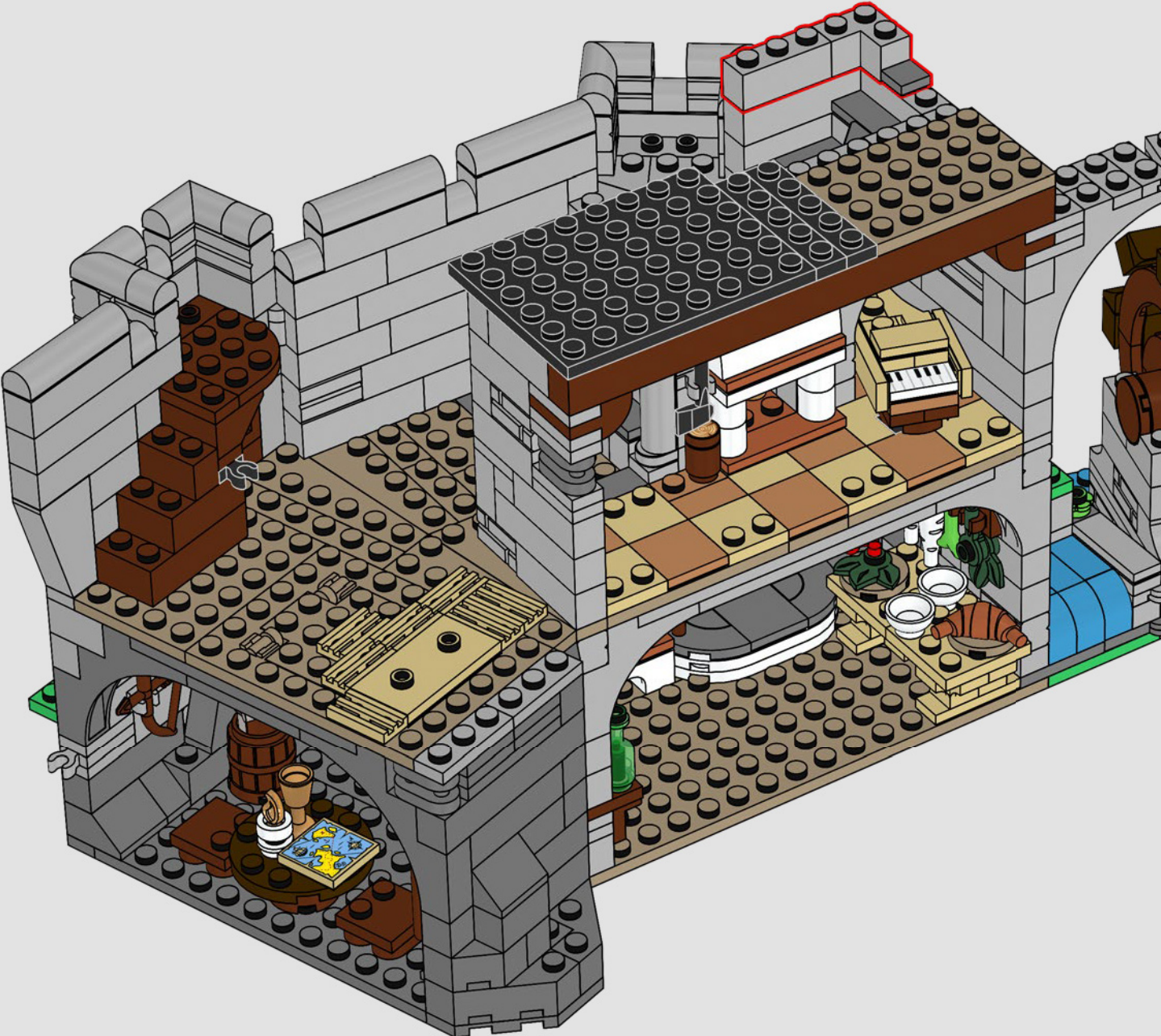

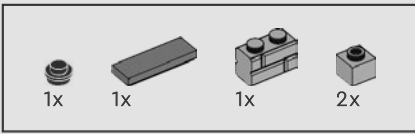

164

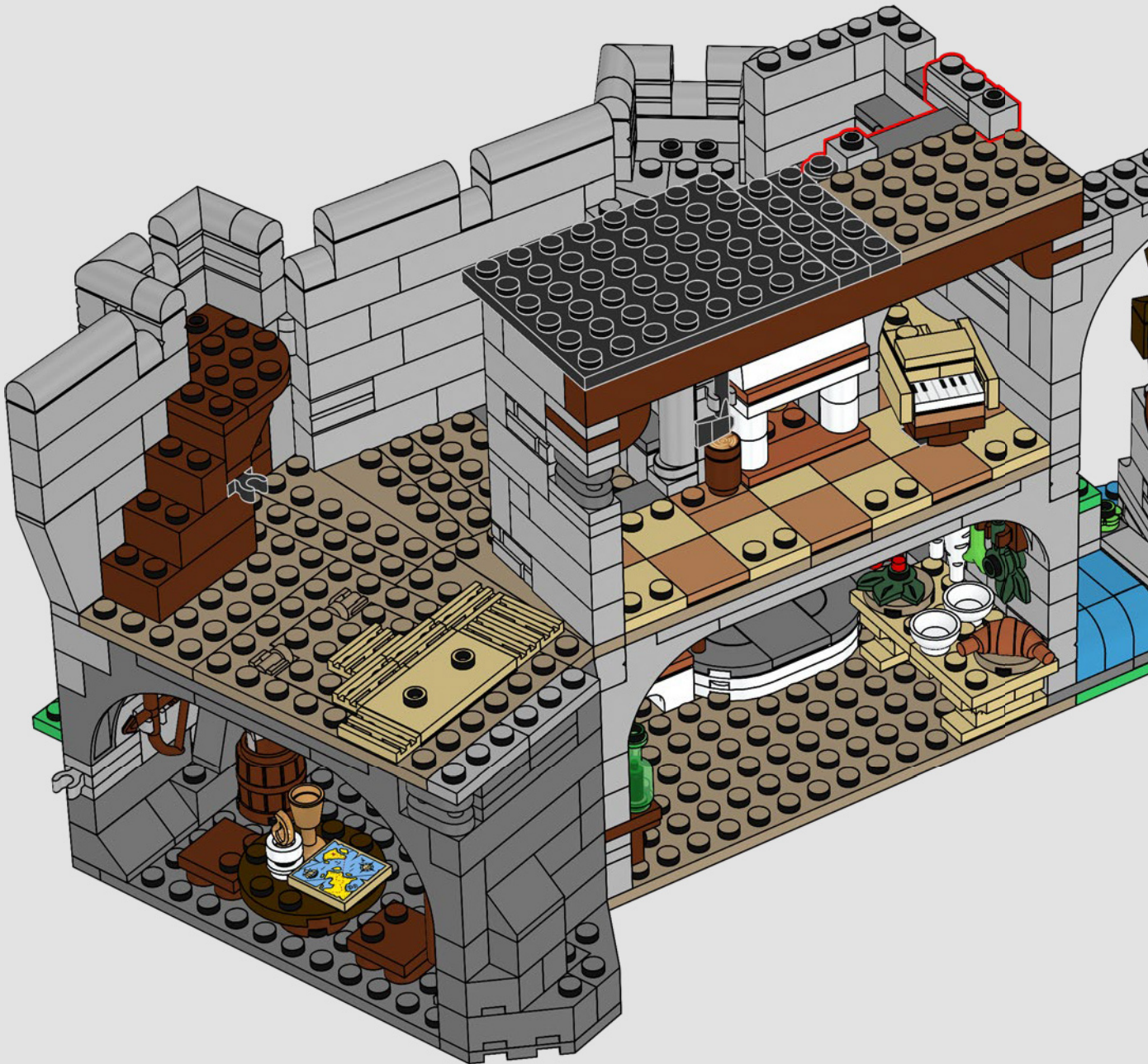

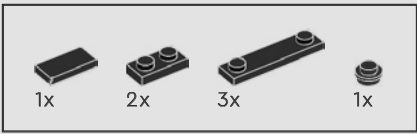

165



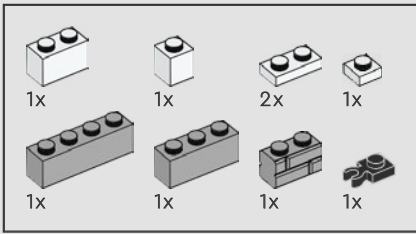

166

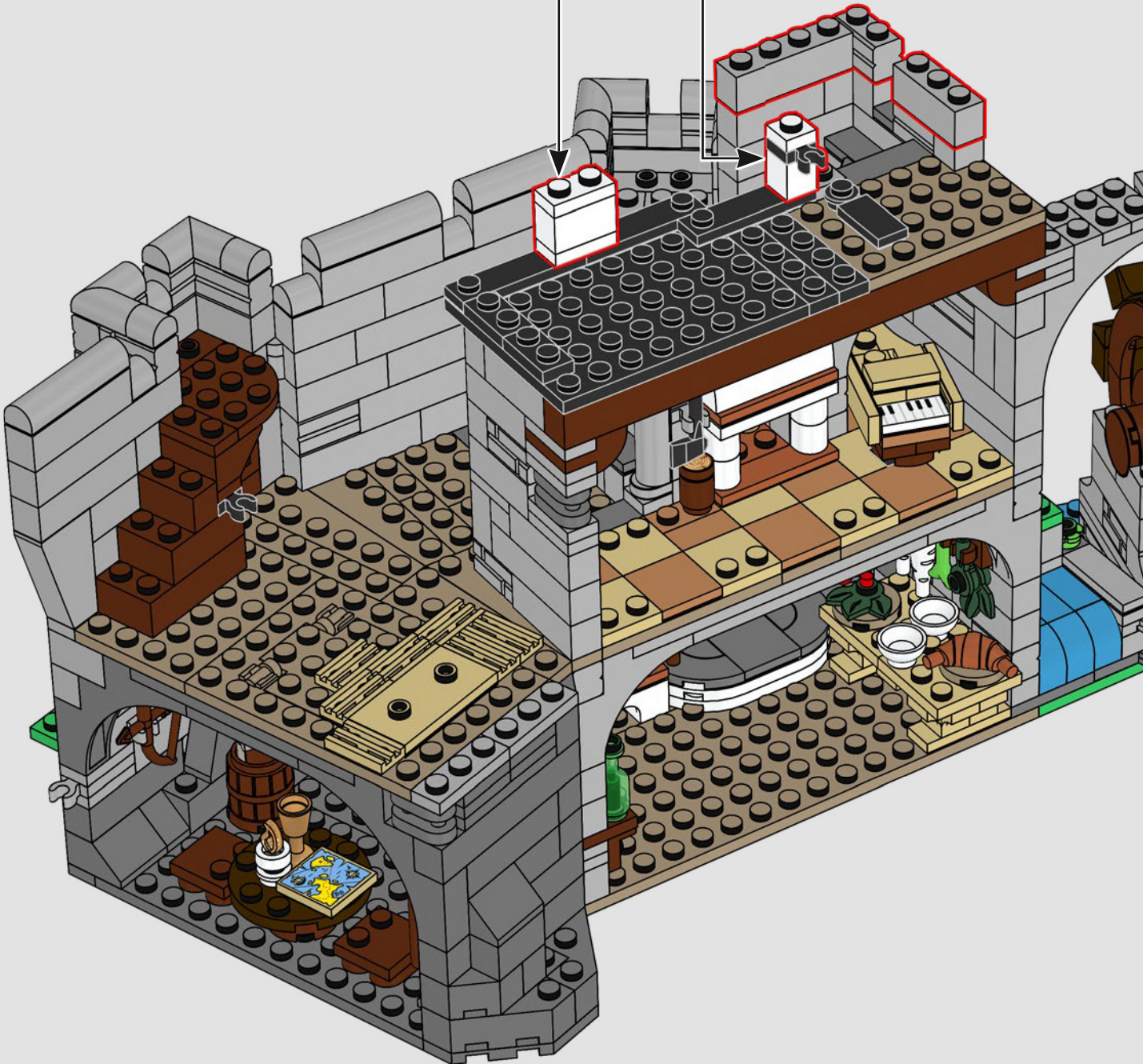
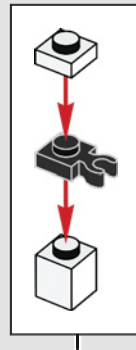
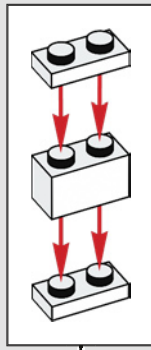

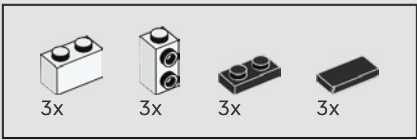

167

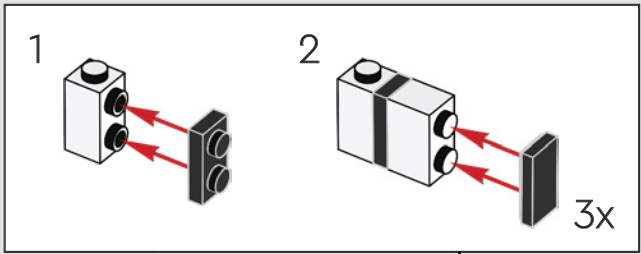

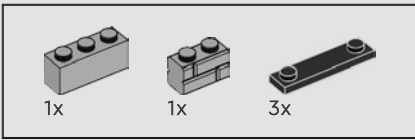

168

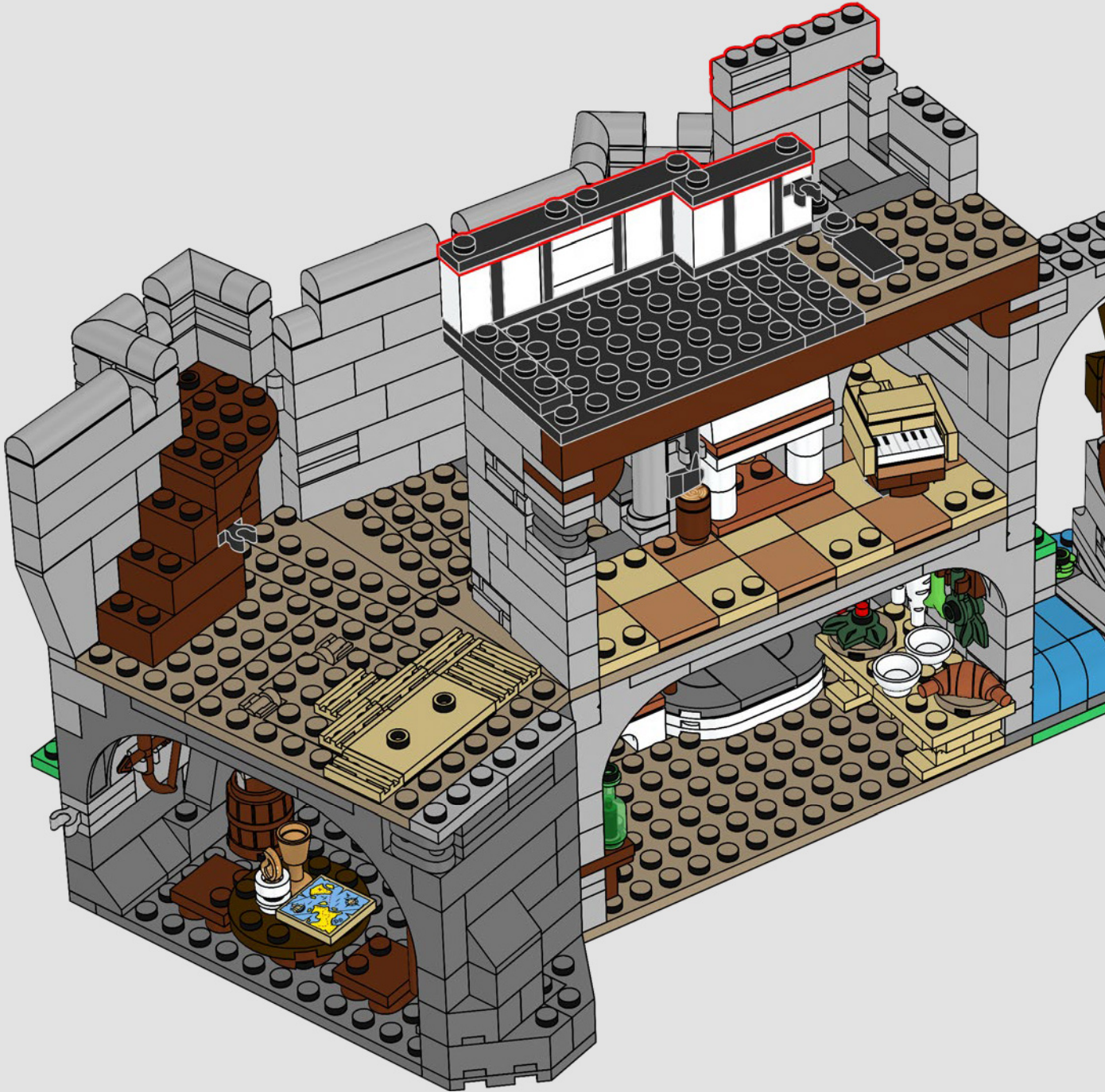

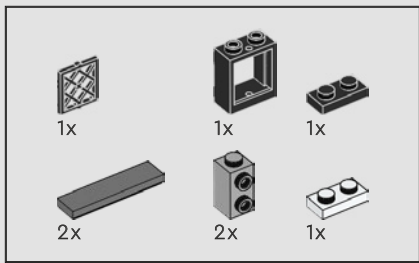

169

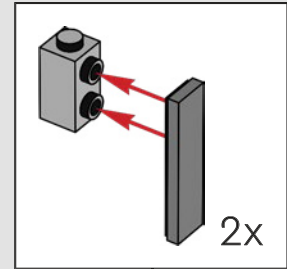
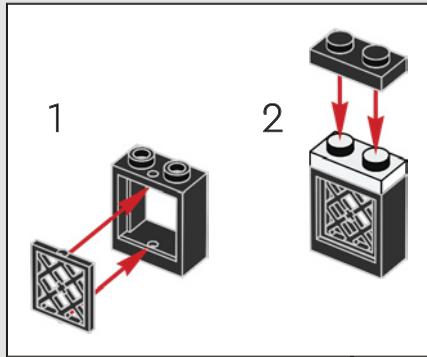

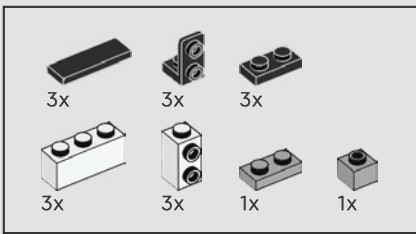

170

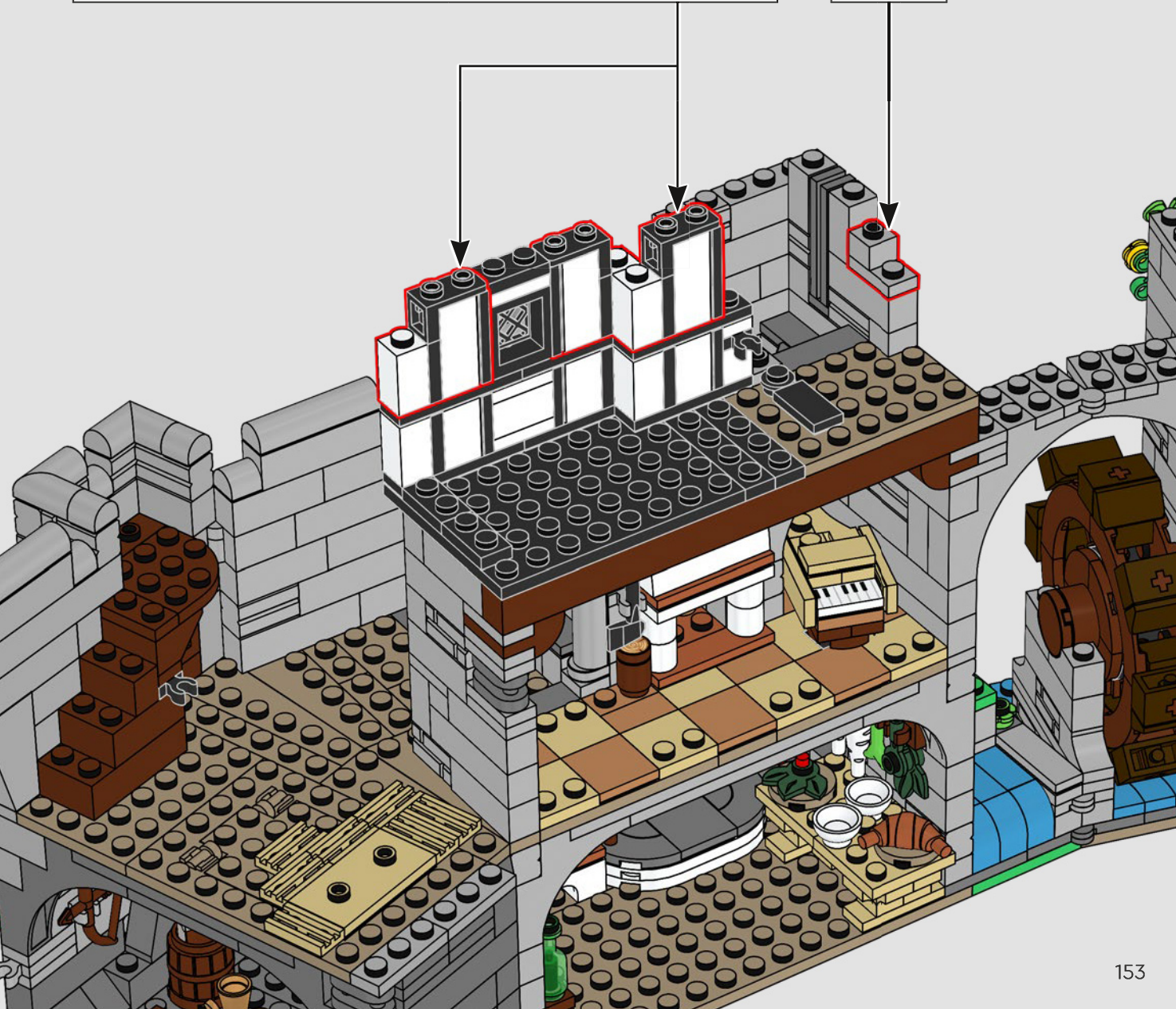
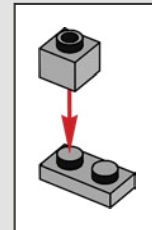
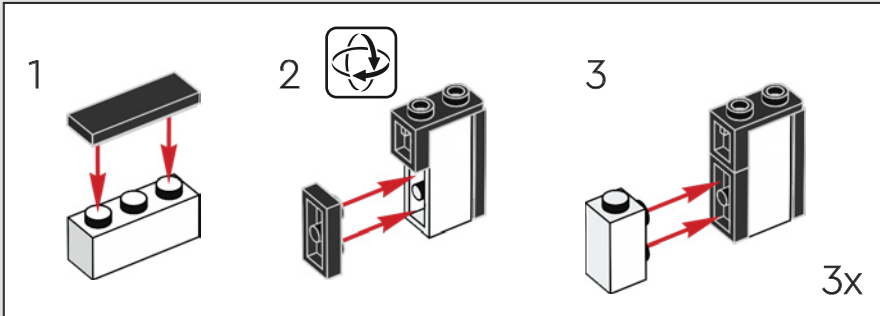

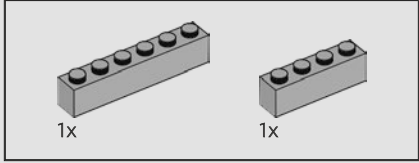
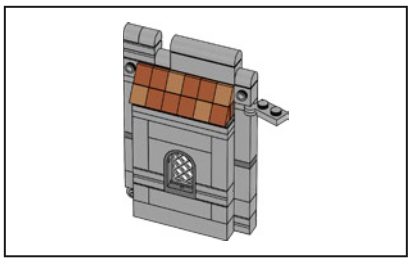

171

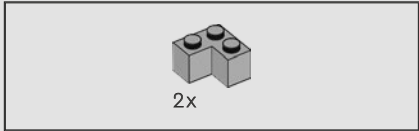
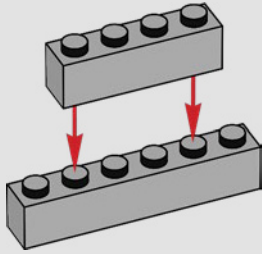

172

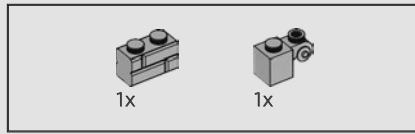
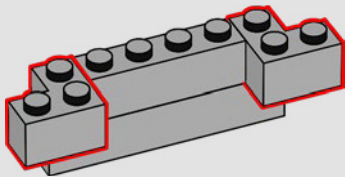

173

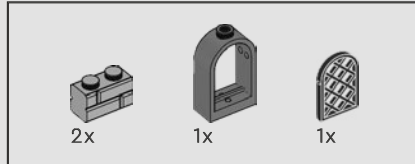
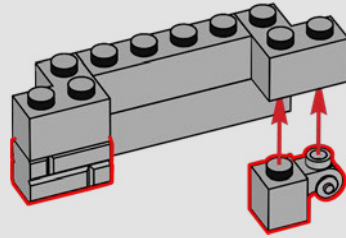

174

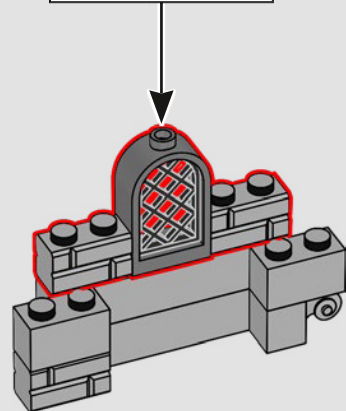
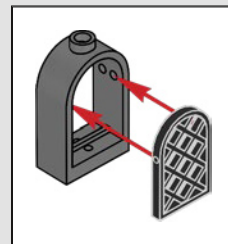

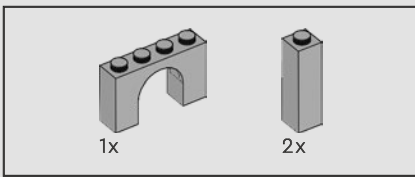

175

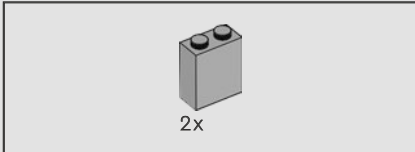
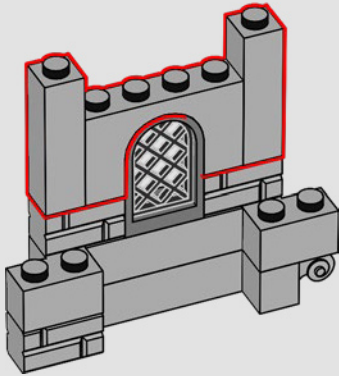

176

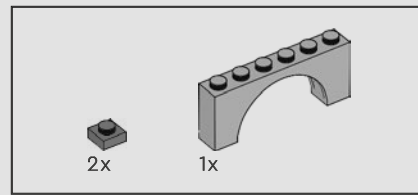
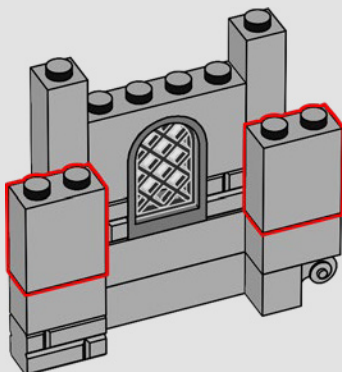

177

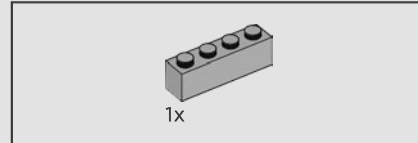
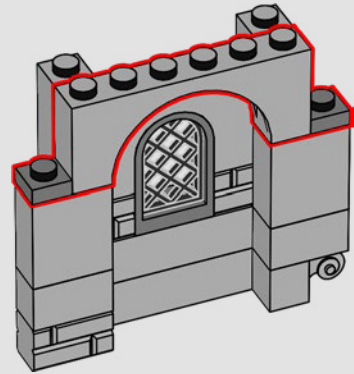

178

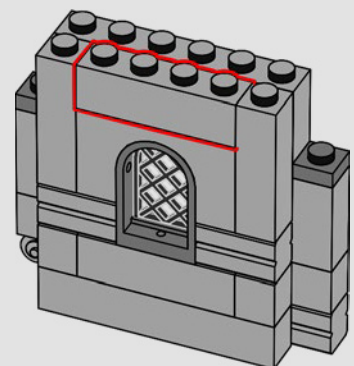

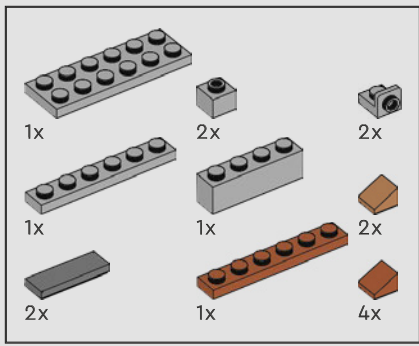

179

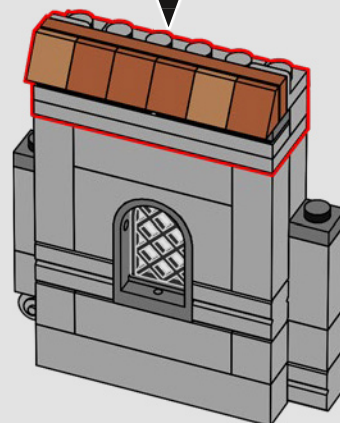
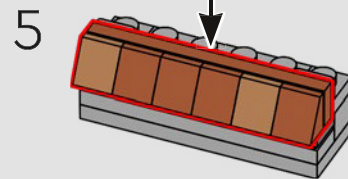
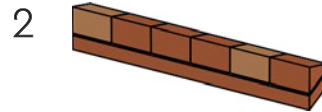
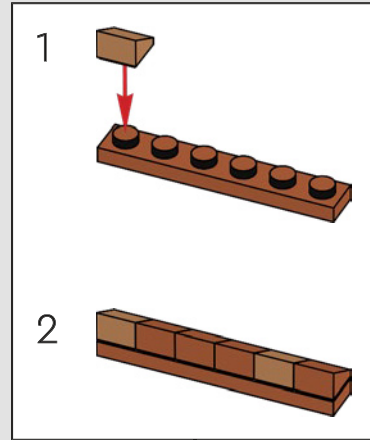
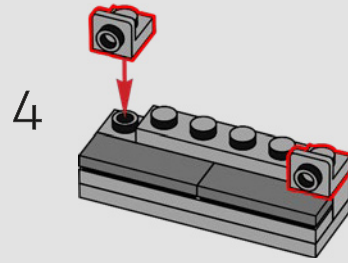
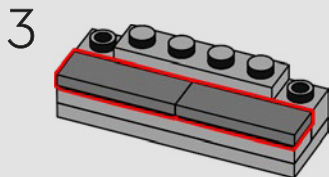
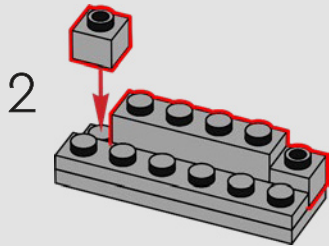
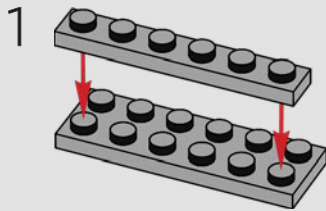

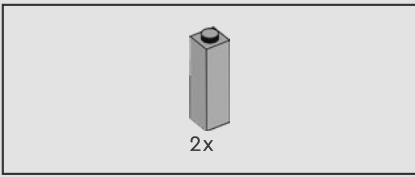

180

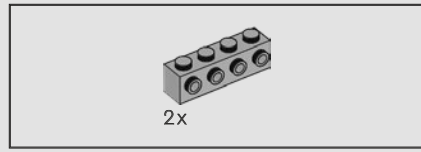
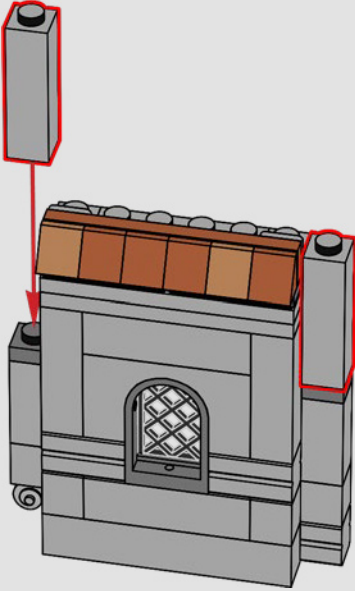

182

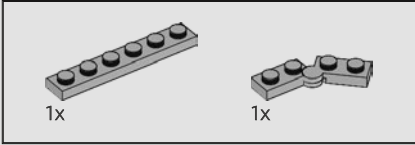
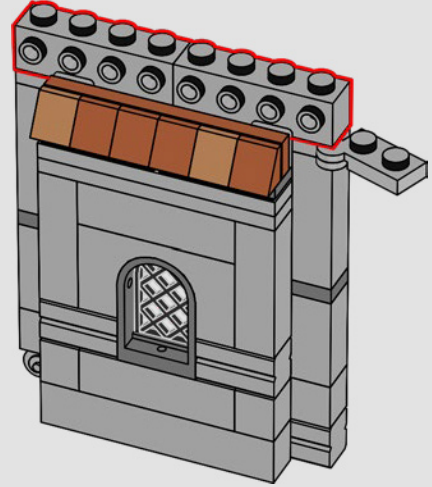

181

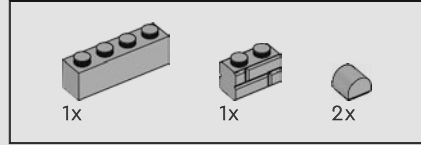
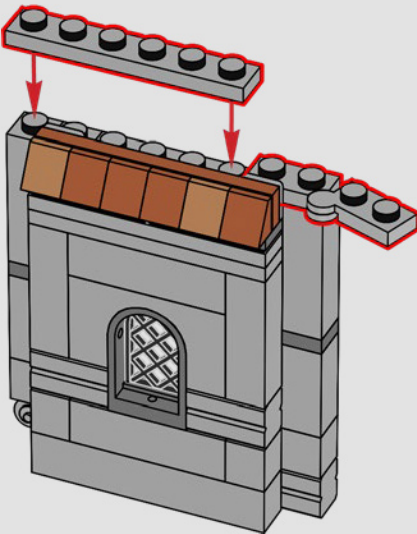

183

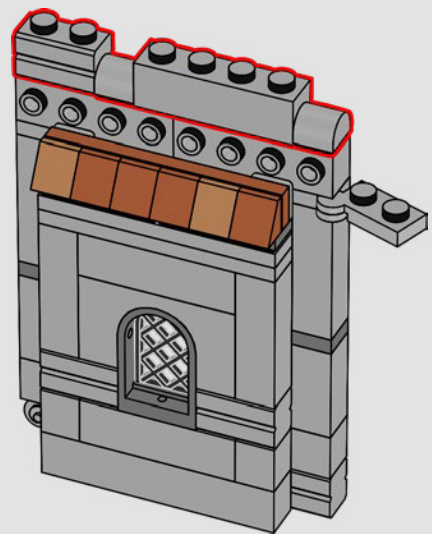

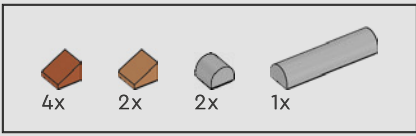

184

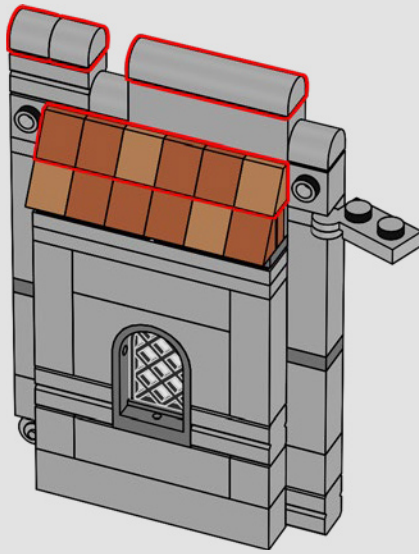

185



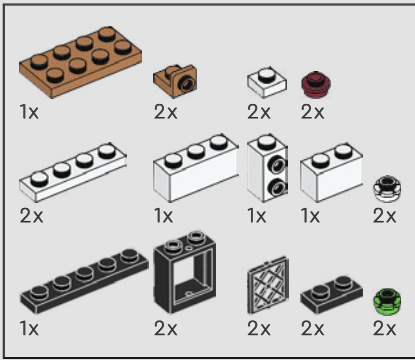
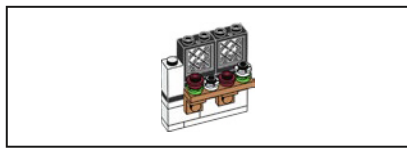

186

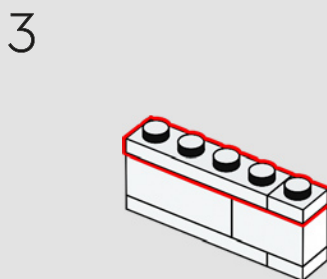
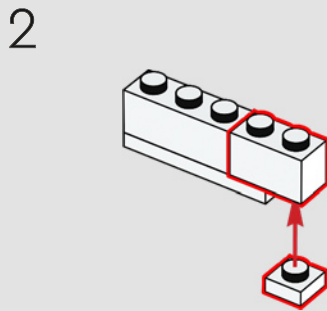
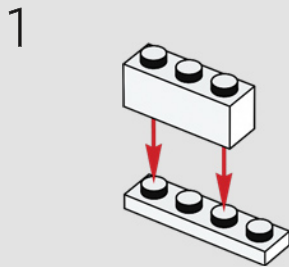

4

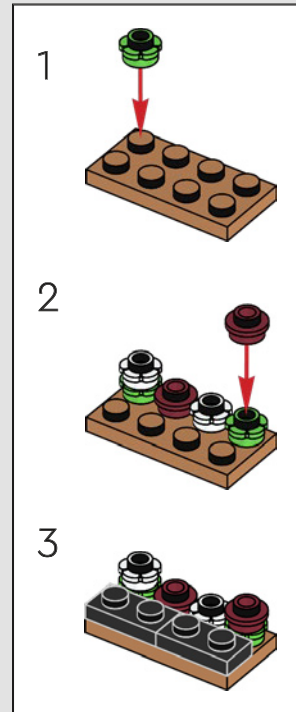
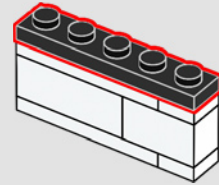

5

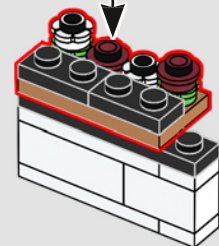

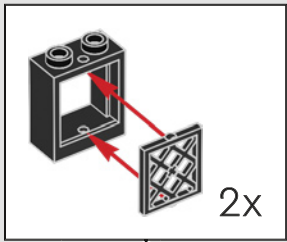

6

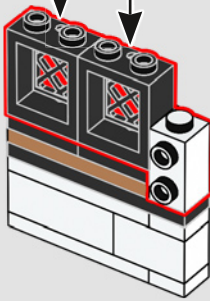

7

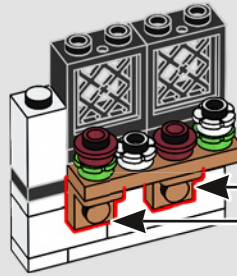

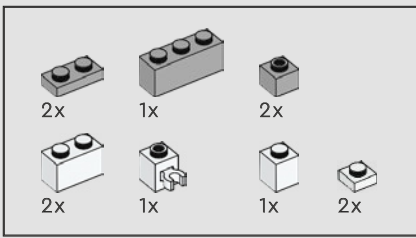

187

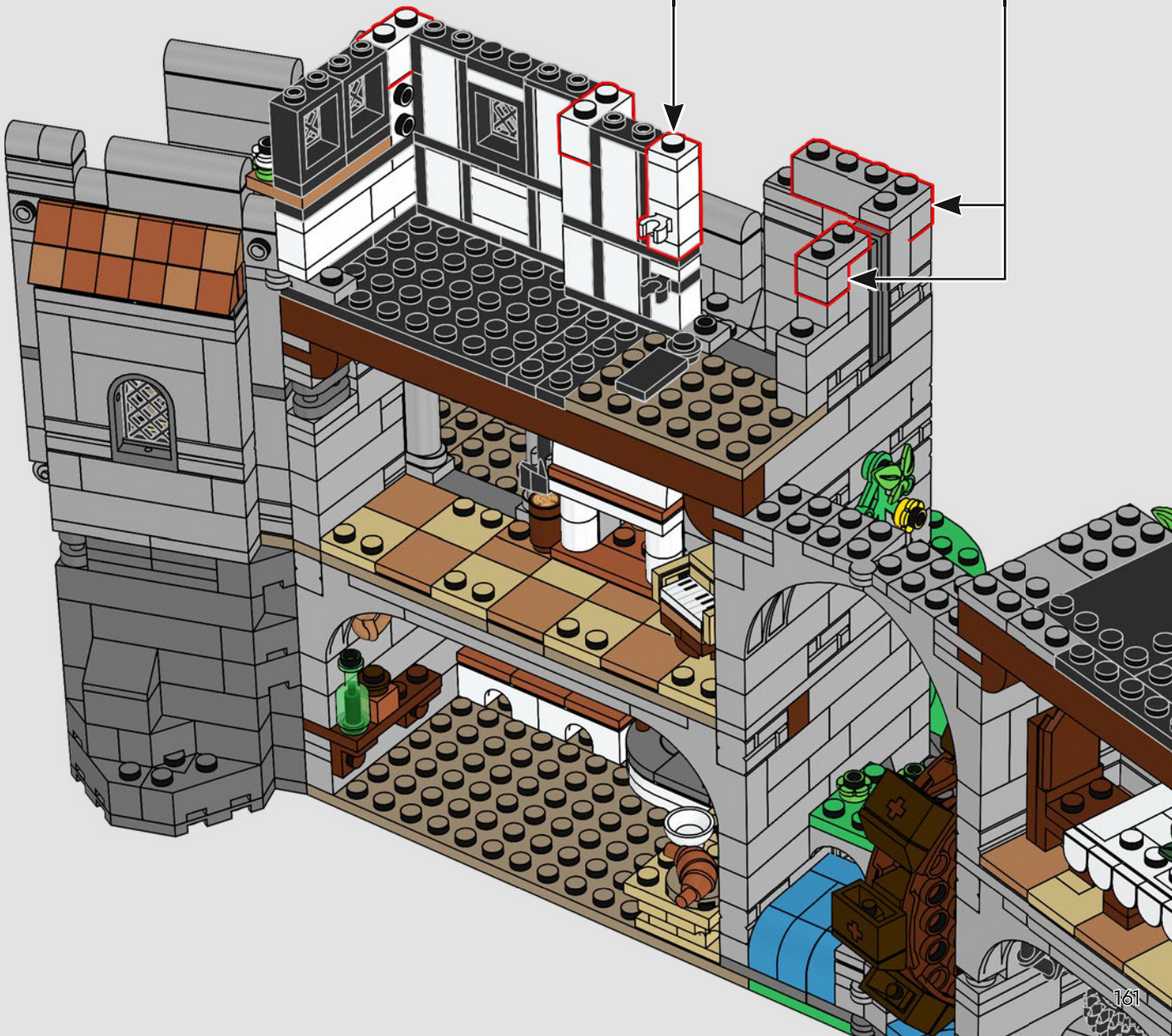
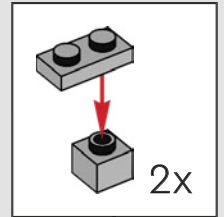
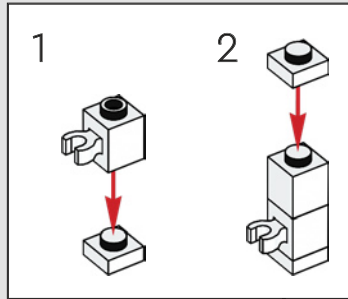

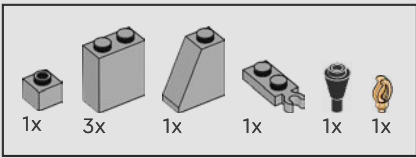

188

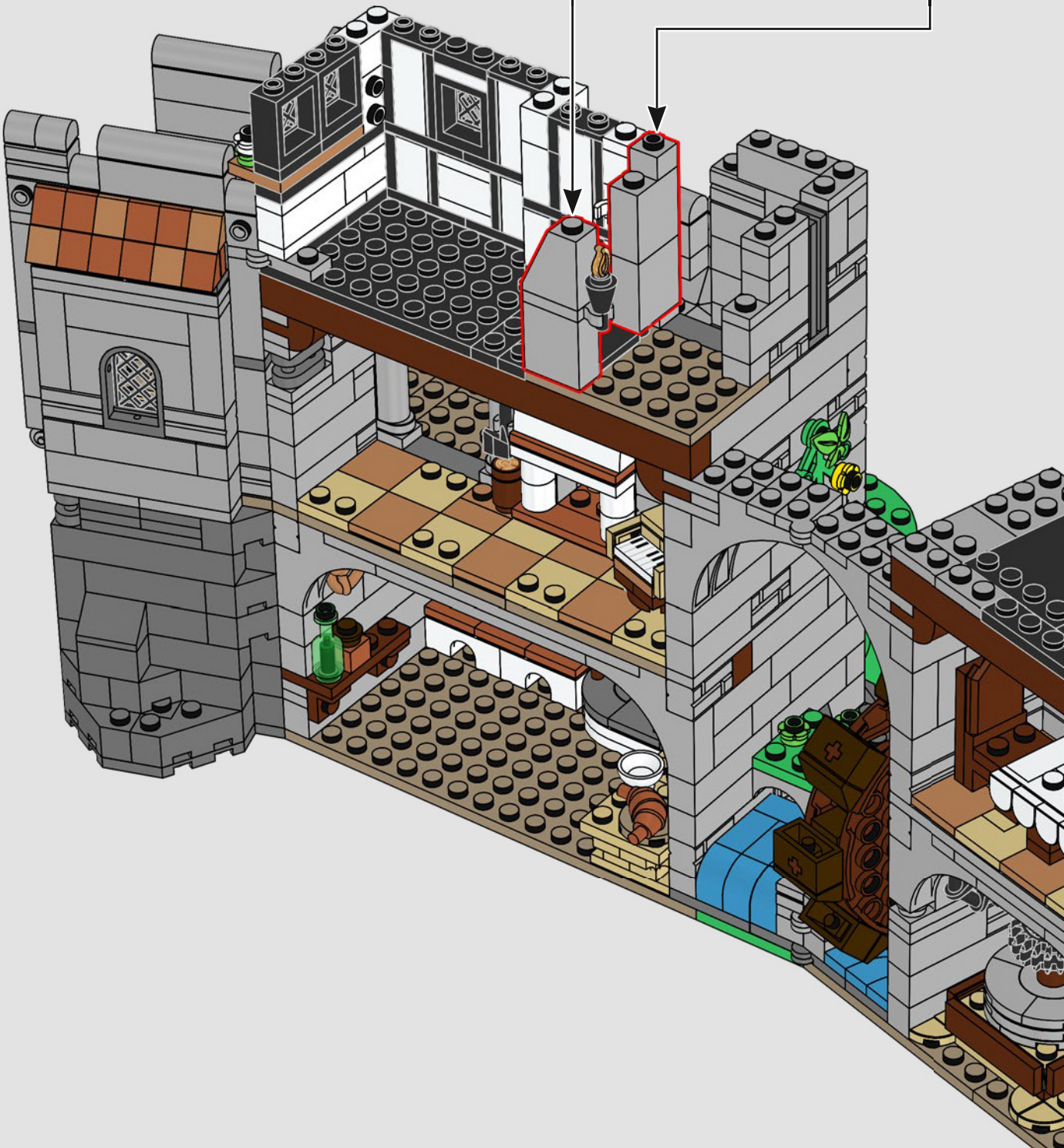
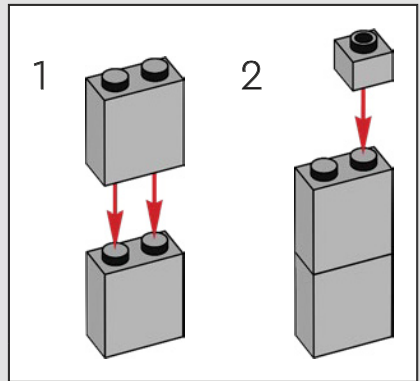
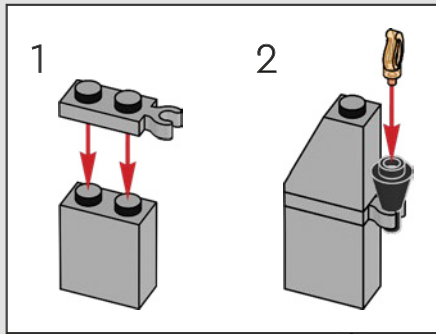

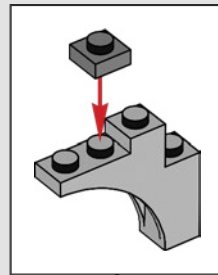
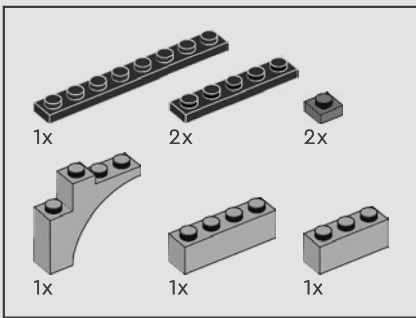

189

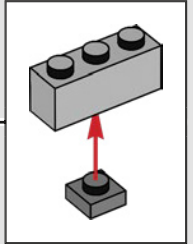
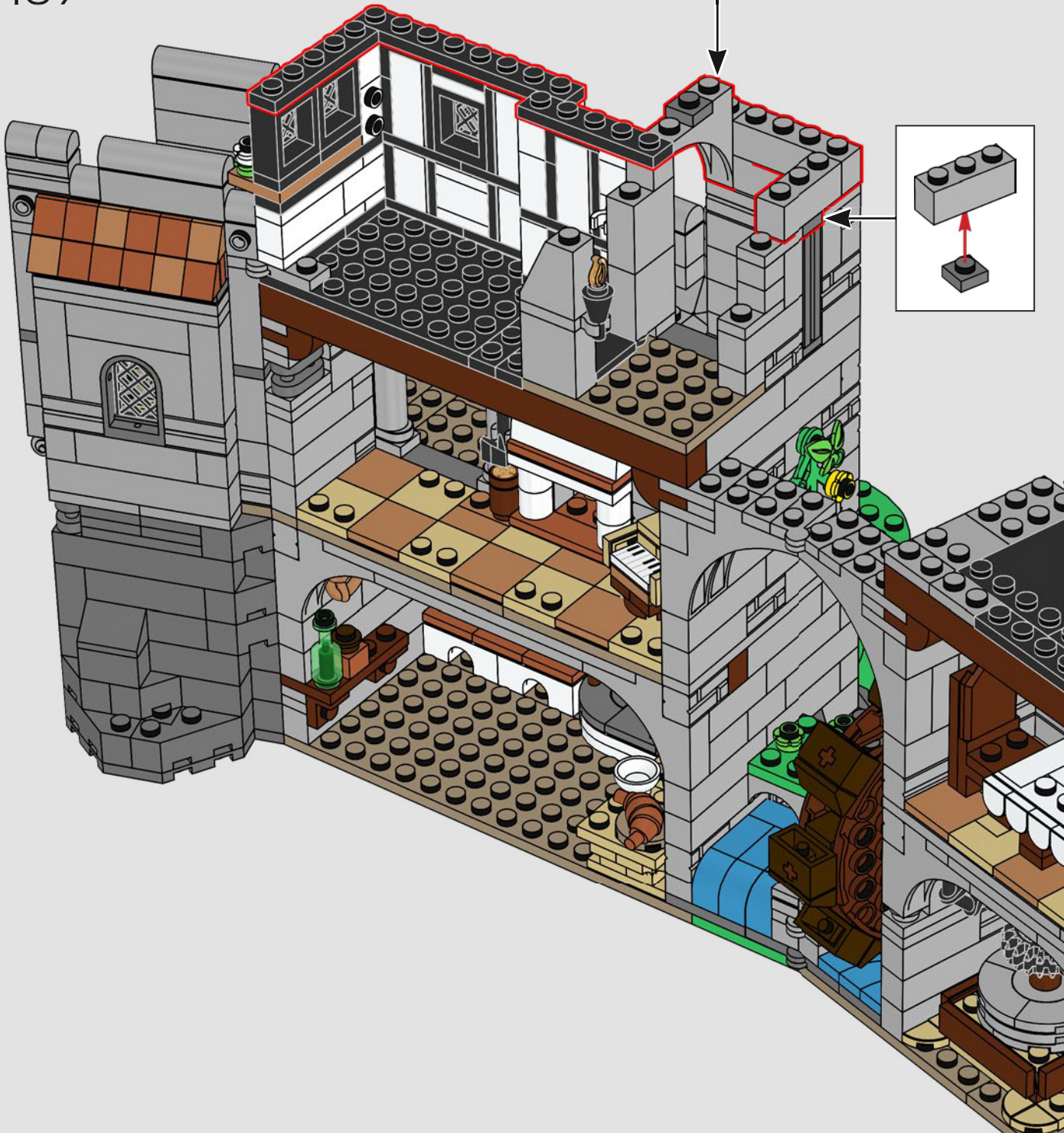

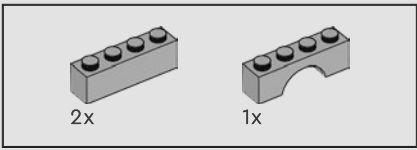

190





Quel magnifique bibelot ! Il rappelle un château d'il y a plusieurs générations...



191

1

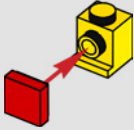

2

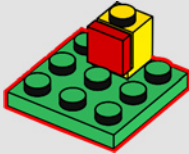

3

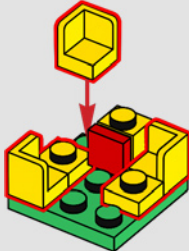

4

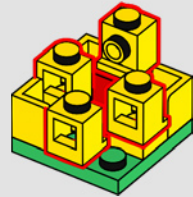

5

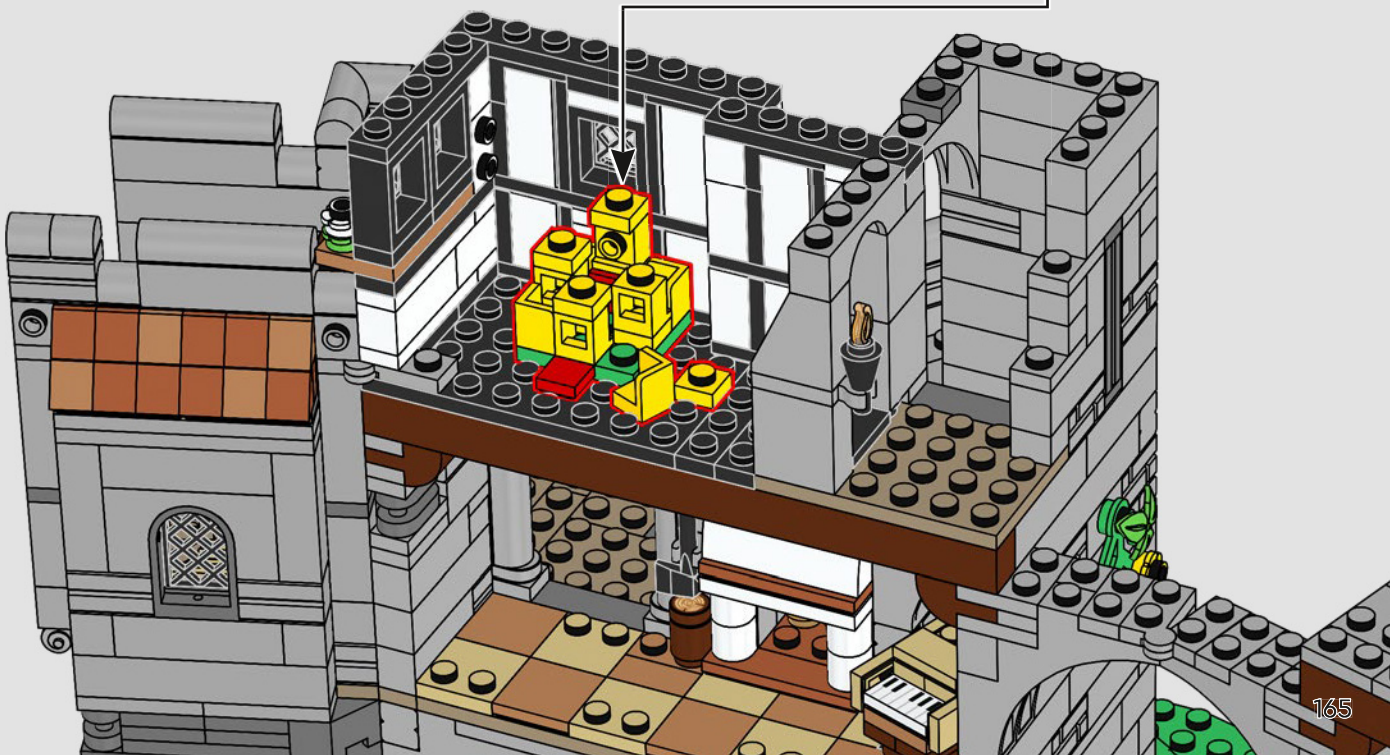
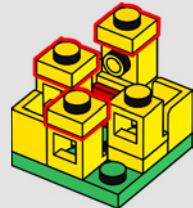

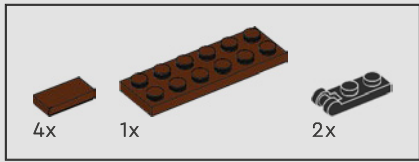

192

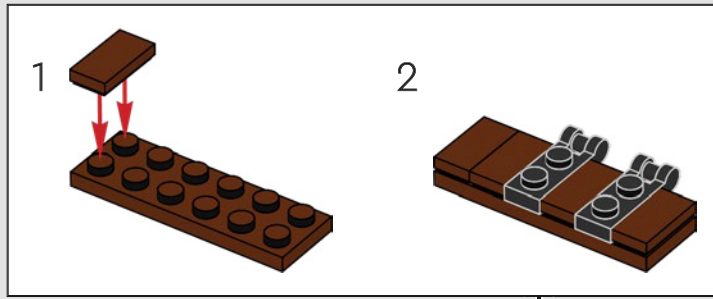

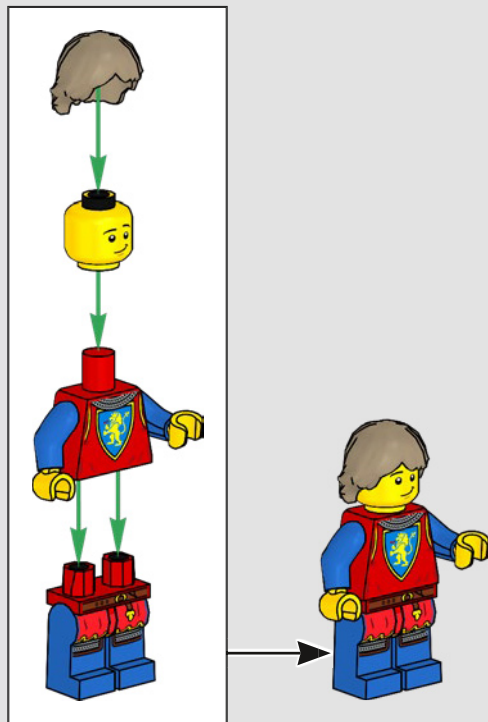

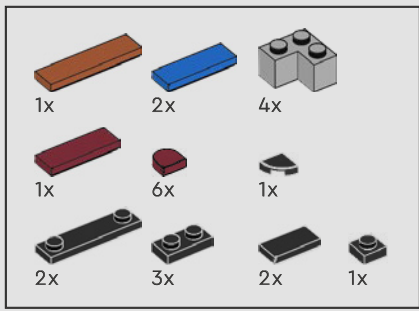

193

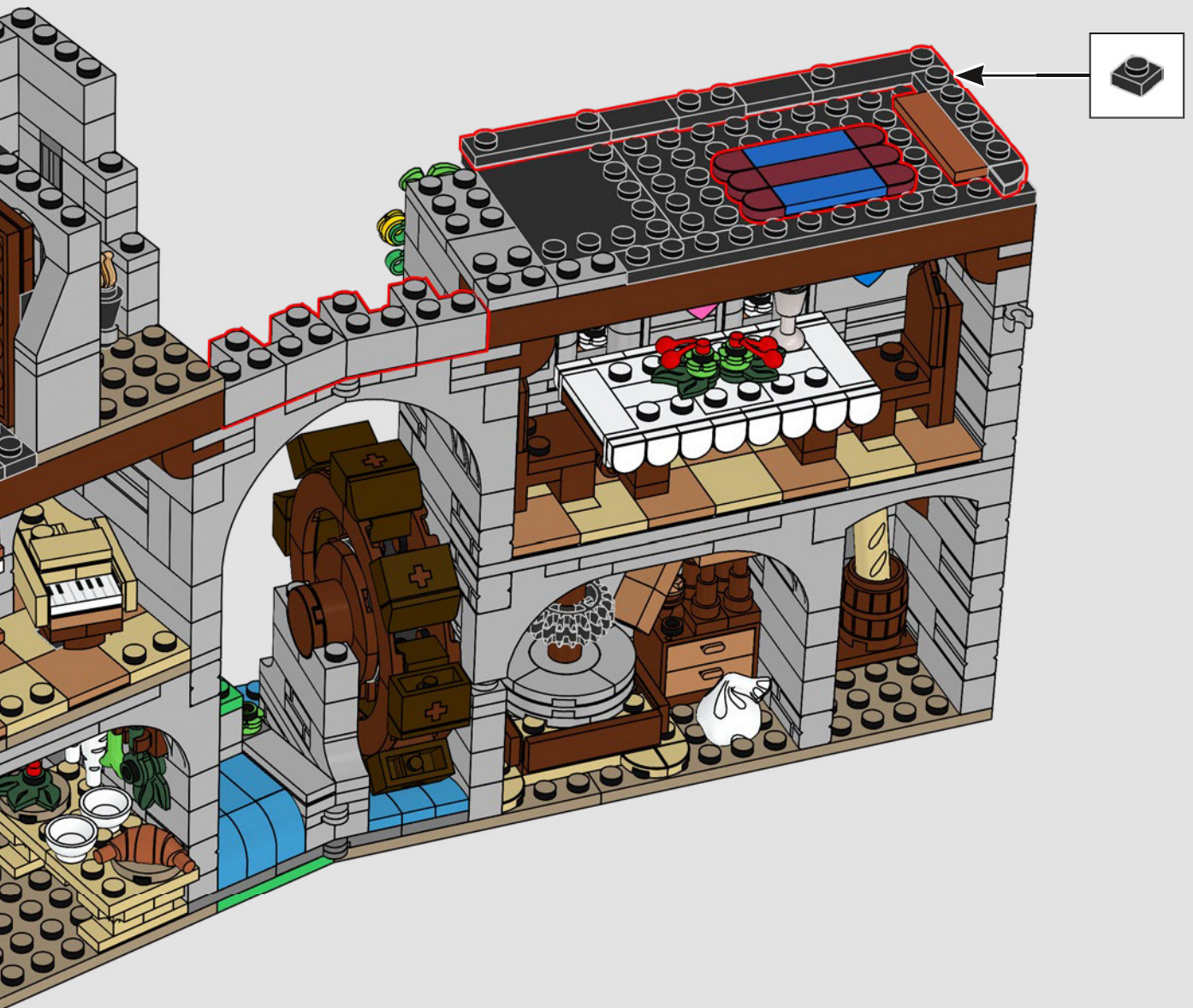

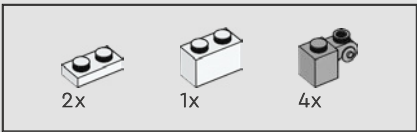

194

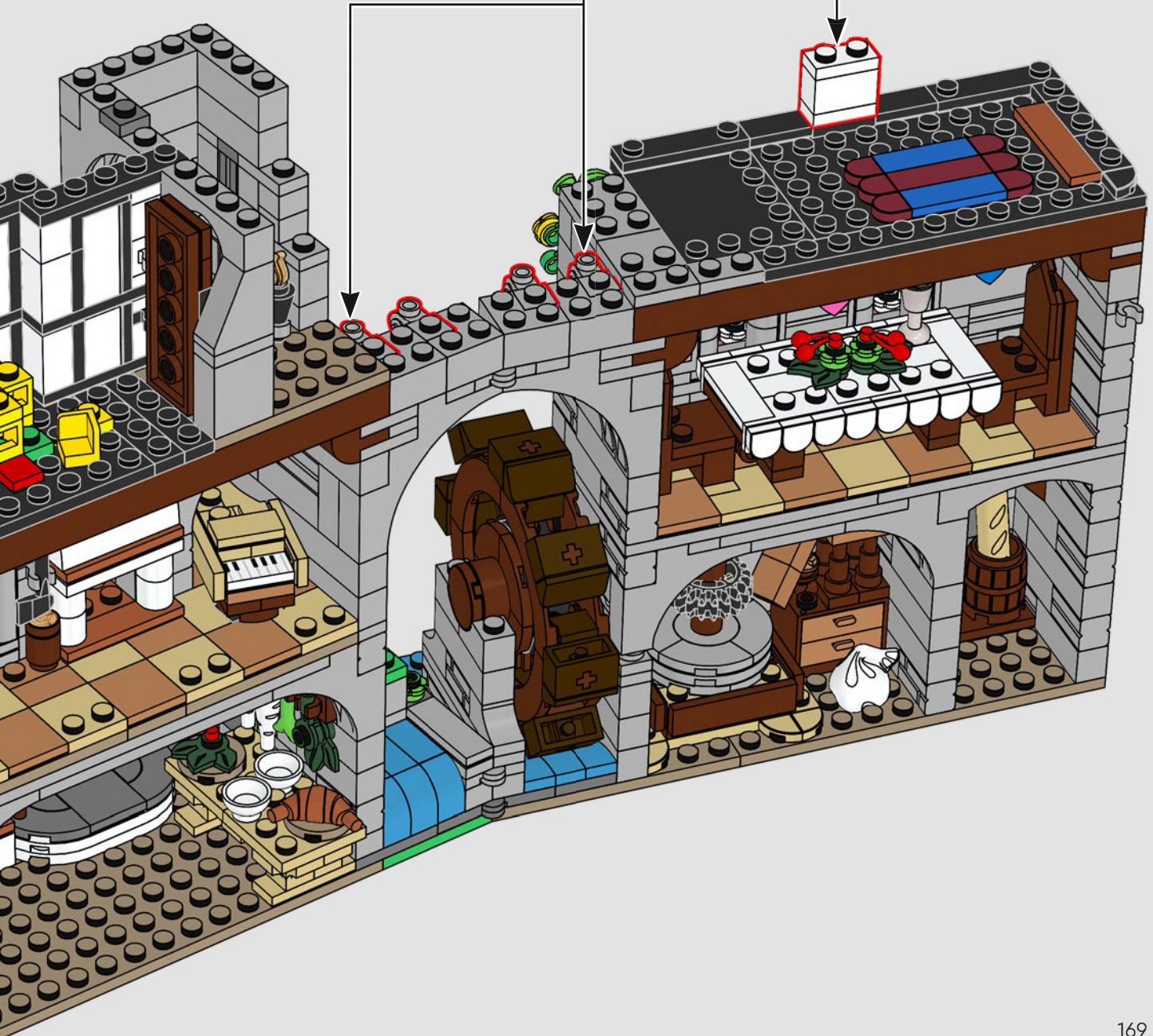
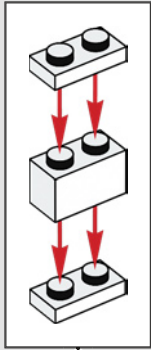
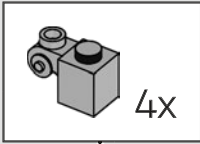

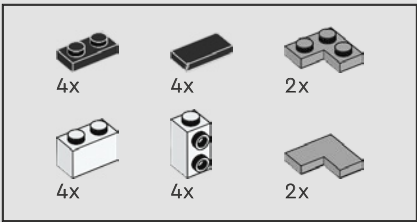

195

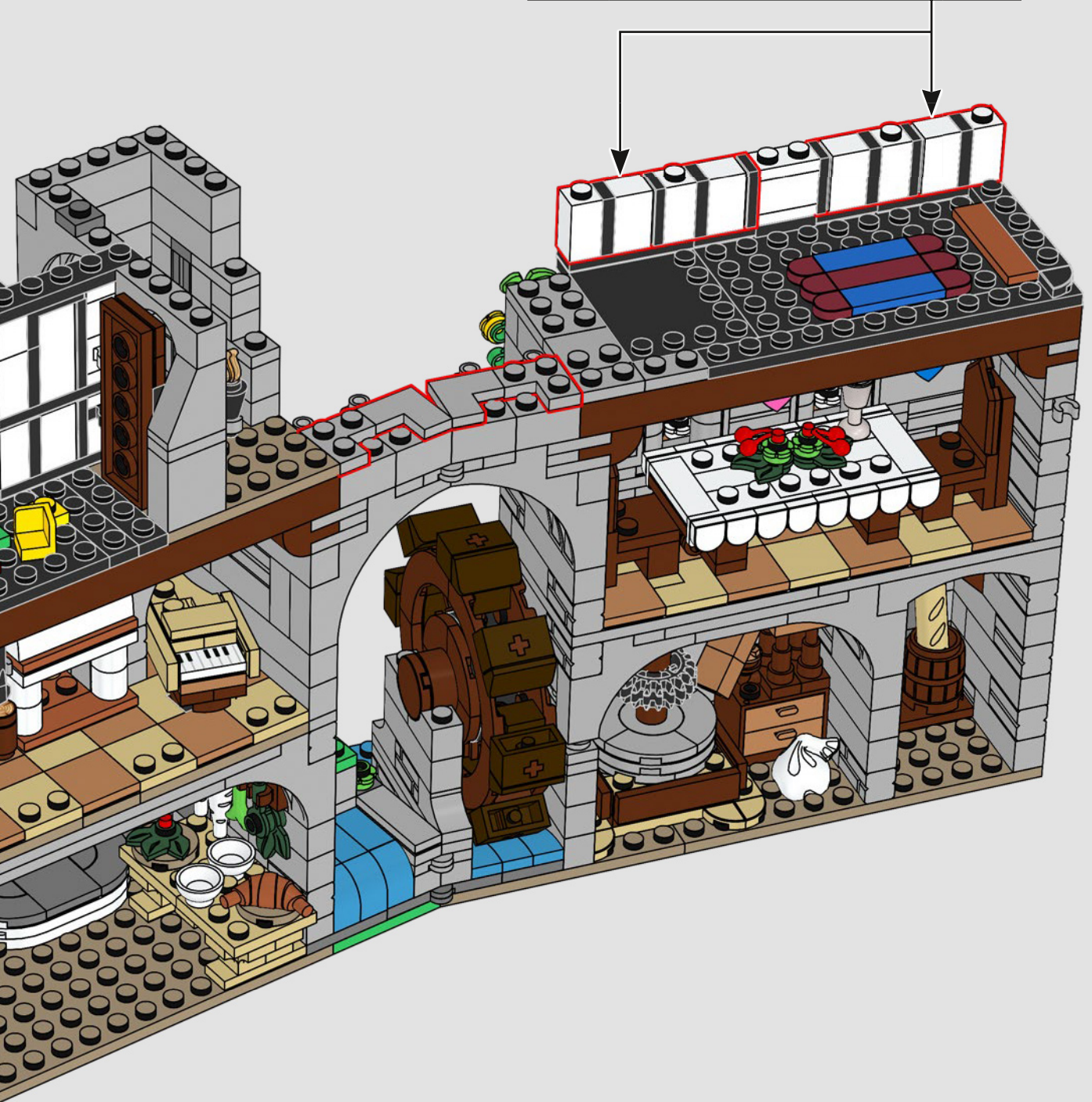
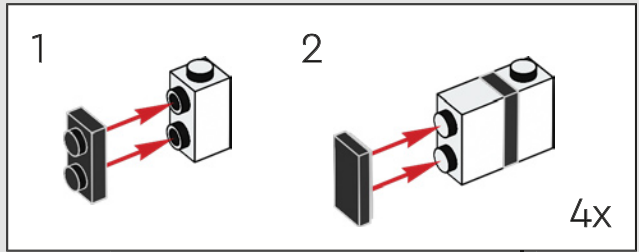

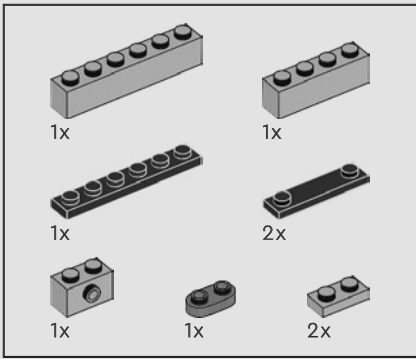

196

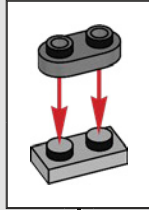

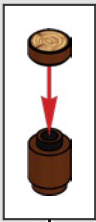
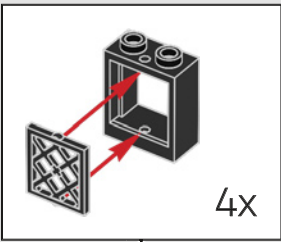
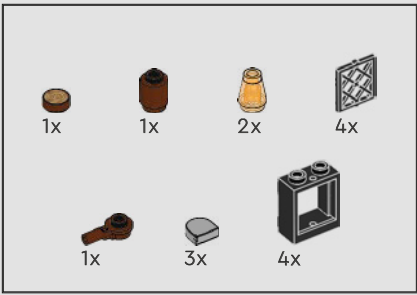

197

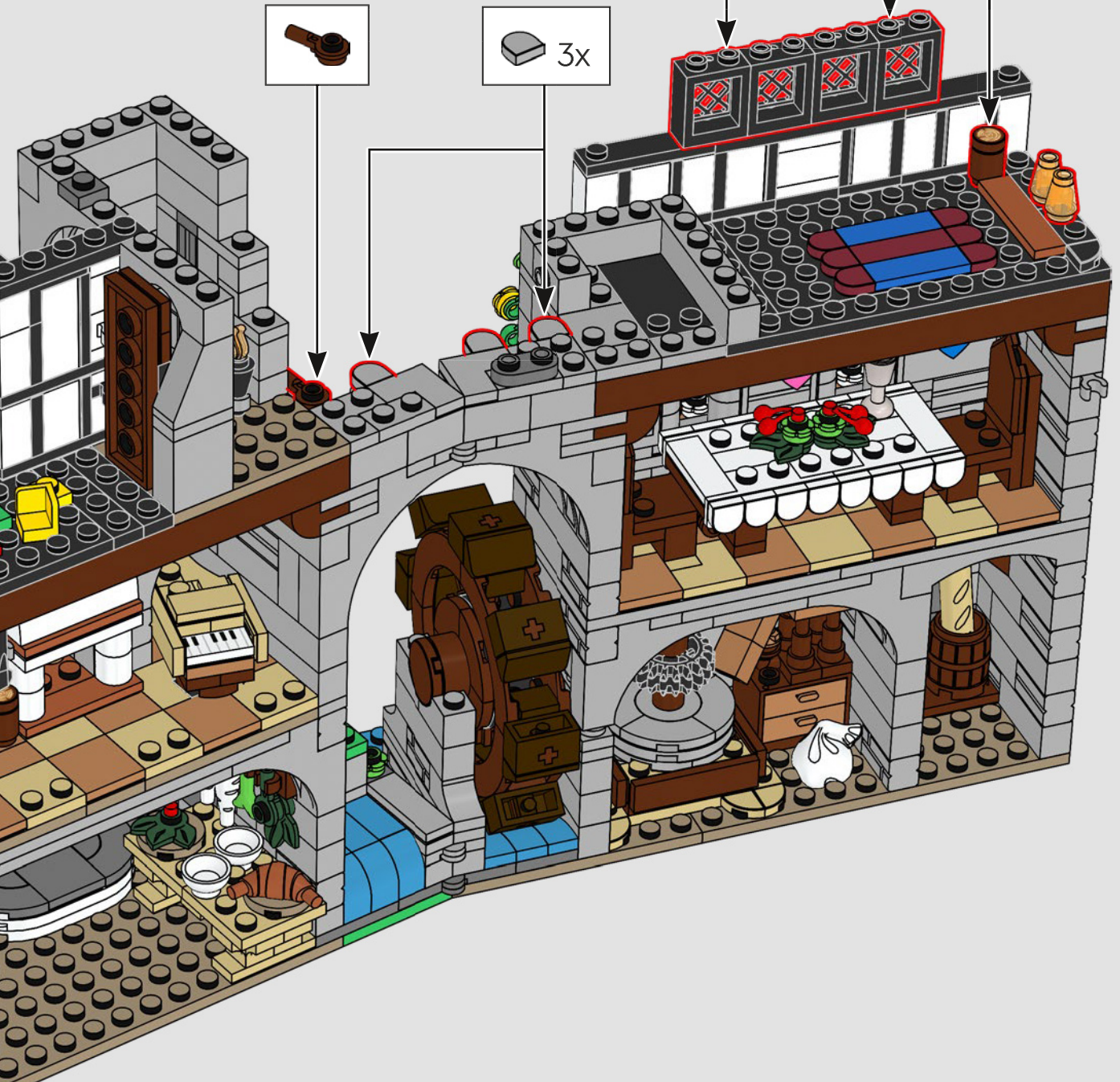

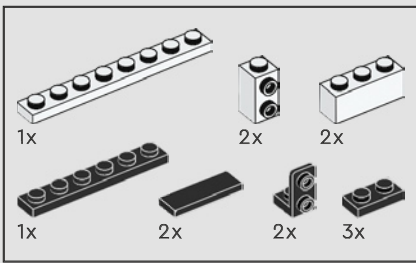

198

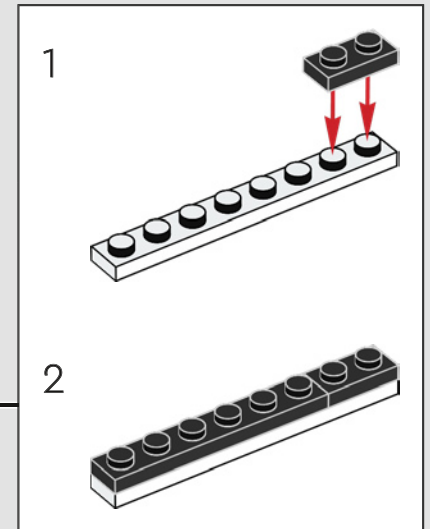
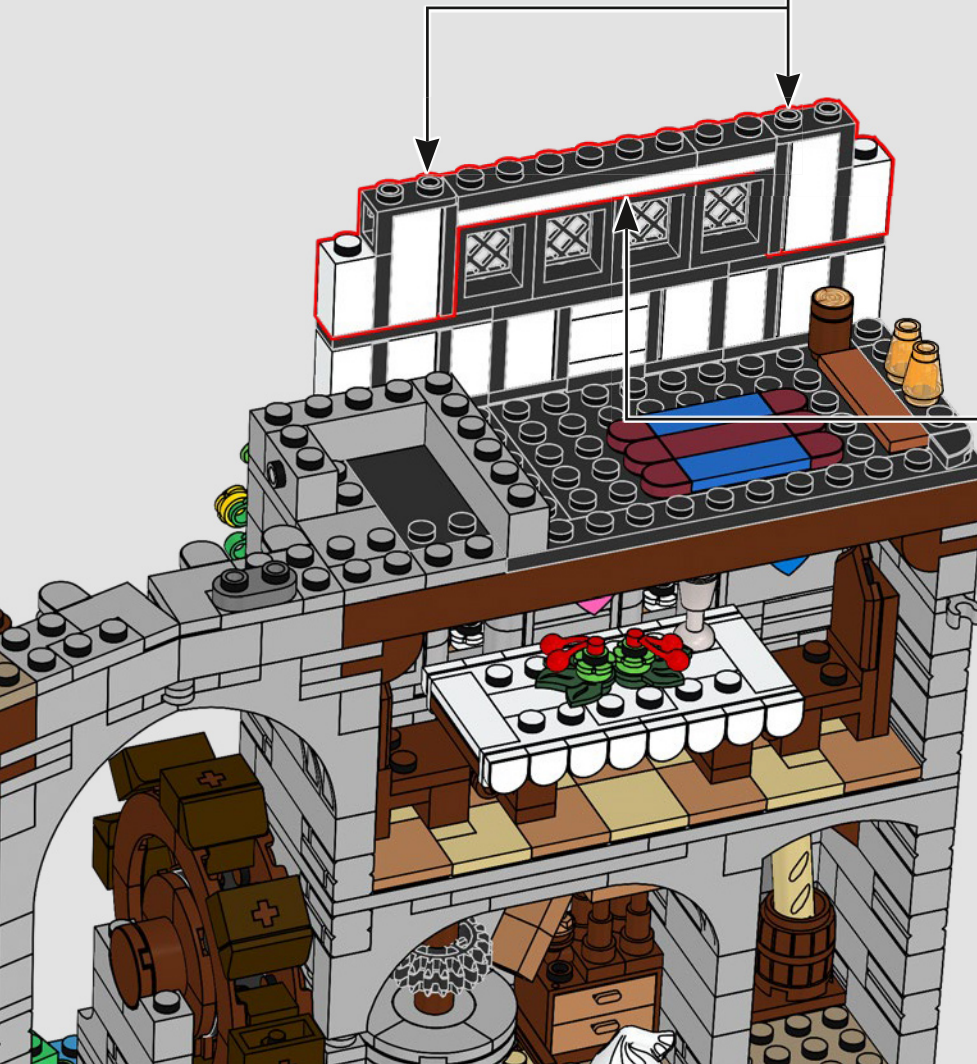
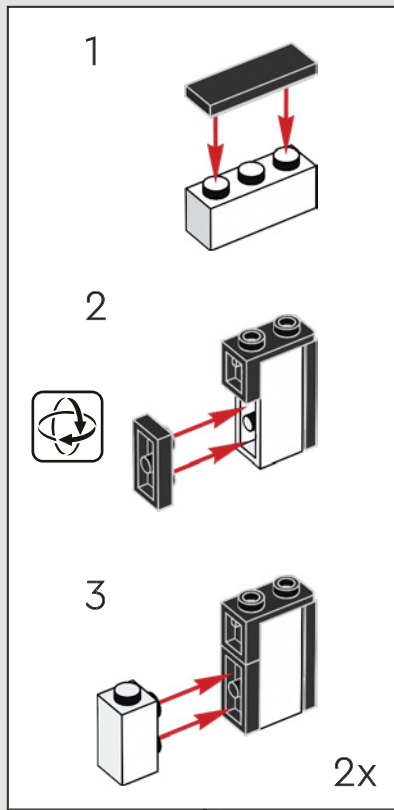

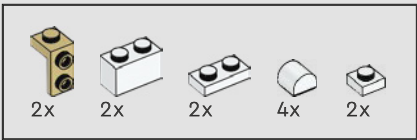

199

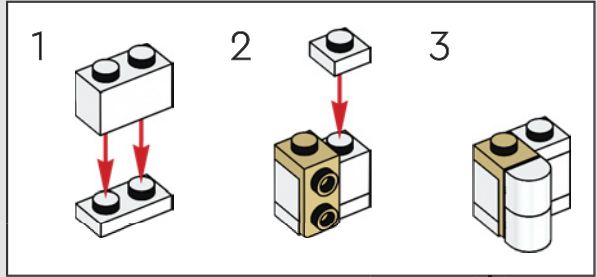
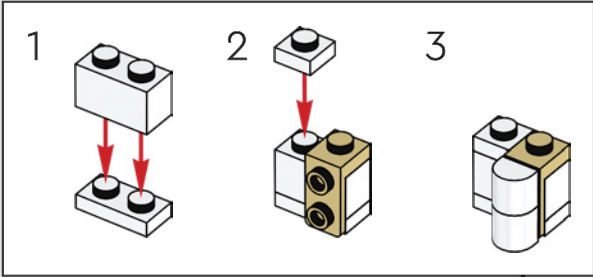

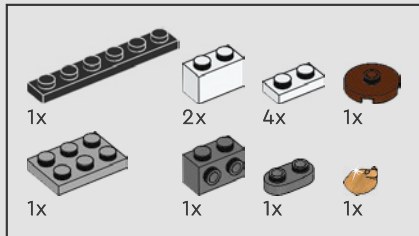

200

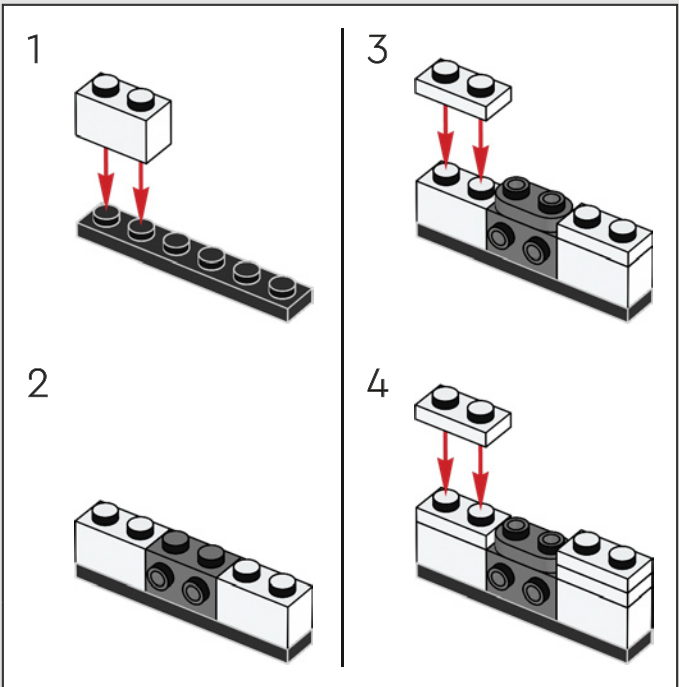
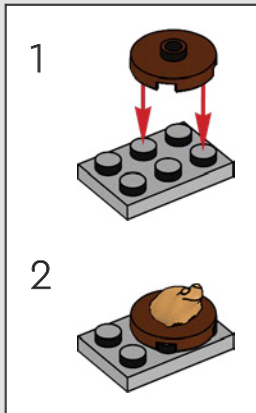

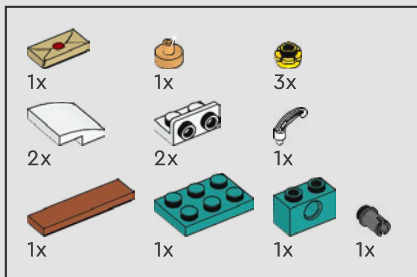

201



Qu'est-ce que cette étrange lettre sur la table, marquée du sceau de Lord Basil ? !

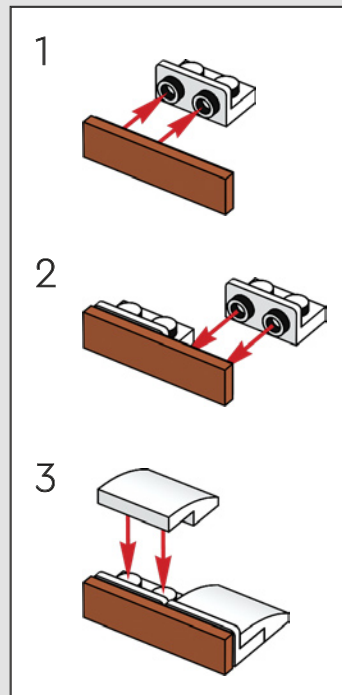
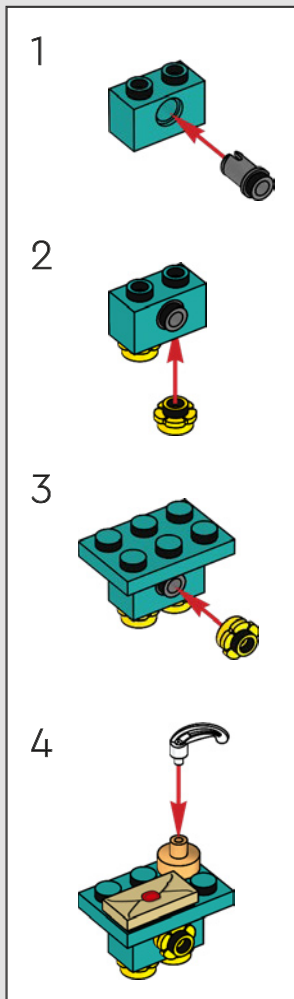

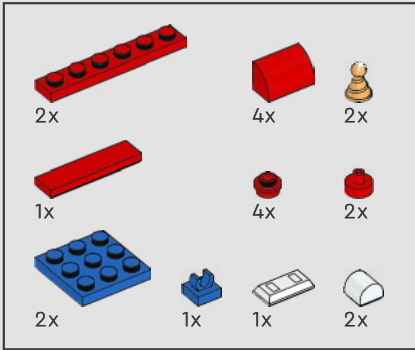
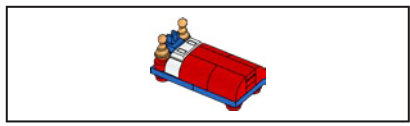

202

1

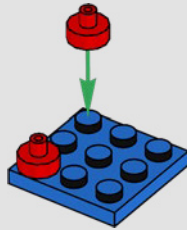

2

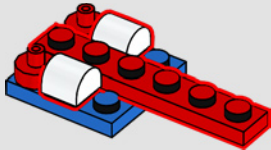

3

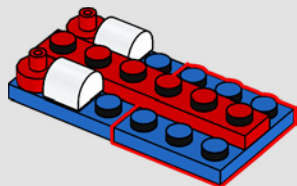

4

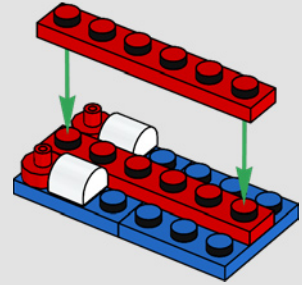

5

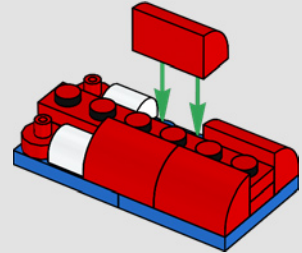

6

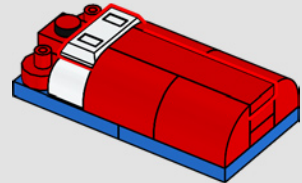

7

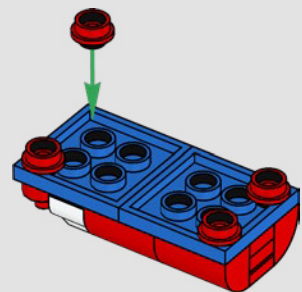

8

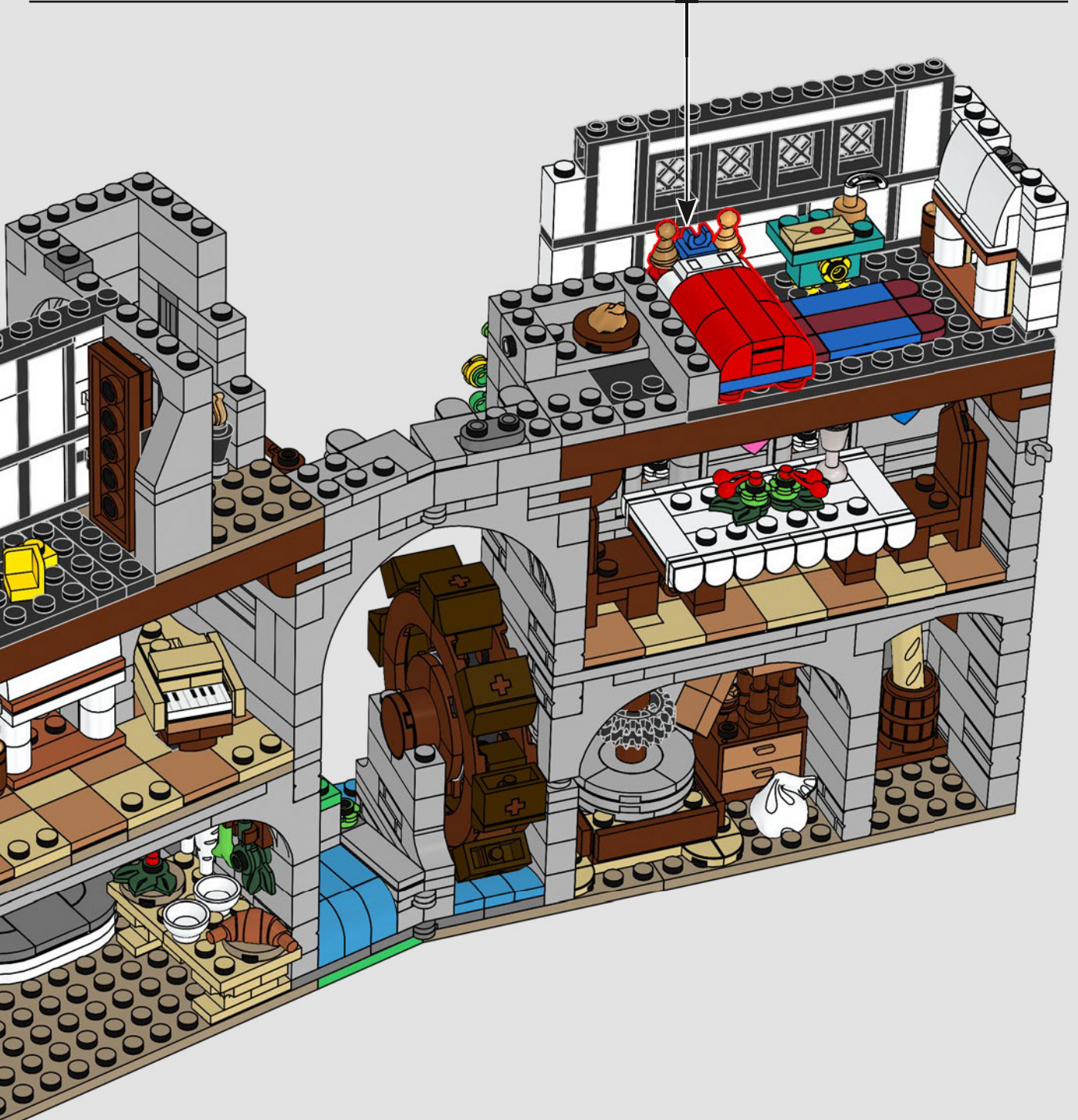
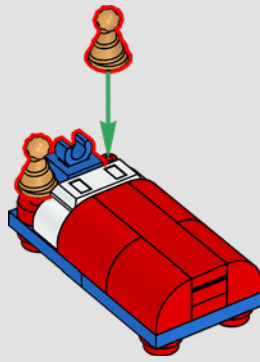

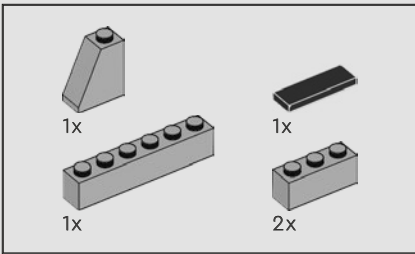

203

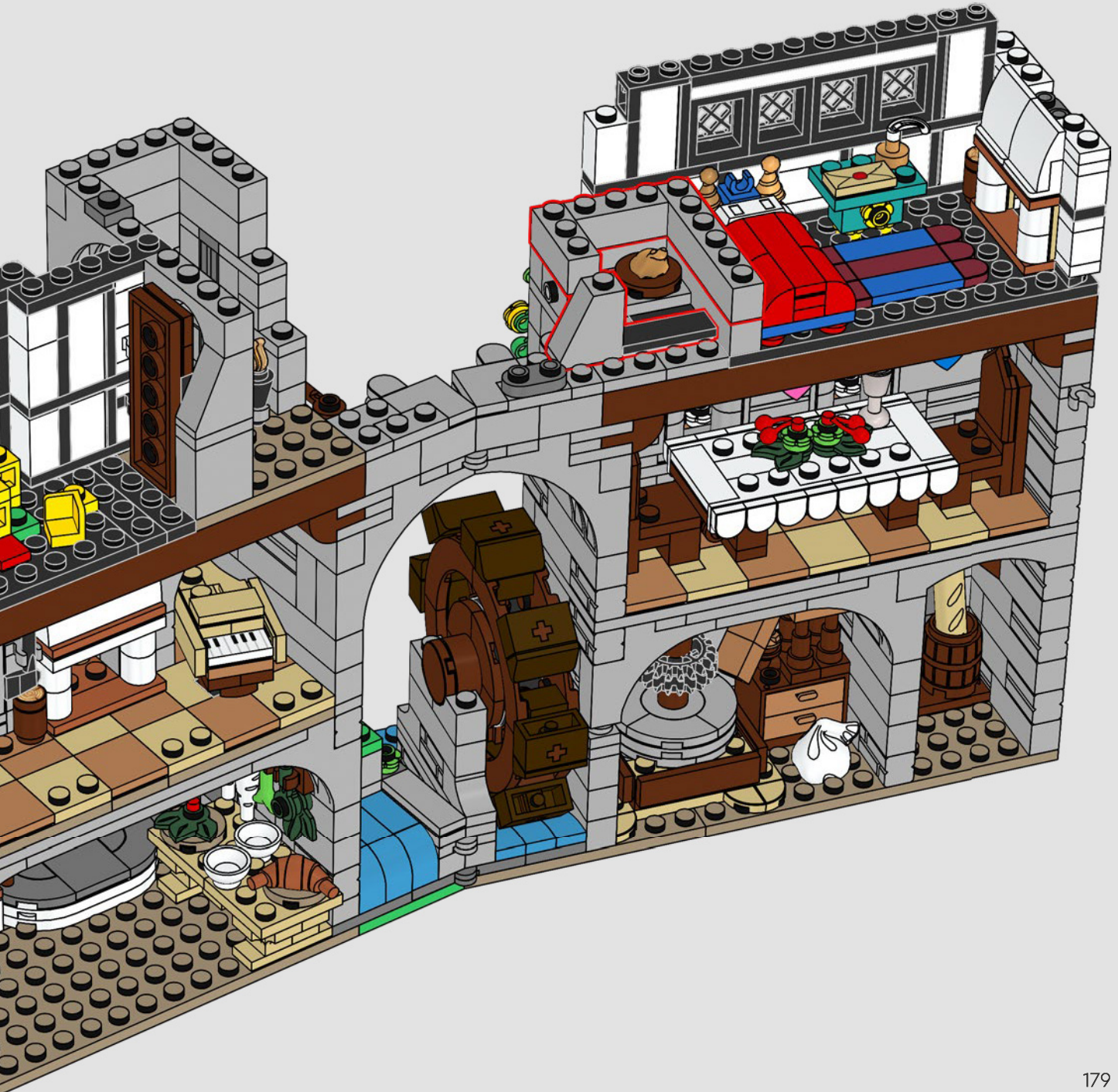

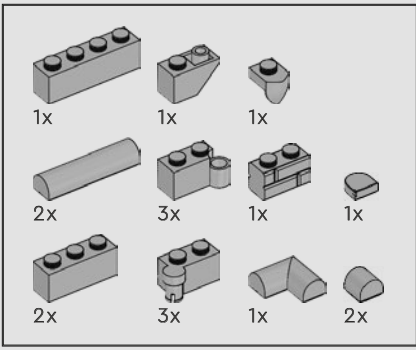

204

1

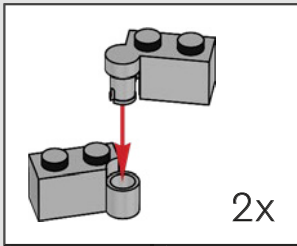
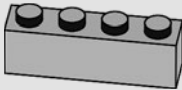

2

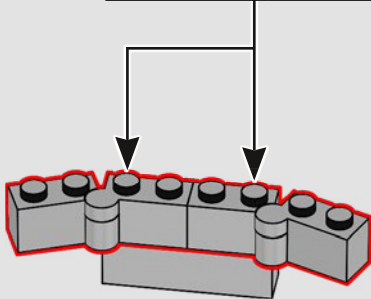

3

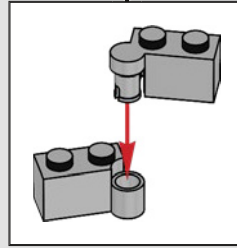
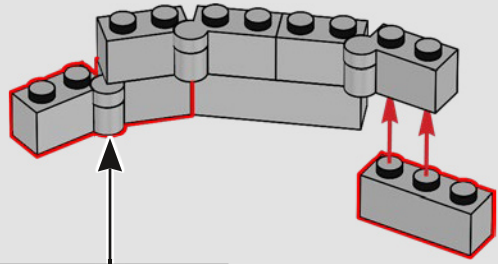

4

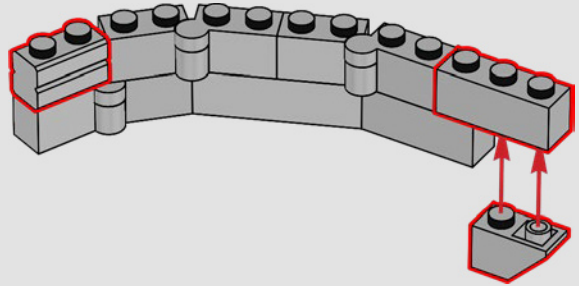

5

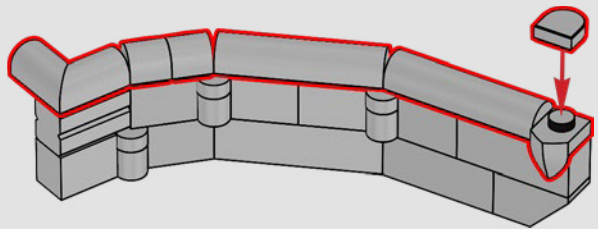

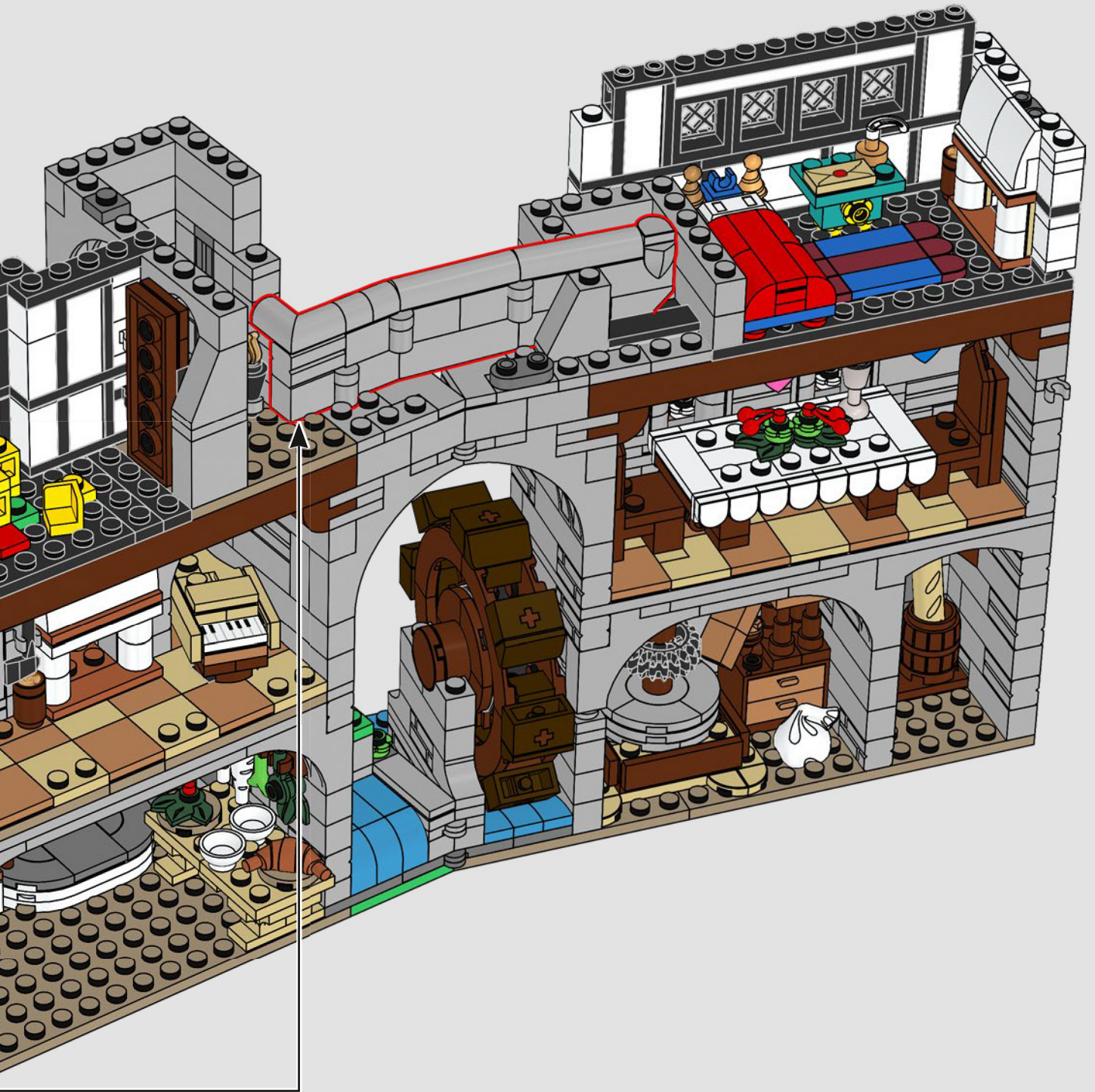



Ce mur est magique ! Une analyse plus approfondie sera nécessaire pour élucider ce mystère.

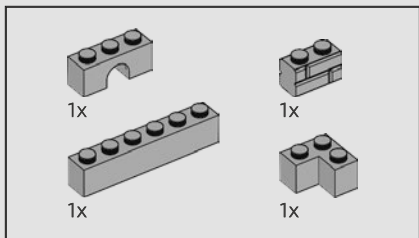

205

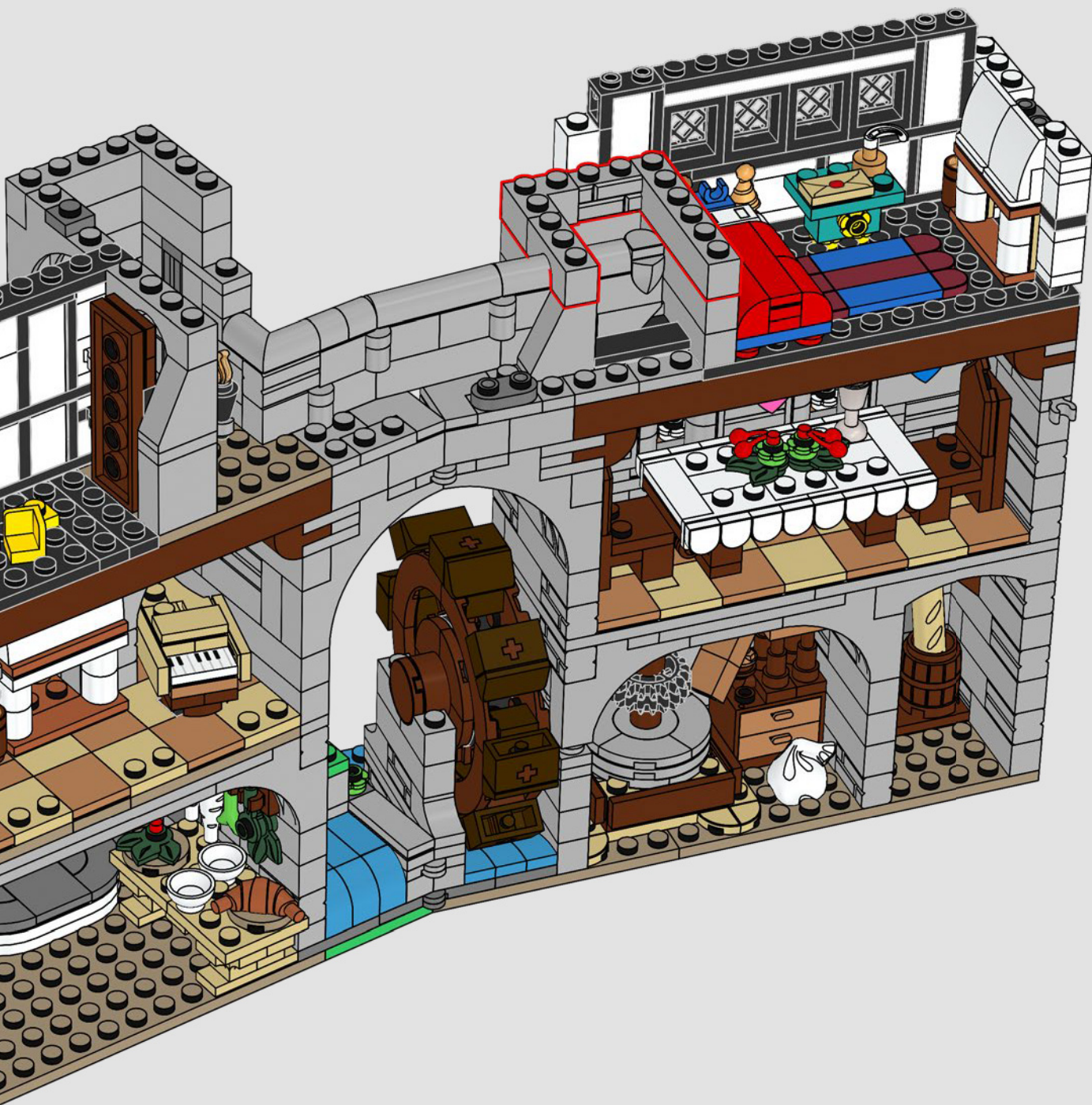

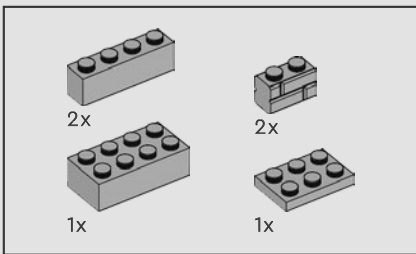

206

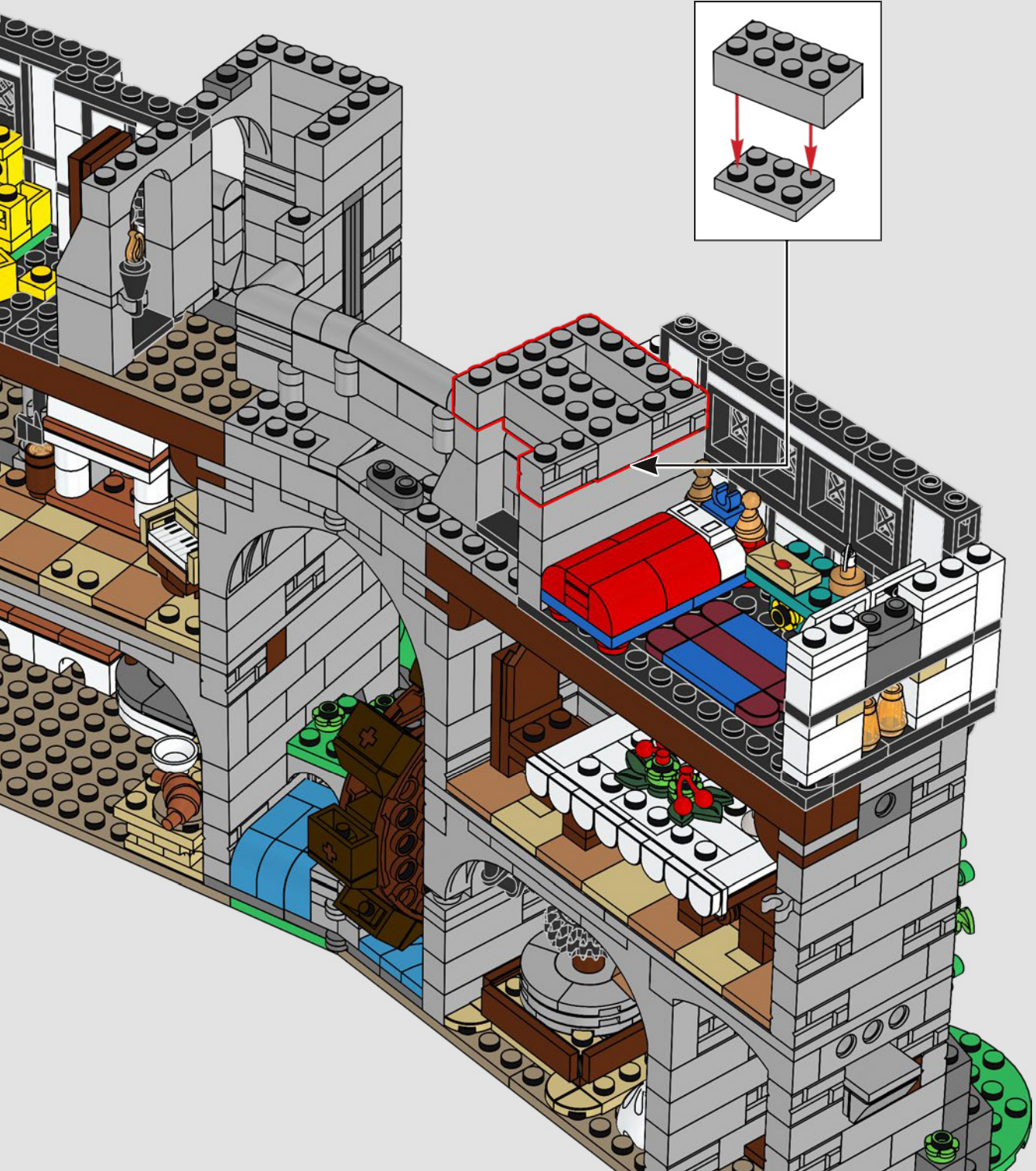

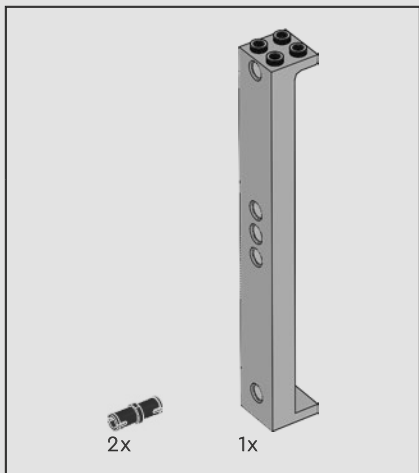

207

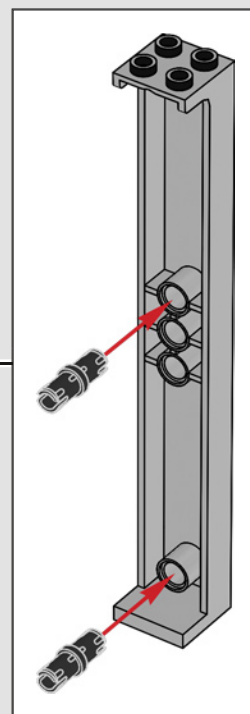
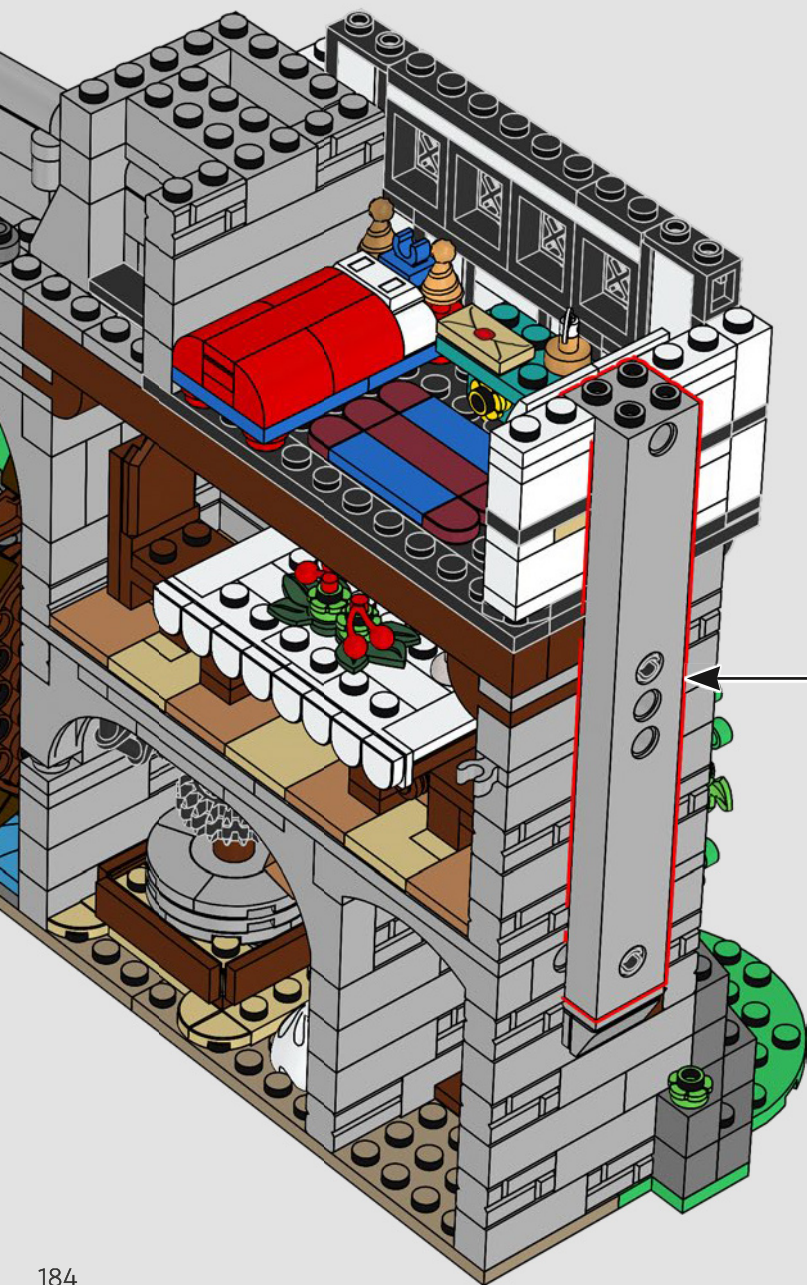

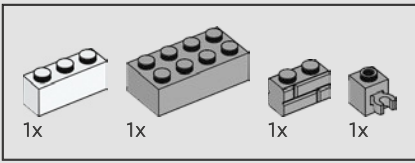

208



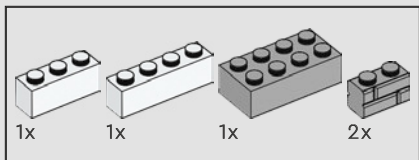

209



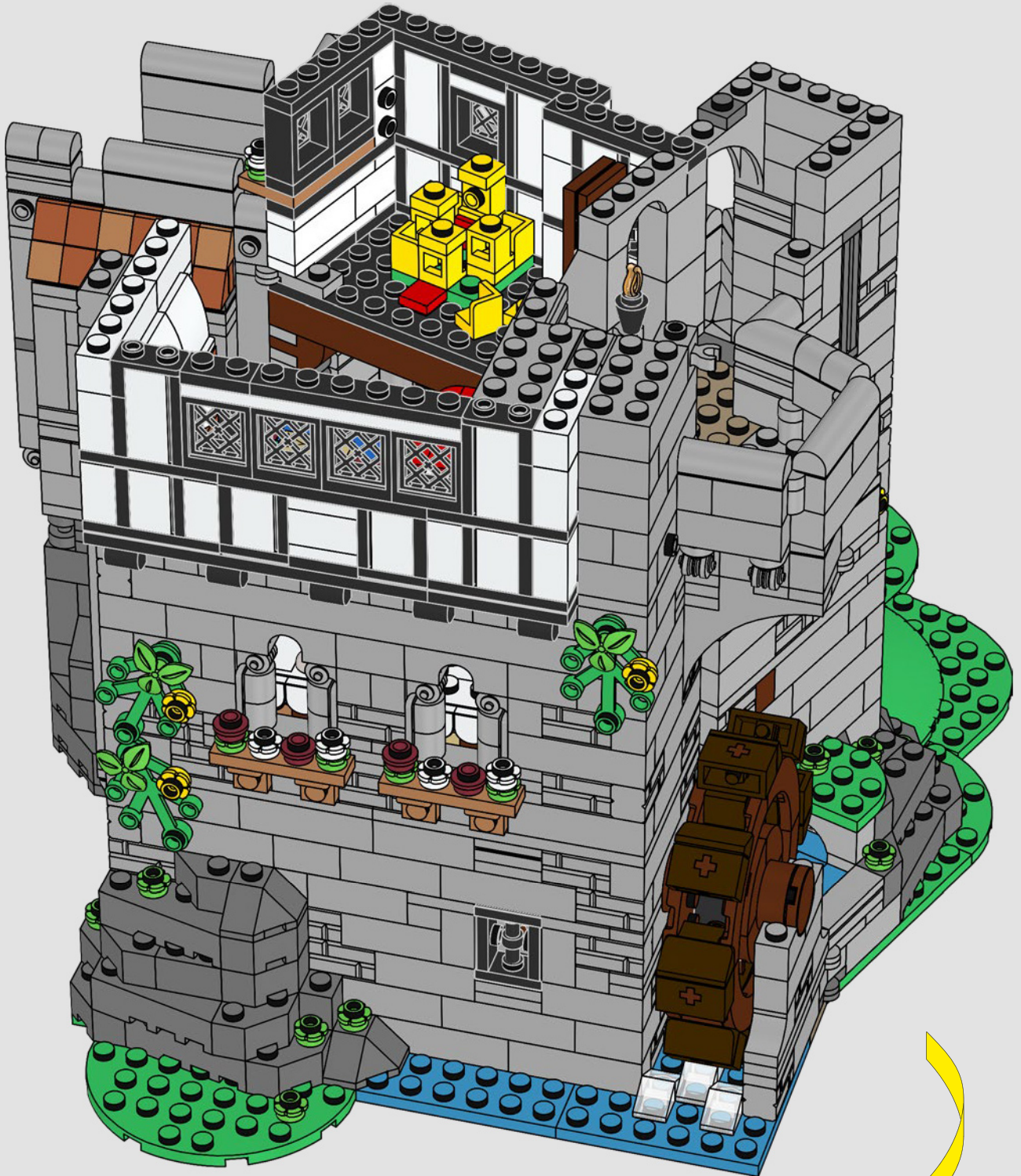

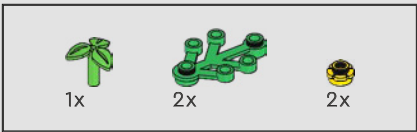

211

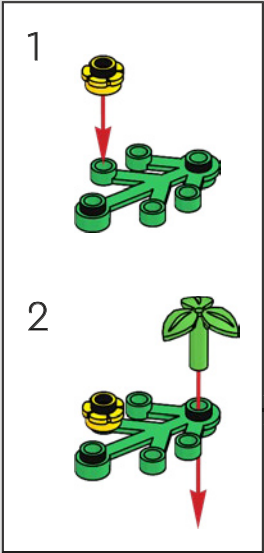
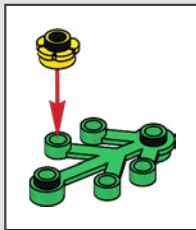

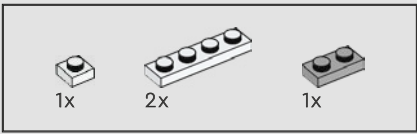

214

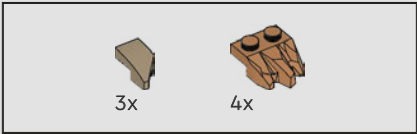
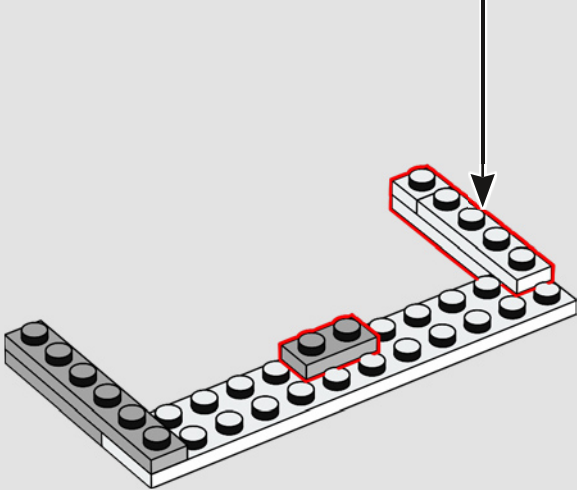
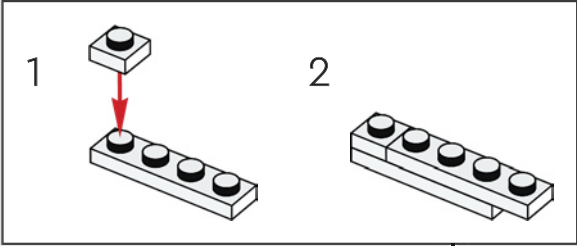

215

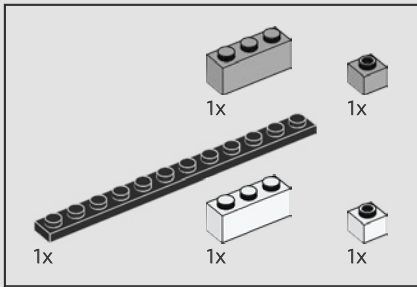
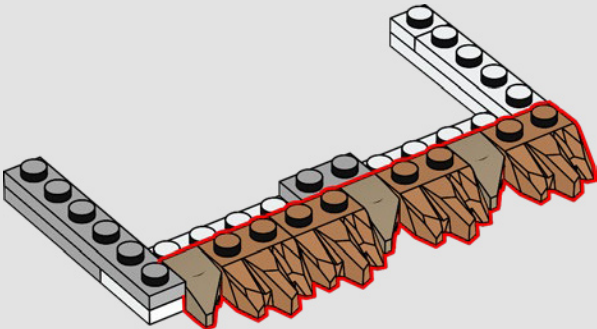

216

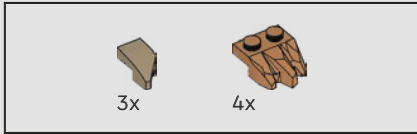
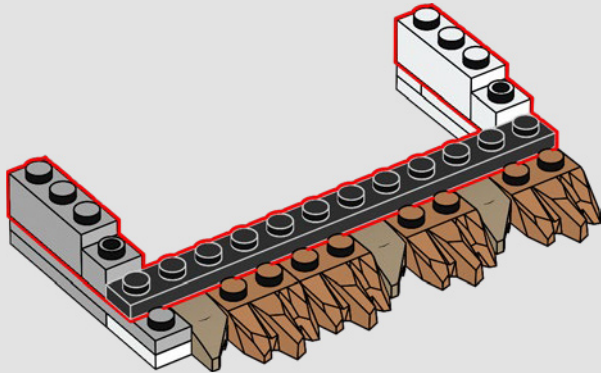

217

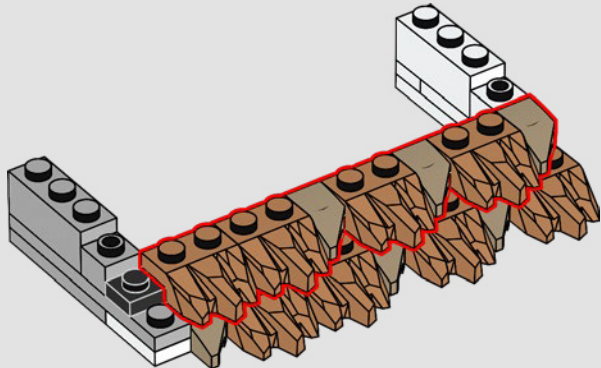

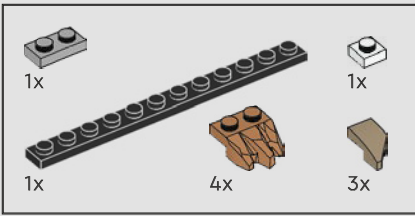

218

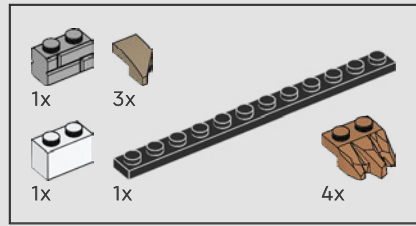
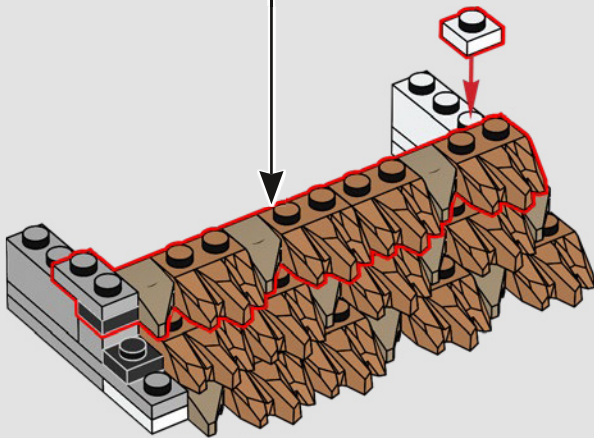
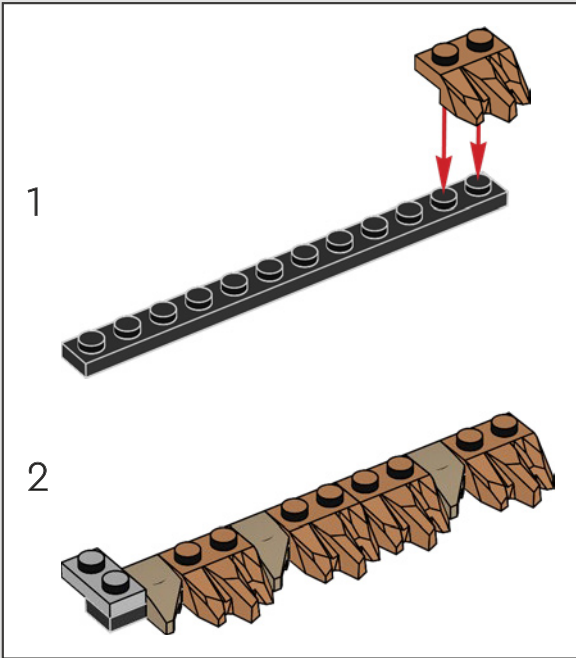

219

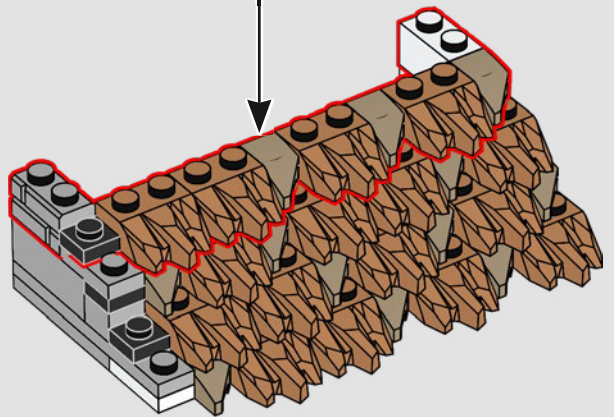
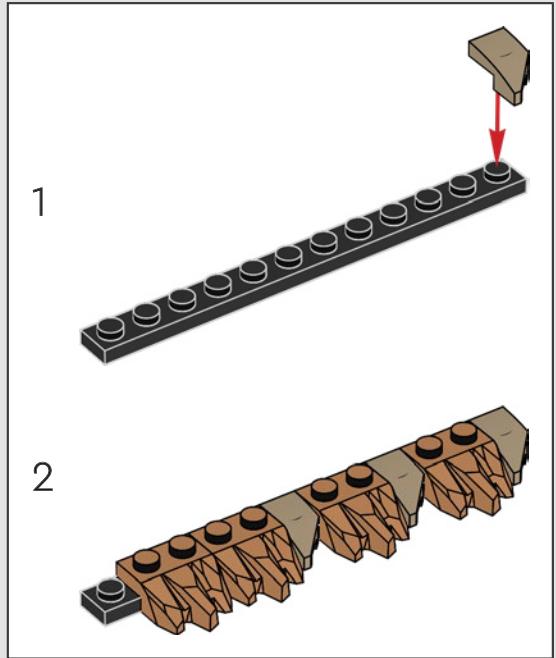

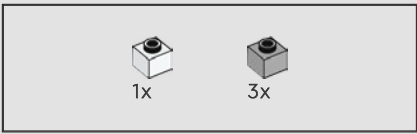

220

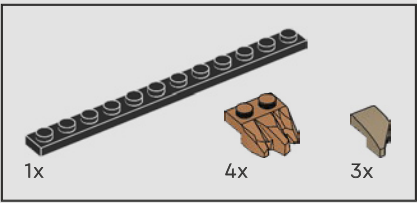
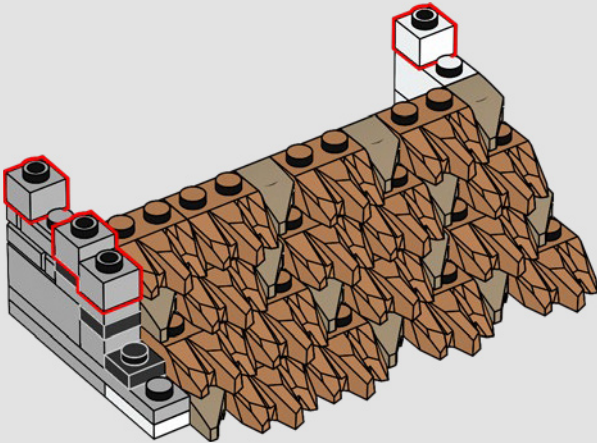

221

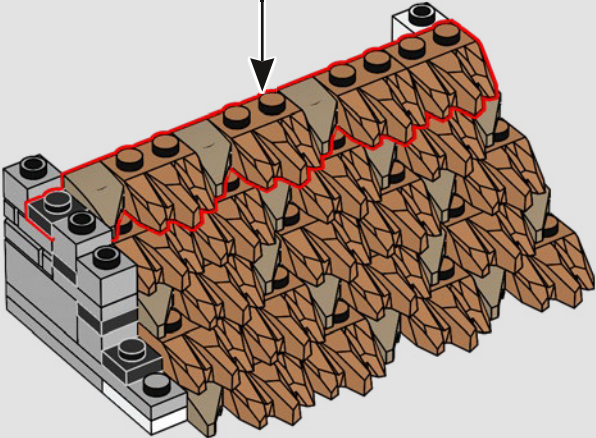
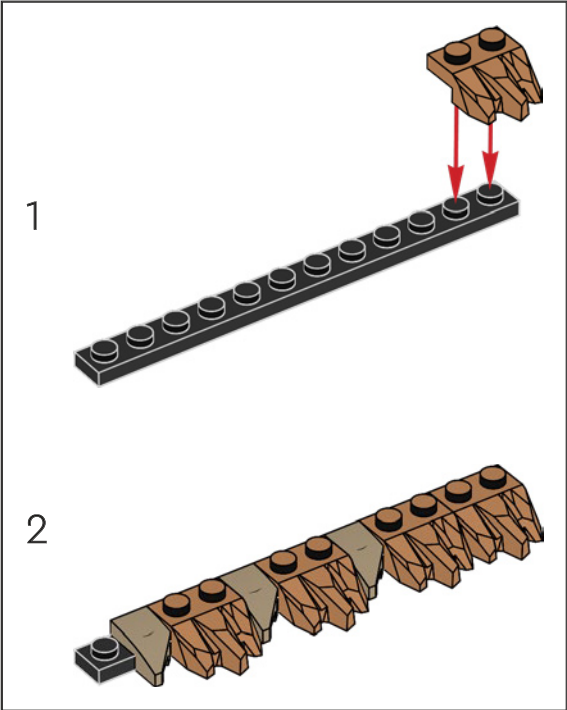

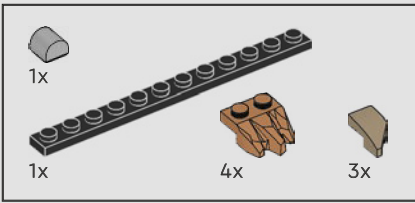

222

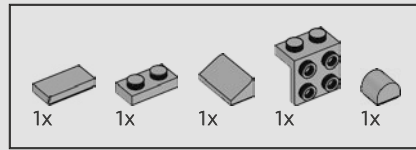
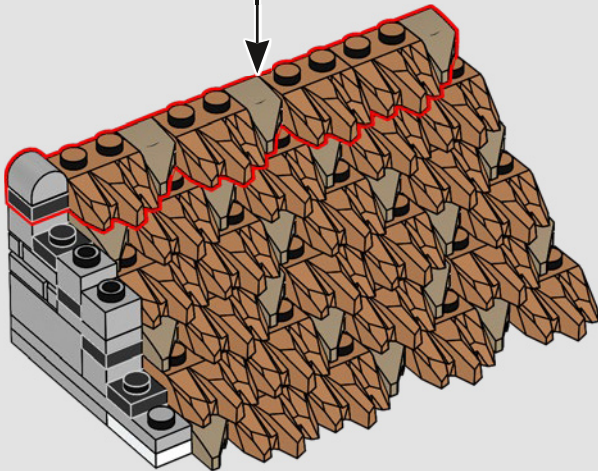
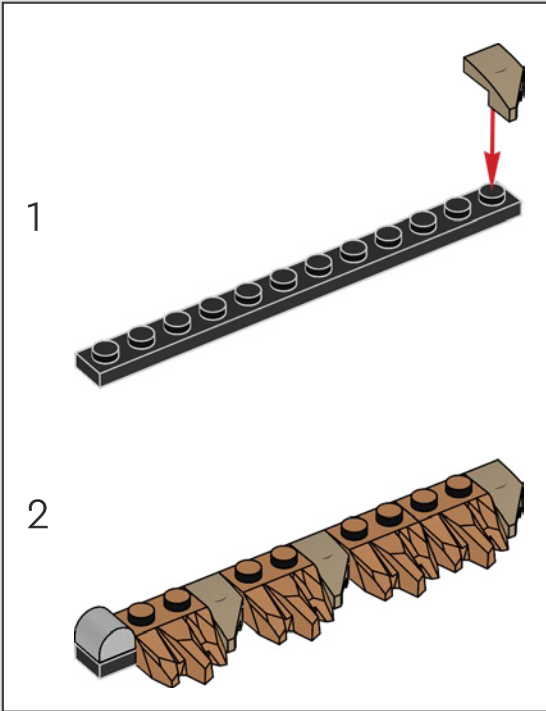

223

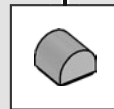
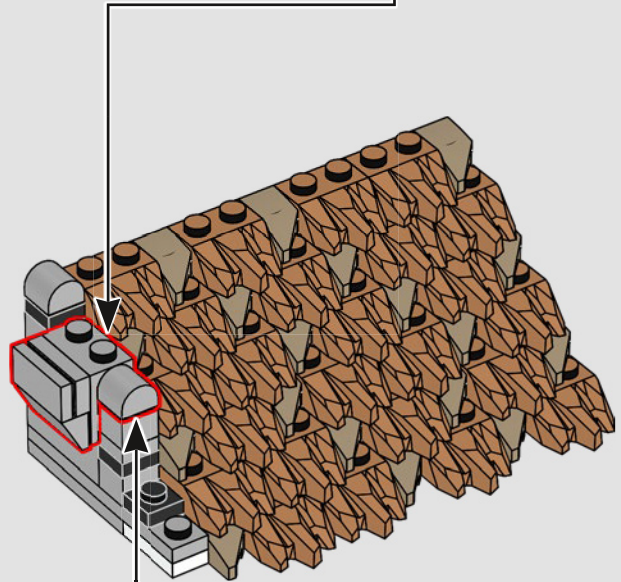
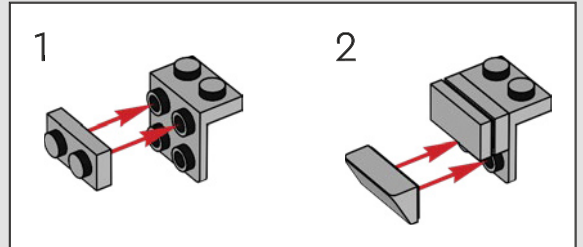



*Ce toit devrait garder les chambres
chaudes et sèches. La paille est un
matériau si ingénieux !*

224



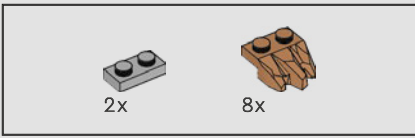

225

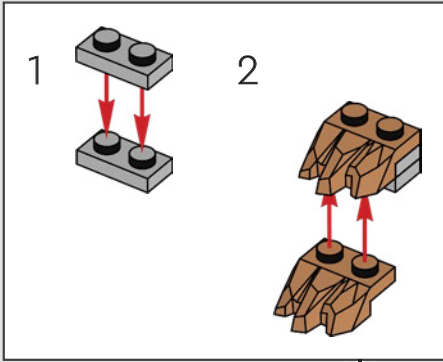

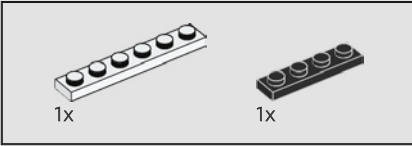
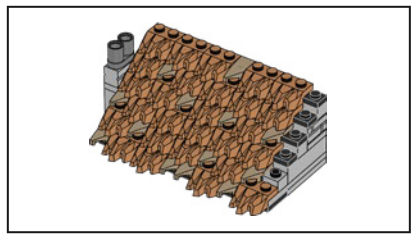

226

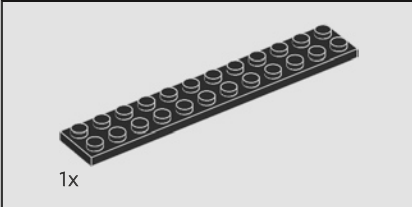
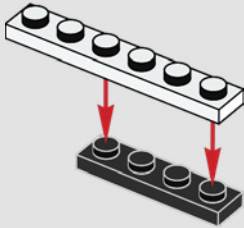

227

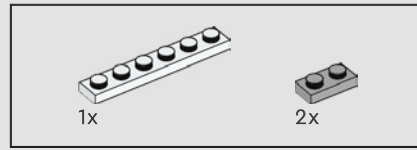
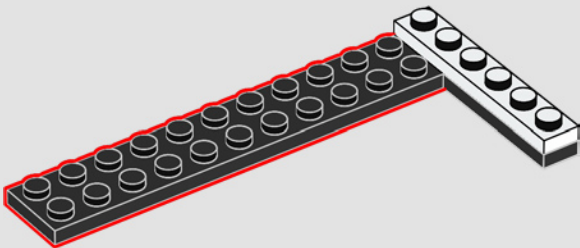

228

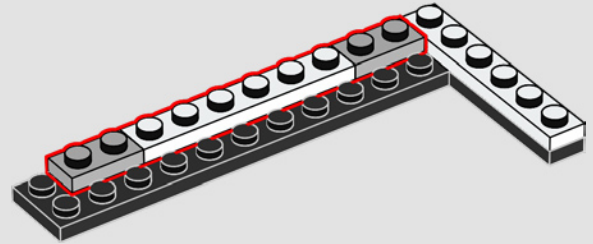

229

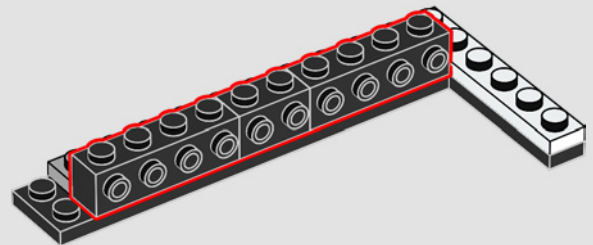

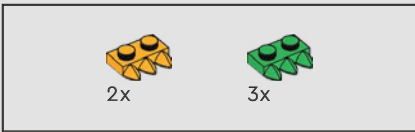

230

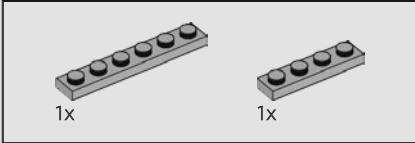
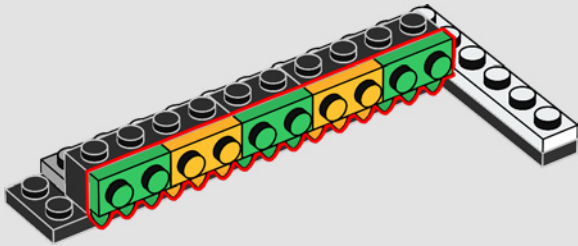

231

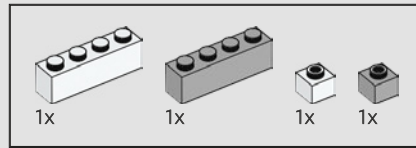
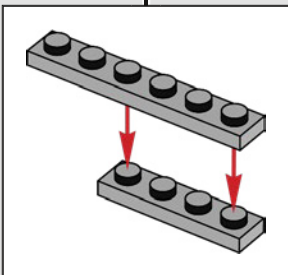
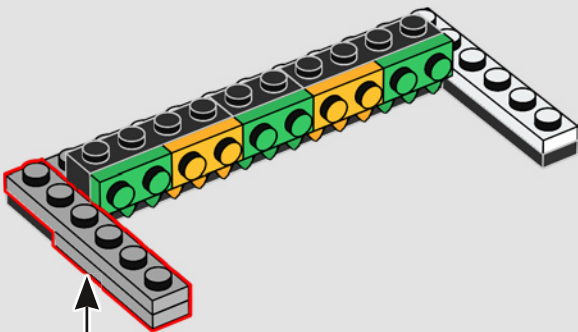

232

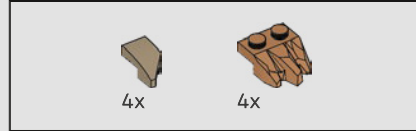
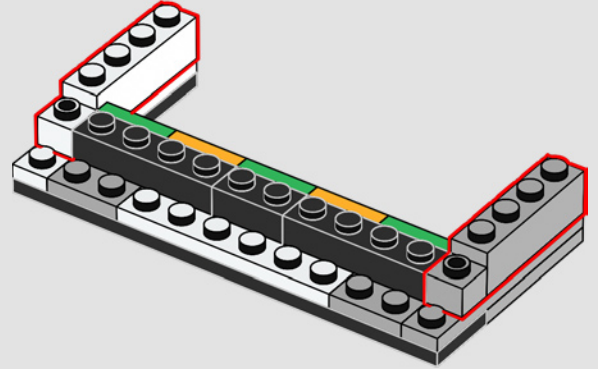

233

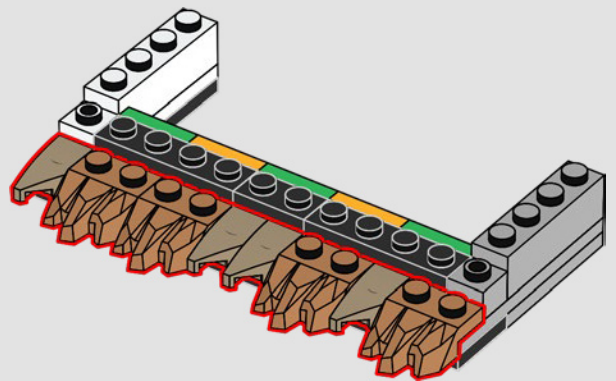

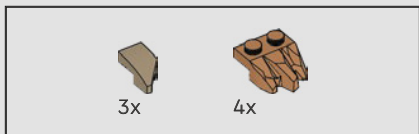

234

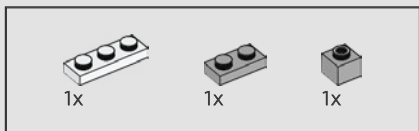
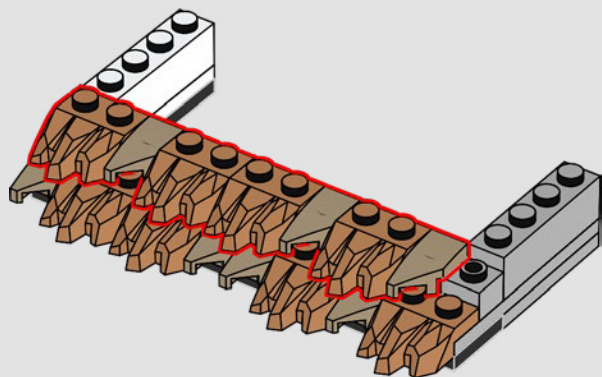

235

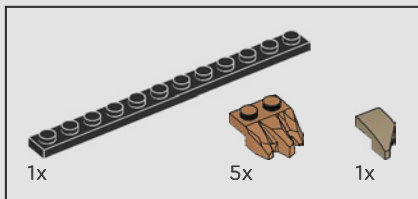
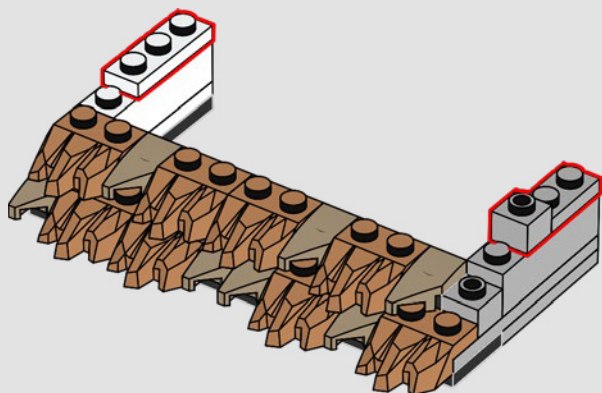

236

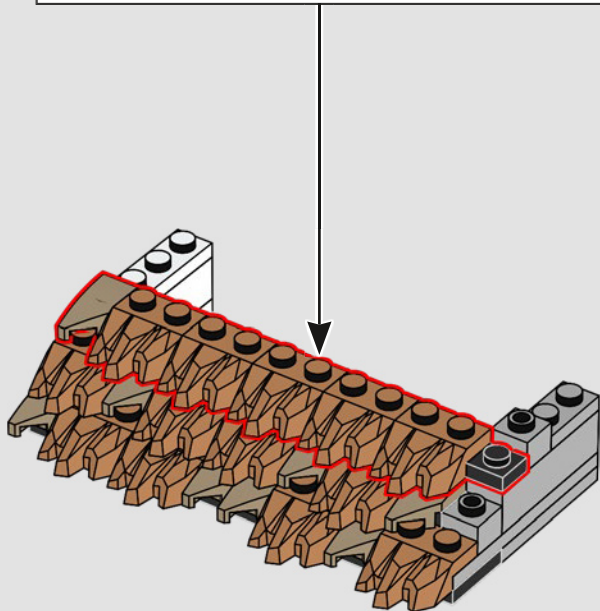
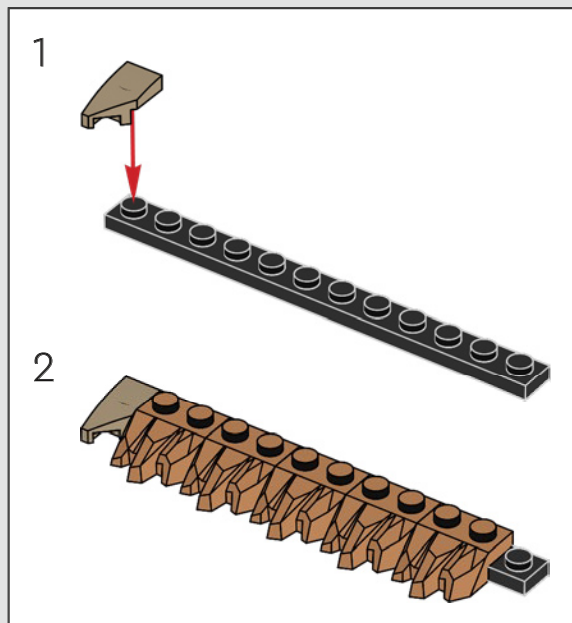

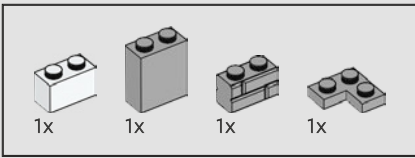

237

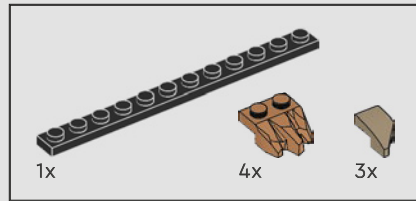
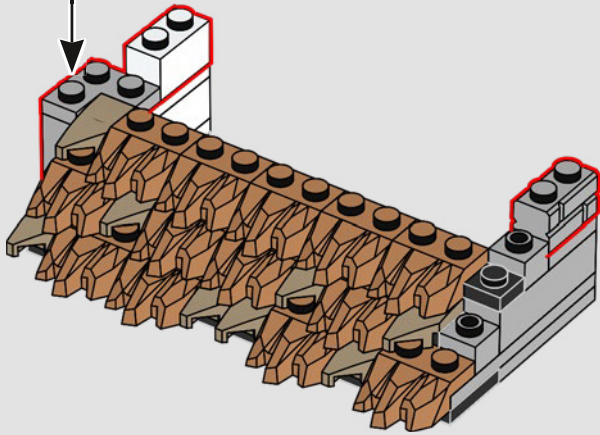
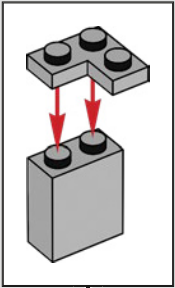

238

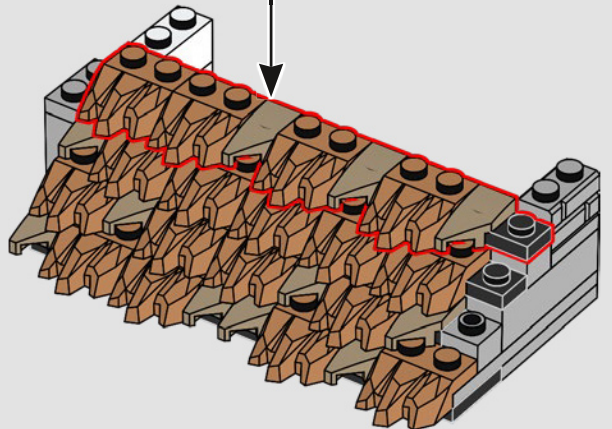
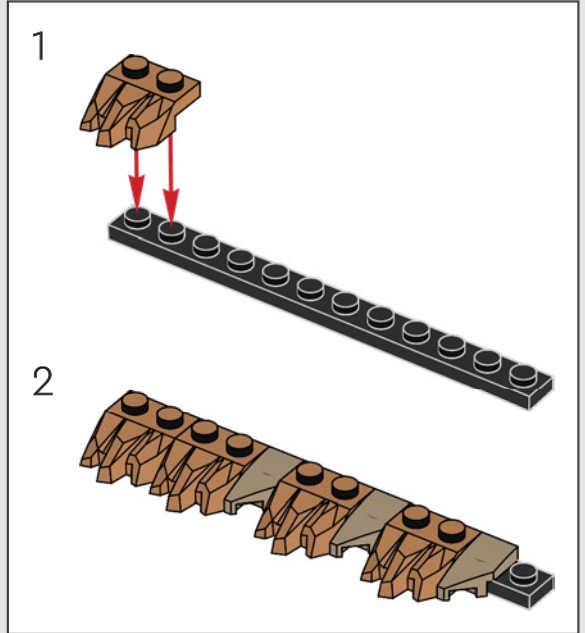

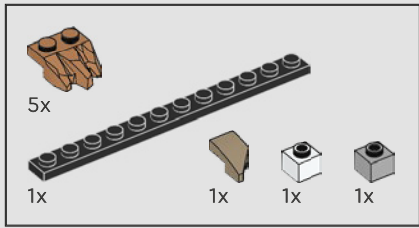

239

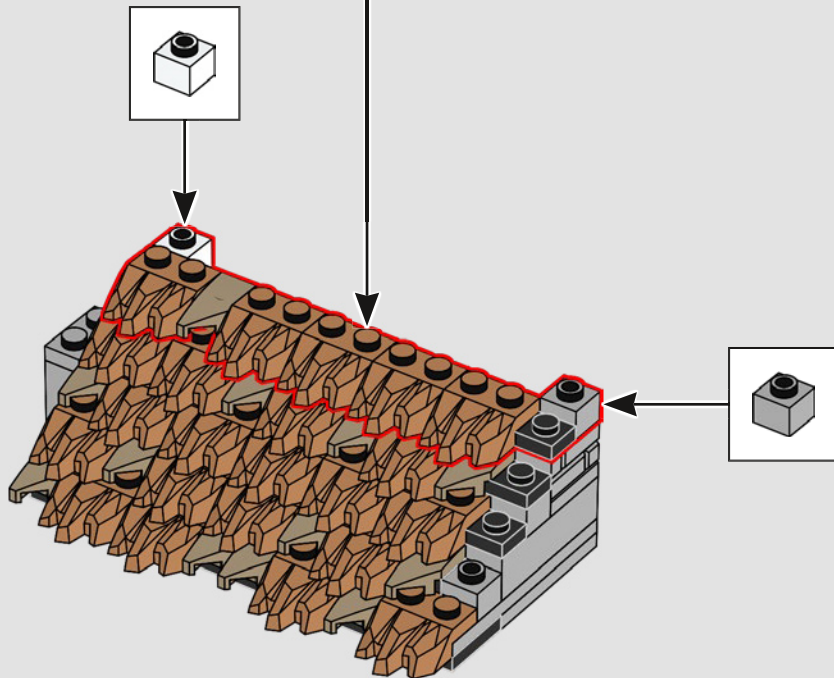
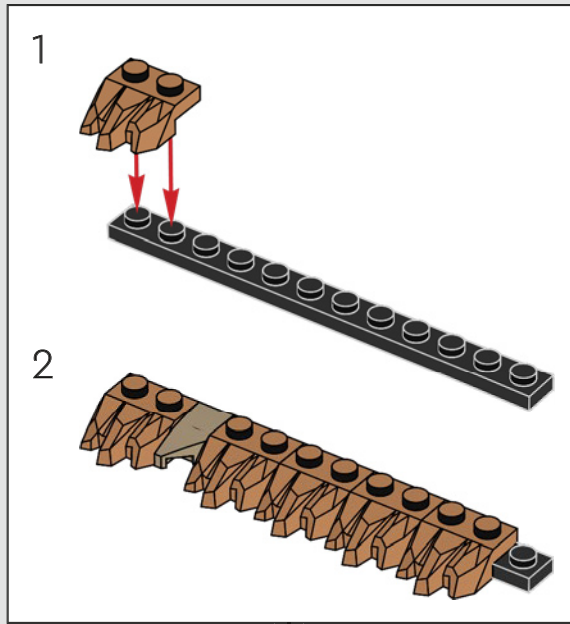

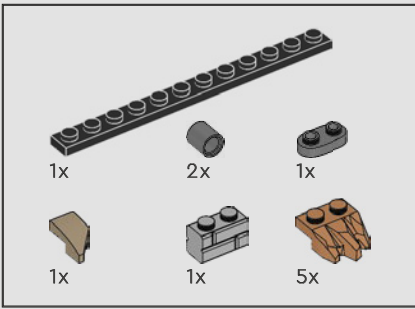

240

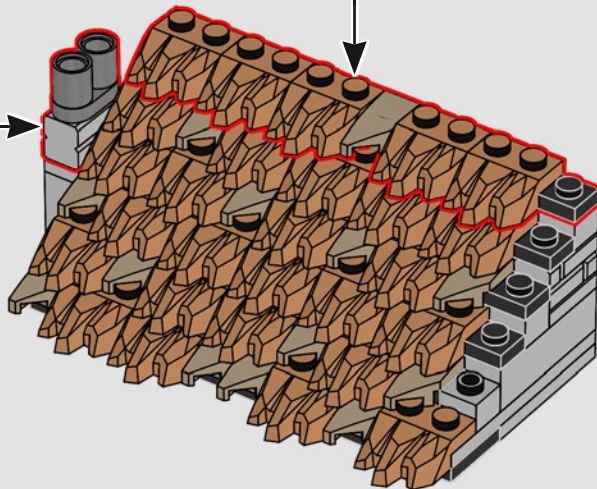
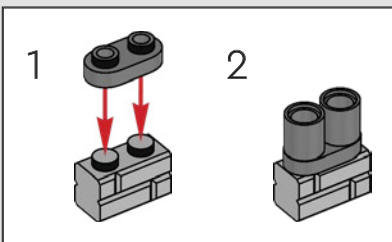
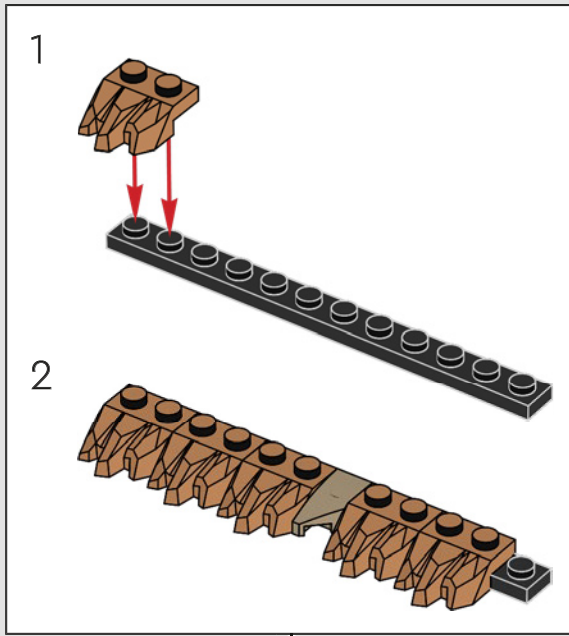

241

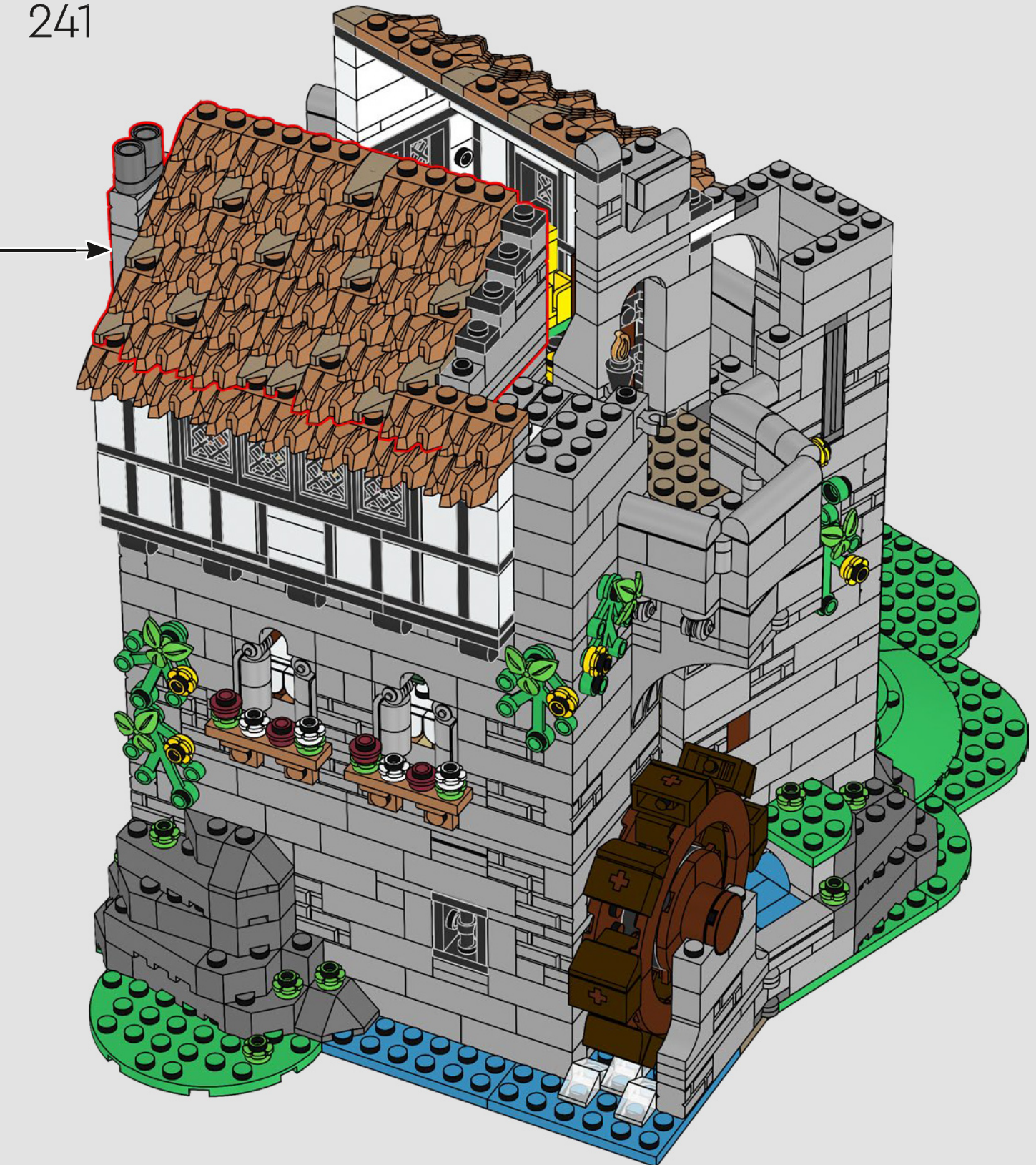

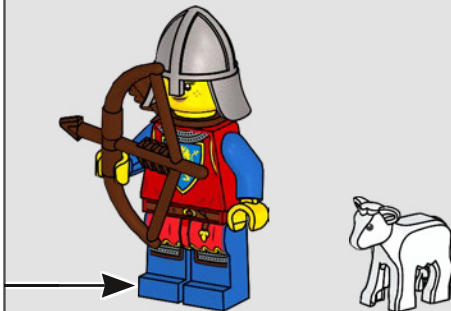
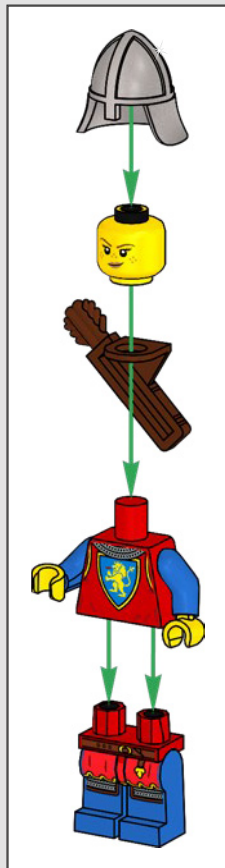

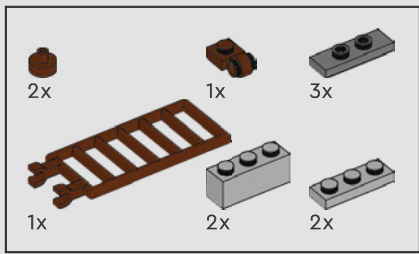

242

1

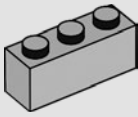

2

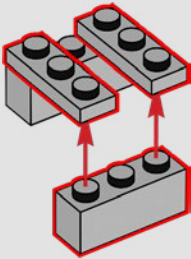

3

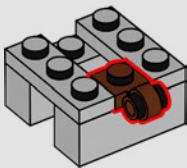

4

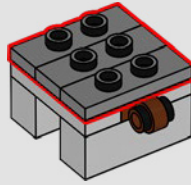

5

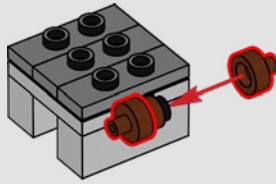

6

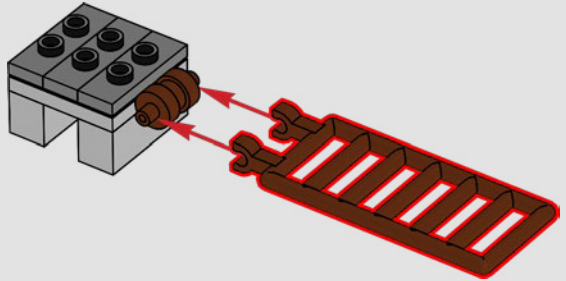

7

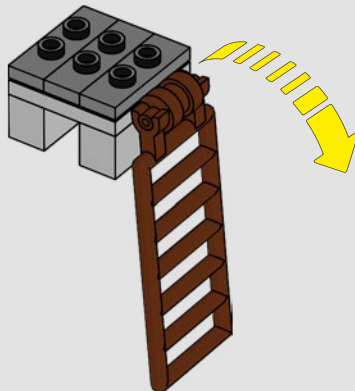



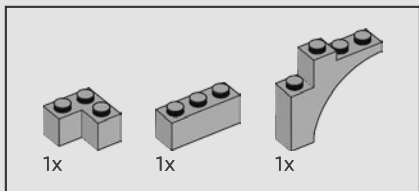

243



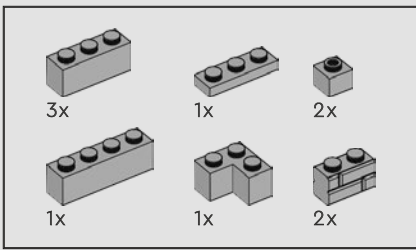

244

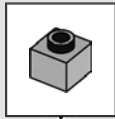
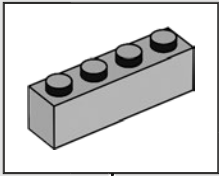

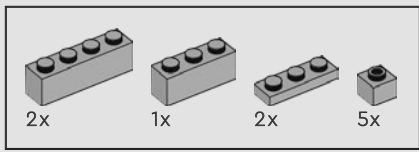

245



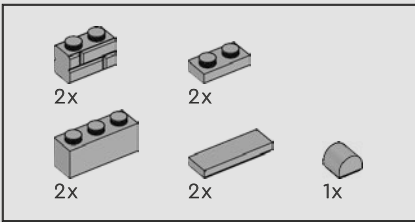

246

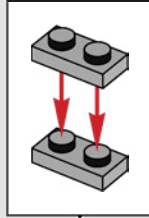

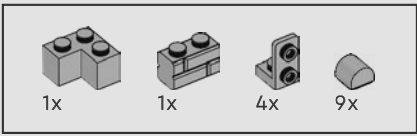

247

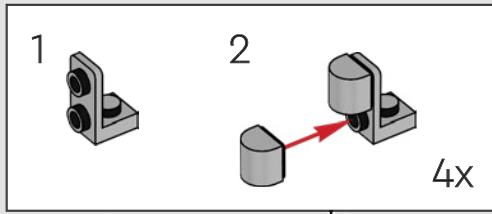

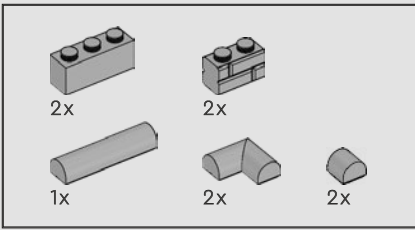

248



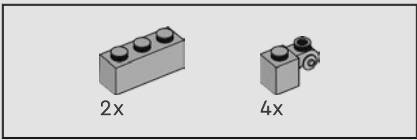

249



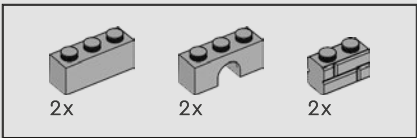

250



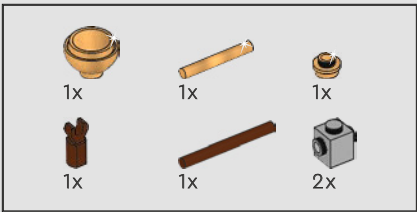

Cette cloche servira à prévenir les habitants de la ville si les maraudeurs du loup reviennent un jour...

251

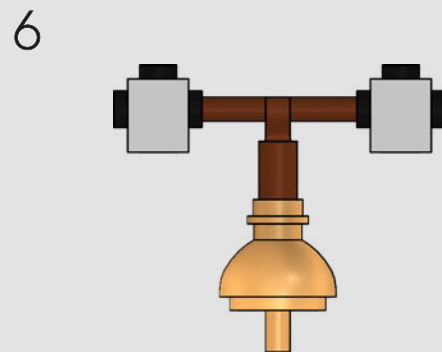
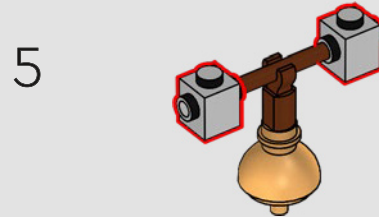
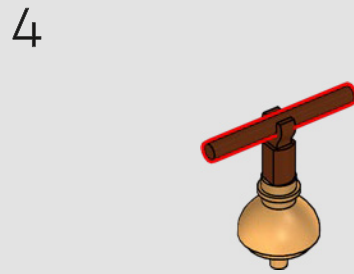
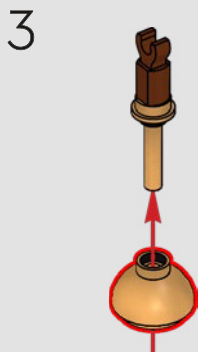
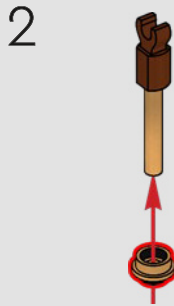
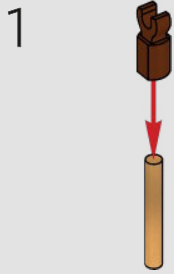

1:1



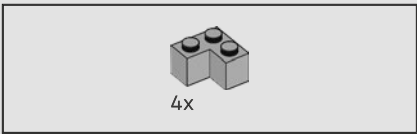

252





2x



4x

253



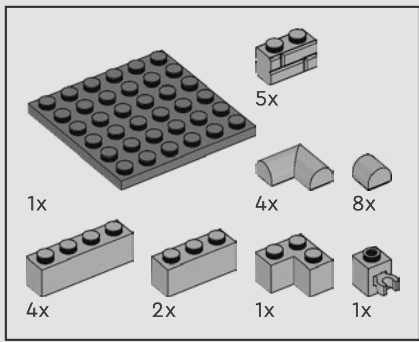

254

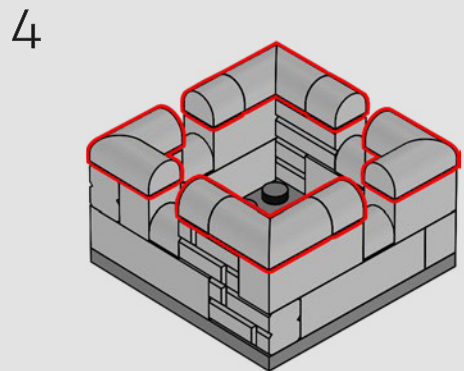
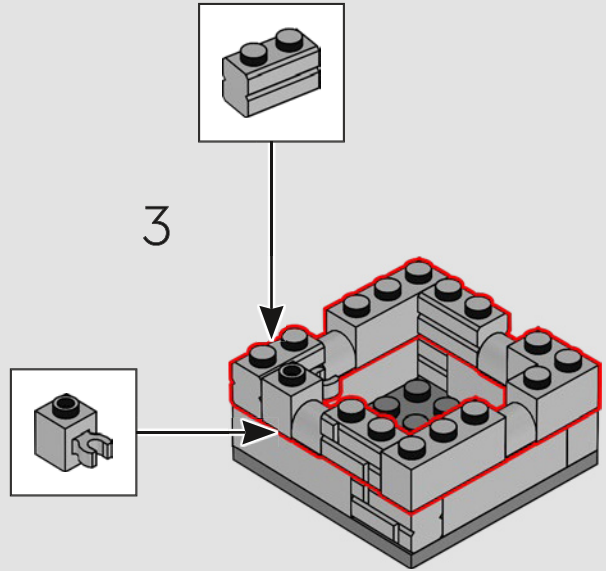
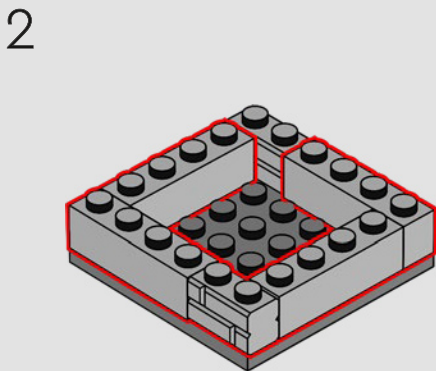
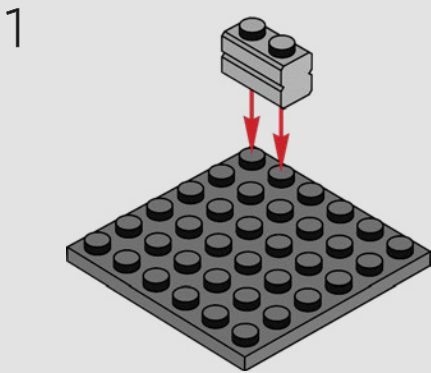



12x

255

12x



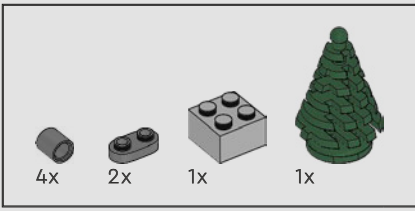

256

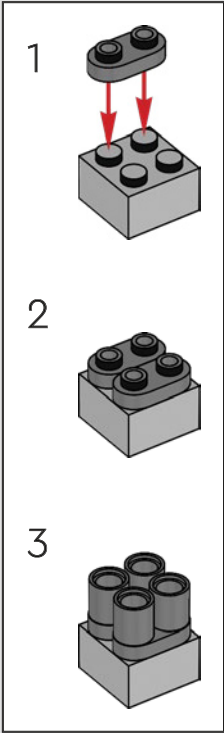

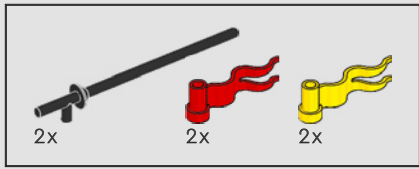

257

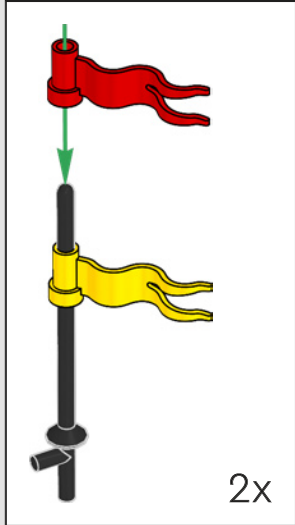

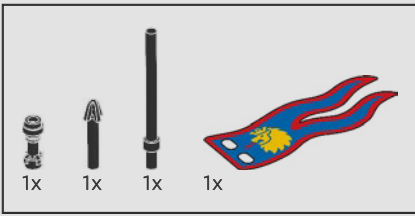

258

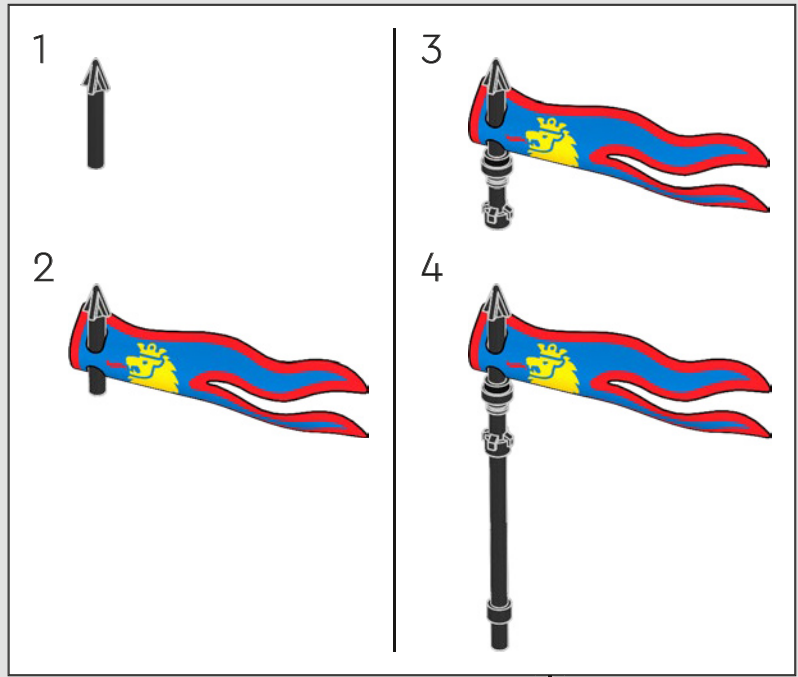



Ces pins sombres sont intéressants. Ils n'ont jamais été d'un vert aussi foncé...

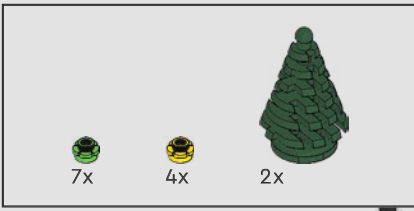

259

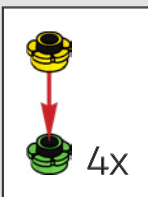

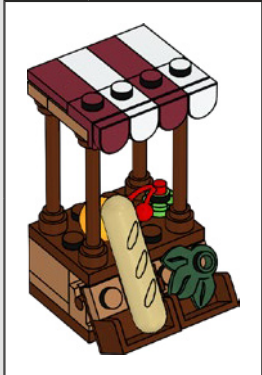

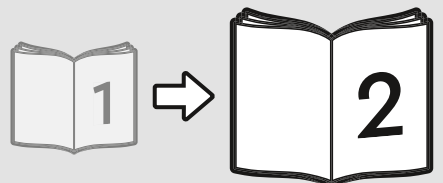



FEEDBACK AND WIN

FEEDBACK AND WIN

Your feedback will help shape the future development of this product series.

Please visit:

FEEDBACK UND GEWINNEN

Dein Feedback trägt zur Weiterentwicklung dieser Produktreihe bei.

Geh auf:

COMMENTEZ ET GAGNEZ

Vos commentaires nous aideront à concevoir les futurs produits de cette gamme.

Rendez-vous sur :

COMENTA Y GANA

Tu opinión nos ayudará a dar forma al desarrollo de esta serie de productos en el futuro.

Visita:

反馈有奖

您的反馈将有助于我们在今后改进本系列产品。

请访问：

[LEGO.com/productfeedback](https://www.lego.com/productfeedback)

By completing, you will automatically enter a drawing to win a LEGO® set.

Terms & Conditions apply.

Durch Ausfüllen nimmst du automatisch an der Verlosung eines LEGO® Preises teil.

Es gelten die Teilnahmebedingungen.

En envoyant vos commentaires, vous serez automatiquement inscrit(e) à un tirage au sort qui vous permettra de remporter un prix LEGO®.

Offre soumise à conditions.

Al contestar, participarás automáticamente en el sorteo y podrás ganar un set LEGO®.

Sujeto a Términos y Condiciones.

完成我们的反馈调查，即可自动进入抽奖环节，赢取乐高® 套装。

适用《条款和条件》。

